



I-7088(D)

M-7088(D)

8-channel PWM Output and 8-channel High-speed Counter Module

Features

- 8-channel PWM Output and 8-channel Counter Input
- Burst Mode and Continuous Mode for PWM Output
- Software and Hardware Trigger Mode for PWM Output
- Individual and Synchronous PWM Output
- High-speed Counters
- 4 kV ESD and EFT Protection
- Dual Watchdog
- Wide Operating Temperature Range: -25 to +75°C



Introduction

The I-7088 provides 8-channel PWM (Pulse Width Modulation) Output and 8-channel Counter Input, and can be used to develop powerful and cost-effective analog control systems. PWM is a powerful technique for controlling analog circuits that uses the Digital Output to generate a waveform with a variable duty cycle and frequency which can then be used to control an analog circuit in applications such as controlling the position or speed of motors, the brightness of lamps, or the speed of fans, etc. Either burst mode or continuous mode can be used for the PWM output depending on the application. In addition, all Digital Input channels can be used as high-speed counters with a speed of up to 1 MHz. The M-7088 supports both the Modbus RTU and the DCON protocols, which can be configured via software, and all hardware specifications are the same as the I-7088. The I-7088(D)/S and M-7088(D)/S allows the load voltage to be increased from +3.5 to +50 V for the 8-channels PWM (Pulse Width Modulation) output and the 8-channels high-speed counter.

Applications

- Controlling Motor Position/Speed
- Dimming Lamp Brightness
- Controlling Fan Speed

System Specifications

Model	I-7088	I-7088D	I-7088/S	I-7088D/S
	M-7088	M-7088D	M-7088/S	M-7088D/S
Communication				
Interface	RS-485			
Bias Resistor	No (Usually supplied by the RS-485 Master. Alternatively, add a tM-SG4 or SG-785.)			
Format	(N, 8, 1), (N, 8, 2), (E, 8, 1), (O, 8, 1)			
Baud Rate	1200 to 115200 bps			
Protocol	DCON Modbus RTU, DCON			
Dual Watchdog	Yes, Module (1.6 Seconds), Communication (Programmable)			
LED Indicators/Display				
System LED Indicator	Yes, 1 as Power/Communication Indicator			
I/O LED Indicators	7-segment			
7-segment LED Display	-	Yes	-	Yes
Isolation				
Intra-module Isolation, Field-to-Logic	2500 Vdc			
EMS Protection				
ESD (IEC 61000-4-2)	±4 kV Contact for each Terminal			
EFT (IEC 61000-4-4)	±4 kV for Power Line			
Surge (IEC 61000-4-5)	-			
Power				
Reverse Polarity Protection	Yes			
Input Range	+10 ~ +30 Vdc			
Consumption	2.9 W	3.4 W	2.9 W	3.4 W
Mechanical				
Dimensions (L x W x H)	123 mm x 72 mm x 35 mm			
Installation	DIN-Rail or Wall Mounting			
Environment				
Operating Temperature	-25 to +75°C			
Storage Temperature	-40 to +85°C			
Humidity	10 to 95% RH, Non-condensing			

I/O Specifications

Model	I-7088	I-7088D	I-7088/S	I-7088D/S
	M-7088	M-7088D	M-7088/S	M-7088D/S
Counter Input				
Channels	8			
Contact	Wet			
Sink/Source (NPN/PNP)	Sink			
ON Voltage Level	+3.5 ~ +5 Vdc		+3.5 ~ +50 Vdc	
OFF Voltage Level	+1 Vdc Max.		+1 Vdc Max.	
Programmable Filter	-			
Programmable Threshold Voltage	-			
Counter Bits	32-bit			
Counter Mode	Up			
Encoder Mode	-			
Frequency Mode	-			
Virtual Battery Backup	Yes			
Frequency Accuracy	-			
Max. Speed	1 MHz			
PWM Output				
Channels	8			
Type	PWM, TTL			
Sink/Source (NPN/PNP)	Sink			
Load Voltage	+5 Vdc		+5 ~ +50 Vdc	
Max. Load Current	Sink	+5 Vdc @ 10 mA/Channel	+50 Vdc @ 200 mA/Channel	
	Source	+5 Vdc @ 1 mA/Channel	-	
PWM	Frequency	1 Hz ~ 500 KHz		
	Duty Cycle	0.1 to 99.9%		
	Mode	Burst, Continuous		
	Burst Count	1 to 65535		
Trigger Start	Hardware or Software			
Power-on Value	-			
Safe Value	-			

Internal I/O Structure

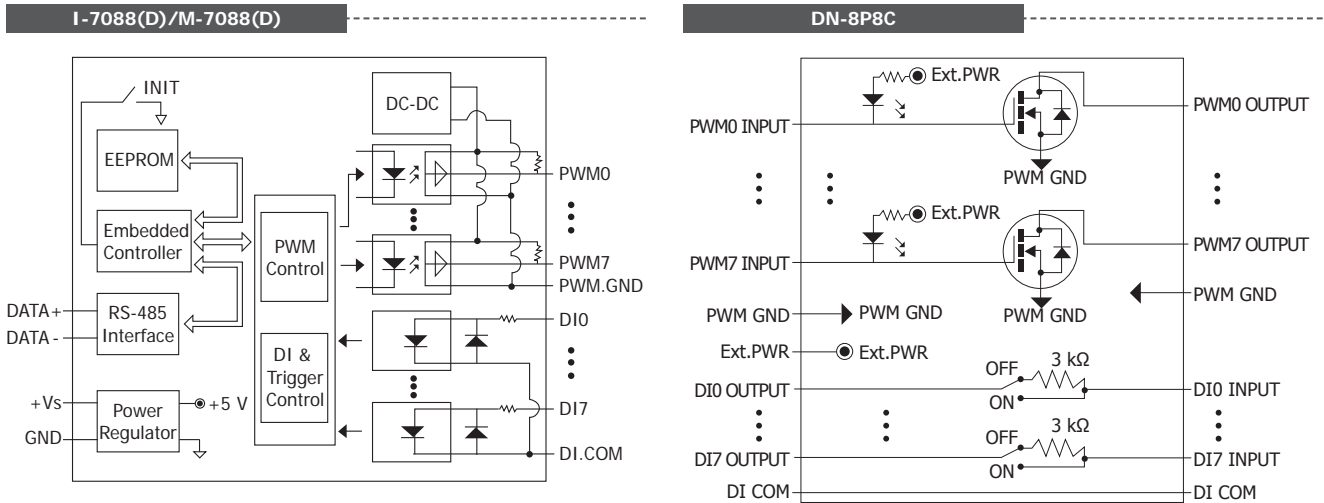

Wire Connections

I-7088(D)/M-7088(D)		
Counter Input	ON State Readback as 1 Relay ON	OFF State Readback as 0 Relay OFF
Relay Contact		
PWM Output	ON State Readback as 1	OFF State Readback as 0
Sink		
Source		

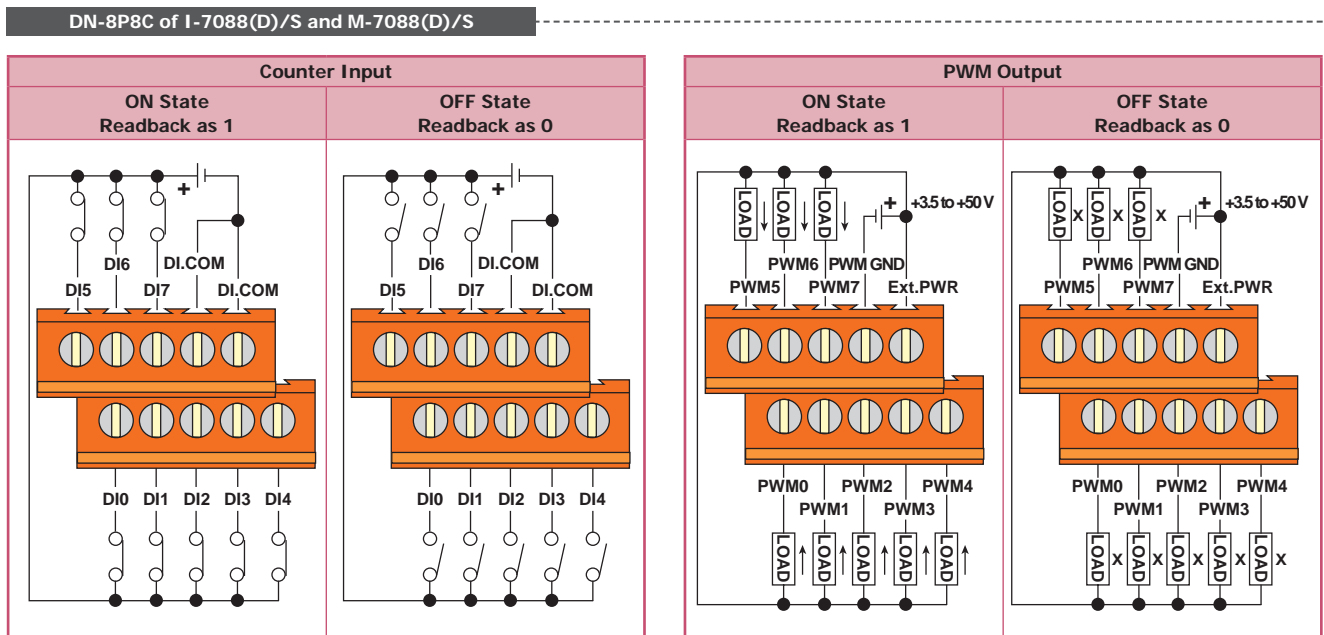

2
3
RS-485 Remote I/O Modules

I-7088/I-7088D/M-7088/M-7088D

Pin Assignments

I-7088(D)/M-7088(D)

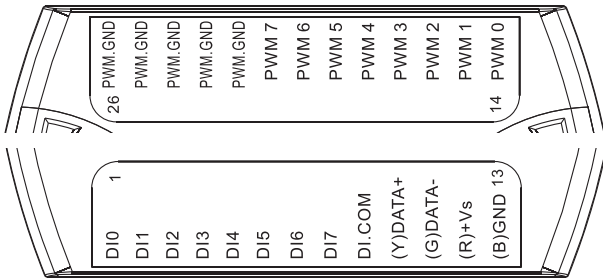

DN-8P8C of I-7088(D)/S and M-7088(D)/S

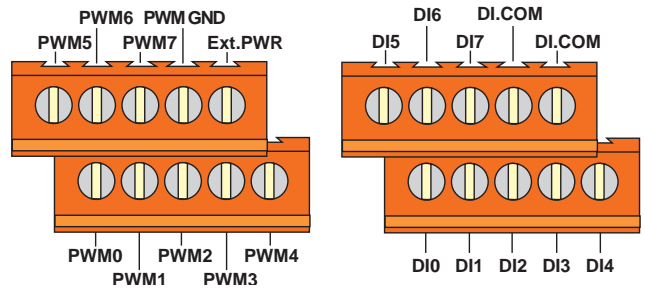

Applications

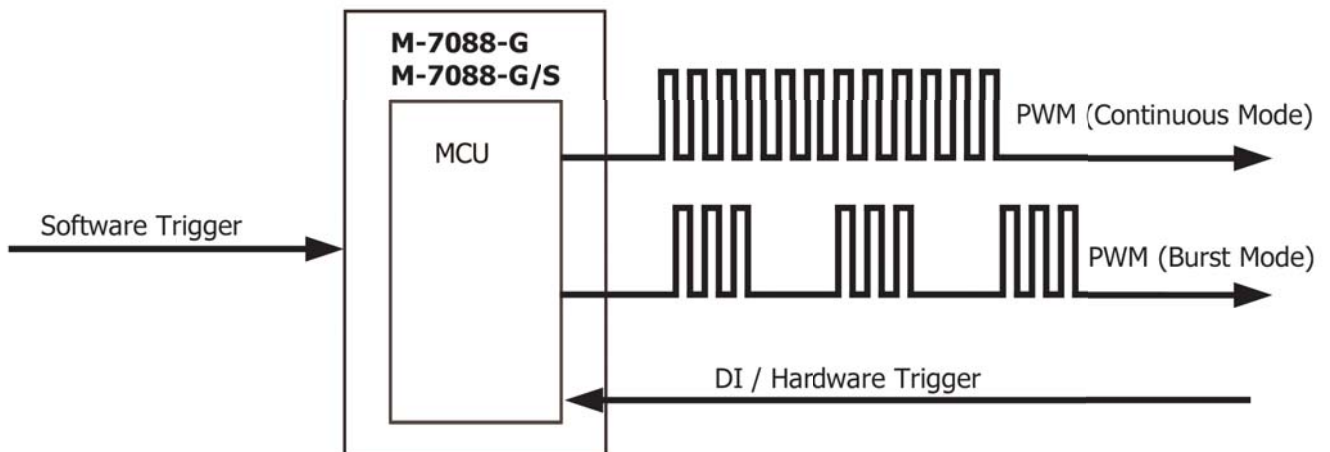
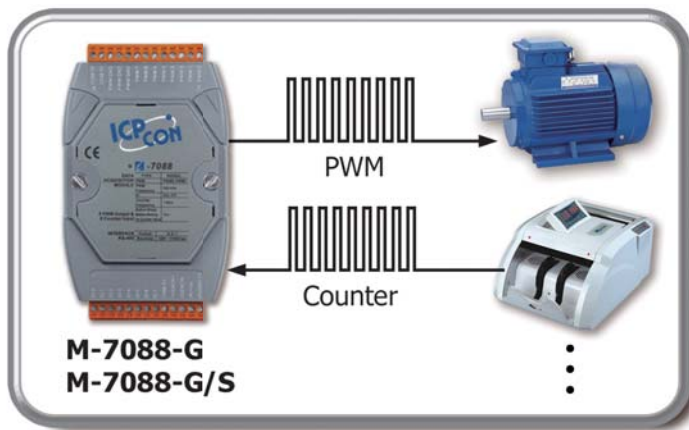
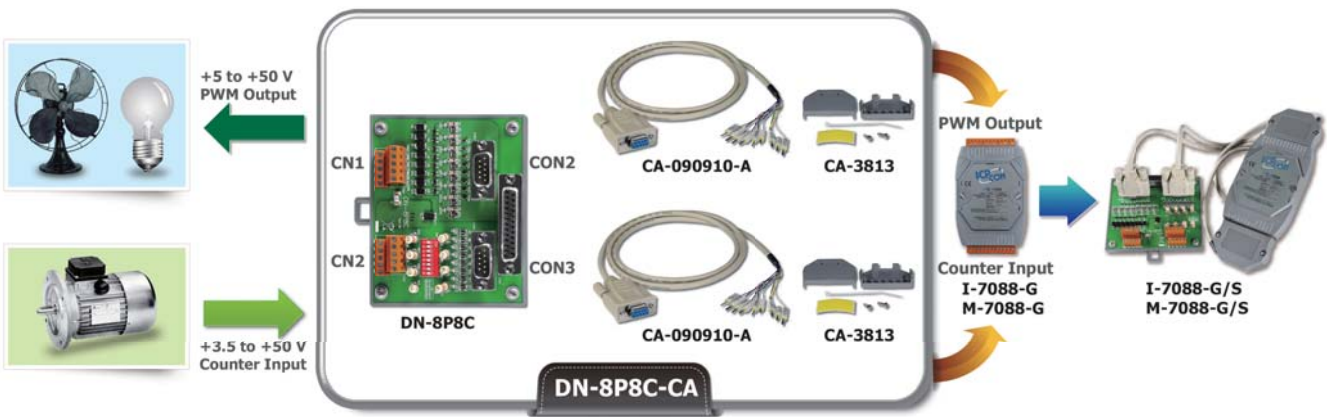

RS-485 Remote I/O Modules

2
3

I-7088/I-7088D/M-7088/M-7088D









Ordering Information

I-7088-G CR	8-channel PWM Output and 8-channel High-speed Counter Module using the DCON Protocol (Gray Cover) (RoHS)
I-7088D-G CR	I-7088 with 7-segment LED Display (Gray Cover) (RoHS)
M-7088-G CR	8-channel PWM Output and 8-channel High-speed Counter Module using the DCON and Modbus Protocols (Gray Cover) (RoHS)
M-7088D-G CR	M-7088 with 7-segment LED Display (Gray Cover) (RoHS)
I-7088-G/S CR	I-7088 with DN-8P8C-CA External Board (Gray Cover) (RoHS).
I-7088D-G/S CR	I-7088D with DN-8P8C-CA External Board (Gray Cover) (RoHS)
M-7088-G/S CR	M-7088 with DN-8P8C-CA External Board (Gray Cover) (RoHS).
M-7088D-G/S CR	M-7088D with DN-8P8C-CA External Board (Gray Cover) (RoHS)



I-7088-G/S = DN-8P8C-CA Connects to the I-7088 Directly
 M-7088-G/S = DN-8P8C-CA Connects to the M-7088 Directly

Accessories

	tM-7520U CR	RS-232 to RS-485 Converter (RoHS)
	tM-7561 CR	USB to RS-485 Converter (RoHS)
	tM-SG4 CR	RS-485 Bias and Termination Resistor Module (RoHS)
	I-7514U CR	4-channel RS-485 Hub (RoHS)
	SG-770 CR	7-channel Differential or 14-channel Single-ended Surge Protector (RoHS)
	DN-8P8C-CA CR	8-channel Digital Output and 8-channel Counter Input Board, including two CA-090910-A Cable and two CA-3813 Connector
	CA-090910-A	9-pin Female D-sub Cable for I/M-7088 Connector, 1 m
	CA-3813	Connector Casing for 13-pin, 3.81 mm Pitch or 14-pin, 3.5 mm Pitch.

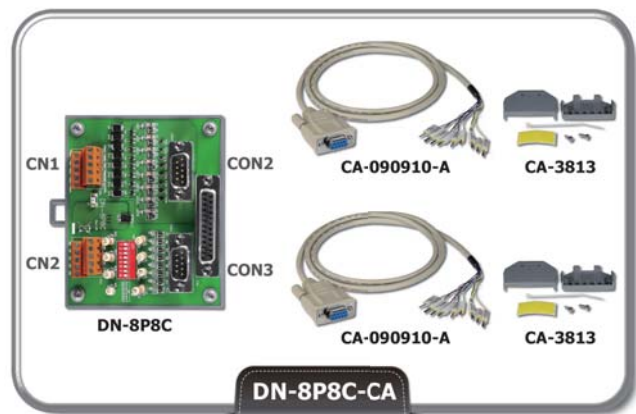

2
3

RS-485 Remote I/O Modules

I-7088/I-7088D/M-7088/M-7088D