DeviceNet Slave Device

CAN-2017D

Application User's Manual

Warranty

Without contrived damage, all products manufactured by ICP DAS are warranted in one year from the date of delivery to customers.

Warning

ICP DAS revises the manual at any time without notice. However, no responsibility is taken by ICP DAS unless infringement act imperils to patents of the third parties.

Copyright

Copyright © 2013 is reserved by ICP DAS.

Trademark

The brand name ICP DAS as a trademark is registered, and can be used by other authorized companies.

Contents

1	Introduction	3
1.1	Overview.....	3
1.2	Hardware Specifications	4
1.3	Features	5
1.4	Application.....	5
2	Hardware	5
2.1	Structure.....	5
2.2	Node ID & Baud Rate Rotary Switch	7
2.3	LED Description	8
2.4	Wire Connection.....	11
2.5	Internal I/O Structure.....	12
3	DeviceNet Profile Area	13
3.1	DeviceNet Statement of Compliance	13
3.2	Identity Object (Class ID: 0x01)	14
3.3	Connection Object (Class ID: 0x05)	15
3.4	Assembly Object (Class ID: 0x04).....	16
3.5	Application Object1 (Class ID: 0x64)	19
3.6	Application Object2 (Class ID: 0x65)	21
4	Application.....	22
	Appendix A: Dimension	25
	Appendix B: Type Code Definition	26

1 Introduction

1.1 Overview

DeviceNet is one kind of the network protocols based on the CAN bus and mainly used for embedded network system, such as industrial machine control , vehicle control system, factory automation, medical equipments control, remote data acquisition, environmental monitoring, and packaging machines control, etc.

The CAN-2017D follows DeviceNet specification Volume I/II, Release 2.0. Users can obtain the analog input data and configure the module via standard DeviceNet protocol. To build a connection between DeviceNet master and the CAN-2017D is no more a tough project. The DeviceNet EDS file would help user to achieve this purpose quickly and easily. The CAN-2017D module has 8 analog input channels for measuring voltage and current values. It can be fit to various applications. By using the DeviceNet masters of ICP DAS, users can simply build a DeviceNet network for their requirements.



1.2 Hardware Specifications

Analog Input:

- Input Channels: 8
- Input Type: $\pm 10V$, $\pm 5V$, $\pm 1V$, $\pm 500mV$, $\pm 150mV$, $-20mA \sim +20mA$ (External 125Ω Resistor is Required)
- Resolution: 16-bit
- Accuracy: $\pm 0.1\%$ FSR
- Sampling Rate: 10 Samples/ sec (Total)
- Zero Drift: $\pm 10\mu V/^\circ C$
- Span Drift: ± 25 ppm/ $^\circ C$
- Common Mode Rejection: 86 dB
- Normal Mode Rejection: 100 dB
- Input Impedance: >2 M Ω
- Over-voltage Protection: 240 Vrms
- Individual Channel Configuration: Yes
- Intra-module Isolation, Field to Logic: 3000 V_{DC}
- ESD Protection: ± 4 kV Contact for each terminal.

Others:

- Power LED: PWR (red)
- DeviceNet Status LED: NET/MOD, green/orange
- 8 LEDs as Upper Limit Alarm Indicators
- 8 LEDs as Lower Limit Alarm Indicators
- Power Supply: Unregulated $+10 \sim +30$ V_{DC}.
- Power Consumption: 2 W.
- Operating Temperature: $-25 \sim +75$ $^\circ C$.
- Storage Temperature: $-30 \sim +80$ $^\circ C$.
- Humidity: 10 to 90% RH, Non-condensing.
- Dimensions: 33 mm x 99 mm x 78 mm (W x L x H) .
- Switch for 120 Ω terminator resistor

1.3 Features

- DeviceNet general I/O slave device
- Comply with DeviceNet specification Volume I, Release 2.0 & Volume II, Release 2.0, Errata 5
- Group 2 Only Server (non UCMM-capable)
- Support Predefined Master/Slave Connection Set
- 1 connection for Explicit Messaging
- 1 connection for Polled I/O
- 1 connection for Bit-Strobe I/O connection
- Support DeviceNet heartbeat and shutdown messages
- Provide EDS file for standard DeviceNet master interface.
- NET, MOD and PWR LED indicators
- Baud Rate: 125k, 250k, 500k, selected by rotary switch.

1.4 Application

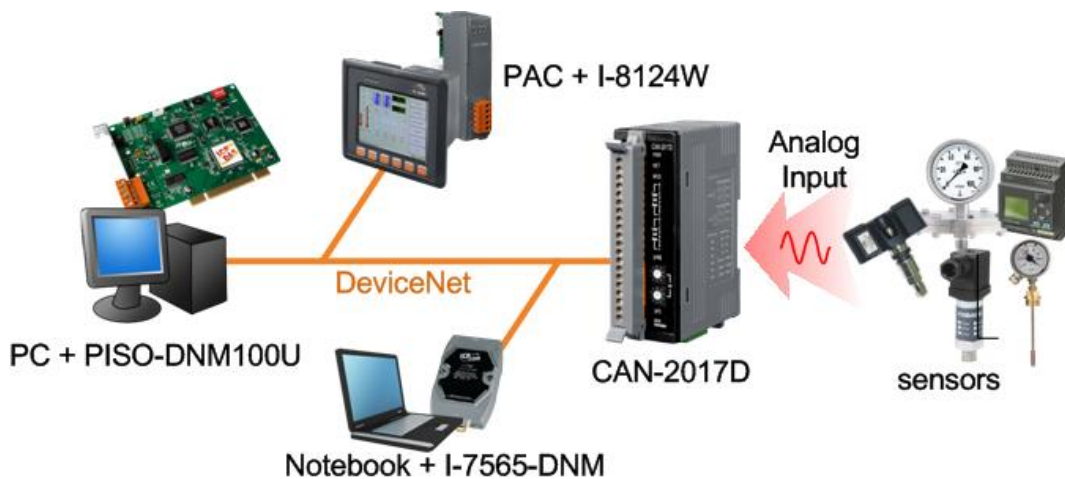

2 Hardware

2.1 Structure

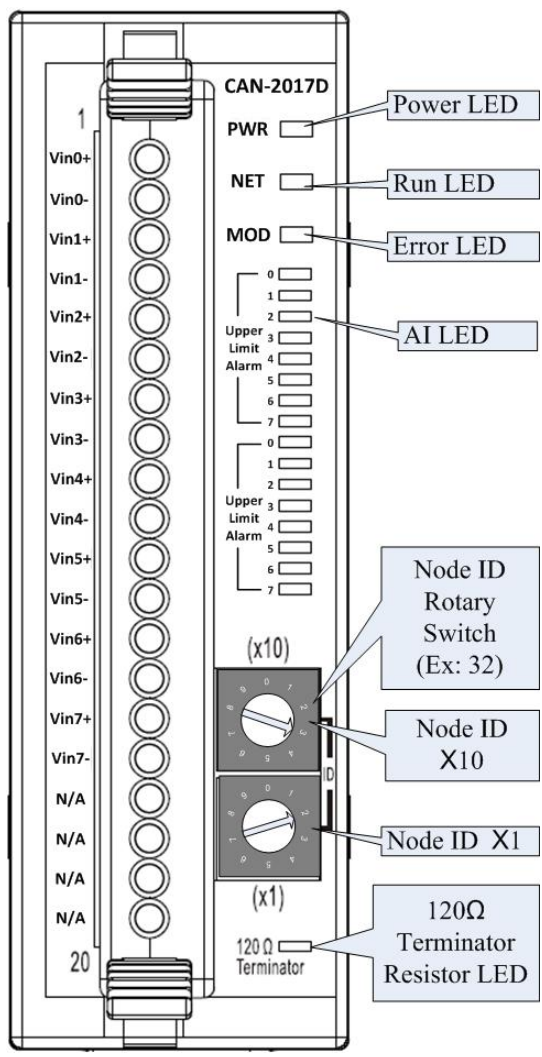

(Top View)

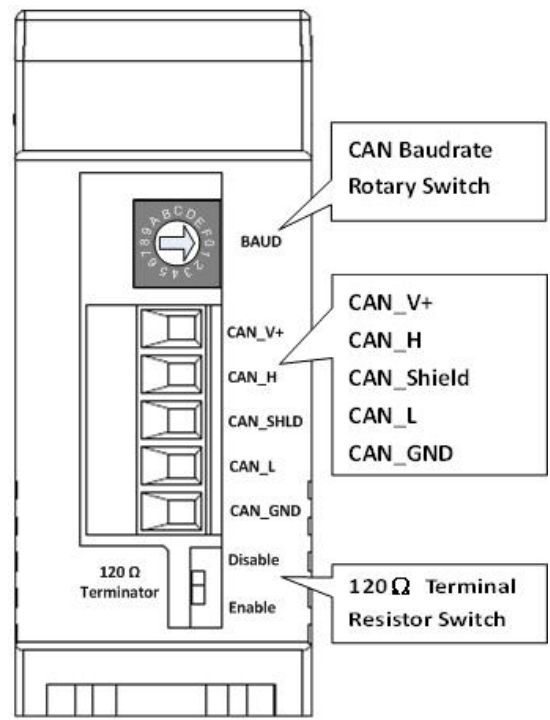

(Bottom View)

2.2 Node ID & Baud Rate Rotary Switch

The rotary switches for node ID configure the MAC ID of the CAN-2017D module. These two switches are for the tens digit and the units digit of MAC ID. The node ID value of this demo picture is 32.

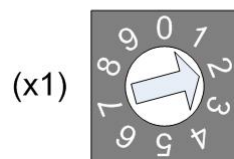
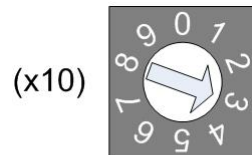

Node ID rotary switch

The rotary switch for baud rate configuration handles the CAN baud rate of the CAN-2017D module. The relationship between the rotary switch value and the practical baud rate is presented in the following table.



Baud rate rotary switch

Rotary Switch Value	Baud rate (k BPS)
0	125
1	250
2	500

Baud rate and rotary switch

2.3 LED Description

Power LED

The CAN-2017D needs a 10 ~ 30 V_{DC} power supply. Under a normal connection, a good power supply and a correct voltage selection, as the unit is turned on, the LED will be lighted up in red.

NET LED

The NET LED indicates the current status of the DeviceNet communication link.

Condition	Status	Indicates
Init Off	Offline	Device is not online
Off	Connection timeout	I/O connection timeout
Flashing	Online	Device is online, but not Communicating
Init solid	Link failed	(Critical) Device has detected an error that has rendered it incapable of communicating on the link; for example, detected a duplicate node address or network configuration error.
Solid	Online, communicating	Device is online and communicating.

MOD LED

This LED provides the devices status. It indicates whether or not the device is operating properly.

Condition	Status	Indicates
Off	Normal	
Solid	Critical fault	Device has unrecoverable fault.
Flashing	Non_critical fault	Device has recoverable fault to recover. If users want to fix the problem, reconfiguring device's MAC ID or resetting device may work.





















Terminal Resistor LED

When the switch of the 120Ω terminator resistor is turned on, the terminal resistor LED will be lightening.

Upper/Lower Limit Alarm LED

When the alarm trigger enable (Class ID: 0x64, Attribute ID: 0x04), trigger type (Class ID: 0x64, Attribute ID: 0x05) and upper/lower limit (Class ID: 0x64, Attribute ID: 0x06/0x07) had been setting and the analog voltage/current input has been over the upper limit or below lower limit, the upper/lower limit alarm LED will be turn on.

PIN Assignment

Terminal No.	Pin Assignment
	01 Vin 0 +
	02 Vin 0 -
	03 Vin 1 +
	04 Vin 1 -
	05 Vin 2 +
	06 Vin 2 -
	07 Vin 3 +
	08 Vin 3 -
	09 Vin 4 +
	10 Vin 4 -
	11 Vin 5 +
	12 Vin 5 -
	13 Vin 6 +
	14 Vin 6 -
	15 Vin 7 +
	16 Vin 7 -
	17 N/A
	18 N/A
	19 N/A
	20 N/A

CAN-2017D 20-pin Connector

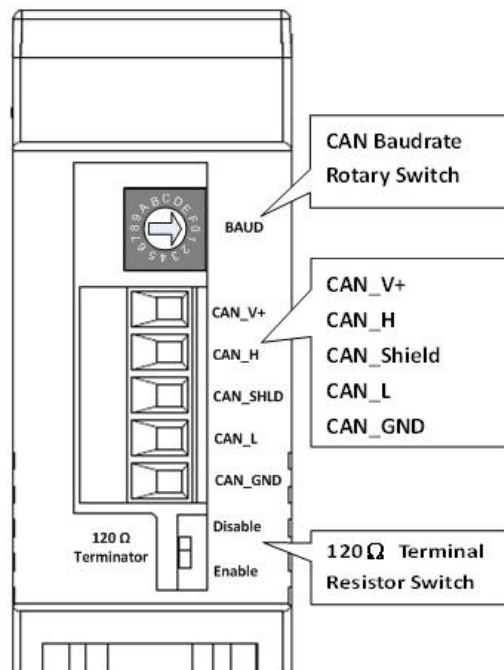

CAN-2017D CAN bus side Connector

2.4 Wire Connection

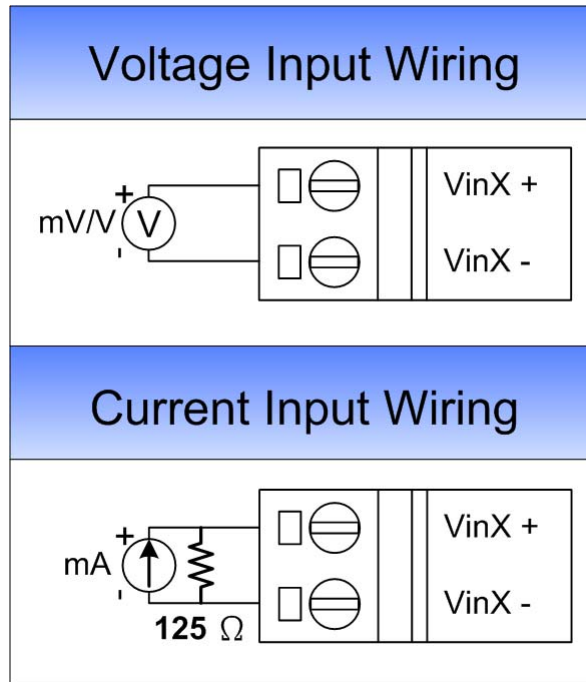

Note: When connecting to a current source, an external $125\ \Omega$ resistor is required.

2.5 Internal I/O Structure

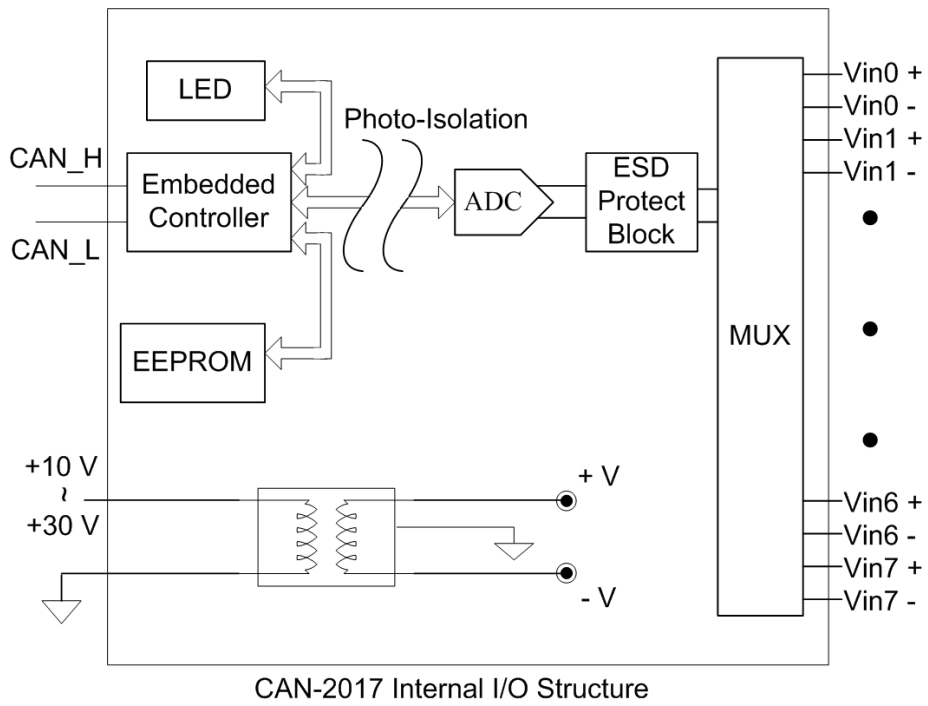

3 DeviceNet Profile Area

This section describes the detail functions for each object class that is implemented in the CAN-2017D DeviceNet net work.

3.1 DeviceNet Statement of Compliance

General Device Data

Device Information	Description
Version Description of DeviceNet Specification	Volume I, Release 2.0 & Volume II, Release 2.0
Vendor Name	ICP DAS
Device Profile Name	CAN-2017D
Production Revision	1.1

DeviceNet Physical Conformance Data

Item	Description
MAC ID Setting	Switch (0 ~ 63)
Communication Baud Rate Setting	Switch (125k, 250k, 500k)
Default Baud Rate	125kbps
Predefined Master/Slave Connection Set	Group 2 Only Server

3.2 Identity Object (Class ID: 0x01)

This Object provides the identification and general information about the device.

Class Attribute (Instance ID=0)

Attribute ID	Attribute Name	Data Type	Method	Value
0x01	Revision	UINT	Get	0001
0x02	Max Instance	UINT	Get	1

Class Service

Service Code	Attribute Name	Support
0x0E	Get_Attribute_Single	Yes

Instance Attribute (Instance ID=1)

Attribute ID	Description	Method	Data Type	Value
0x01	Revision	Get	UINT	803
0x02	Product type	Get	UINT	0x00
0x03	Product code	Get	UINT	0x301
0x04	Major. Minor of firmware version	Get	Struct of USINT USINT	1.1
0x05	Status	Get	WORD	-
0x06	Serial number	Get	UDINT	1
0x07	Product name	Get	Short_String	CAN-2017D
0x0A	Heartbeat Interval	Get/Set	USINT	0(default)

Instance Service

Service Code	Attribute Name	Support
0x0E	Get_Attribute_Single	Yes
0x10	Set_Attribute_Single	Yes
0x05	Reset	Yes

Note: Use the Instance Service 0x05 will reboot the device.

3.3 Connection Object (Class ID: 0x05)

This section presents the externally visible characteristics of the Connection Objects associated with the Predefined Master/Slave Connection Set within slave devices.

The following description is the default IO connection path.

Connection Path	Class ID	Instance ID	Attribute ID
Poll Produced	0x04	0x64	0x03
Poll Consumed	0x65	0x01	0x01
Bit Strobe Produced	0x04	0x64	0x03
Bit Strobe Consumed	0x65	0x01	0x01

Connection Instance ID	
0x01	References the Explicit Messaging Connection into the Server.
0x02	References the Poll I/O Connection.
0x03	References the Bit–Strobe I/O Connection.

3.4 Assembly Object (Class ID: 0x04)

The Assembly Object binds attributes of multiple objects which allows sending/receiving the data from/to each object over a single connection.

Assembly Objects can be used to bind input data or output data. The terms of “input” and “output” are defined from the network’s point of view. An input will produce data on the network and an output will consume data from the network.

Class Attribute (Instance ID=0)

Attribute ID	Attribute Name	Data Type	Method	Value
0x01	Revision	UINT	Get	0001
0x02	Max Instance	UINT	Get	0x08

Class Service

Service Code	Attribute Name	Support
0x0E	Get_Attribute_Single	Yes

Instance ID

Instance ID	OUTPUT	INPUT
0x64		Get Channel 0~7 AI value
0x65	Set Channel 0~7 AI type code	Get Channel 0~7 AI type code
0x66	Set Channel 0~7 AI Trigger Enable	Get Channel 0~7 AI Trigger Enable
0x67	Set Channel 0~7 AI Trigger Type Code	Get Channel 0~7 AI Trigger Type Code
0x68	Set Channel 0~7 AI Trigger upper limit	Get Channel 0~7 AI Trigger upper limit
0x69	Set Channel 0~7 AI Trigger lower limit	Get Channel 0~7 AI Trigger lower limit
0x6A		Get Channel 0~7 AI Trigger status
0x6B	Set Channel 0~7 AI Offset	Get Channel 0~7 AI Offset

Note: About the definition of the type codes, please refer to appendix B for details.

Contents of Each Assembly Object Instance

Instance ID	Description	Type	Method	Default Value
0x64	Channel 0~7 AI Values	short	Get	0x0000
0x65	Channel 0~7 AI Type Codes	unsigned char	Get/Set	0x08

0x66	Channel 0~7 AI Trigger Enable	unsigned char	Get/Set	0x00
0x67	Channel 0~7 AI Trigger Type	unsigned char	Get/Set	0x00
0x68	Channel 0~7 AI Upper Limit	short	Get/Set	0x7FFF
0x69	Channel 0~7 AI Lower Limit	short	Get/Set	0x8000
0x6A	Channel 0~7 AI Trigger Status	unsigned char	Get	0x00
0x6B	Channel 0~7 AI Offset	short	Get/Set	0x0000

Parameter description of Assembly Object Instance

Instance ID	Data Range	Parameter Description								
0x64	Refer to appendix B for the corresponding input values.	Channel 0~7 AI Values.								
0x65	Refer to appendix B for the Type Codes definition.	Channel 0~7 AI Type Codes.								
0x66	0x00: disable trigger alarm. 0x01: enable trigger alarm.	Channel 0~7 AI Trigger Enable.								
0x67	Trigger Type: <table border="1"> <tr> <td>Bit no.</td> <td>7 ~ 2</td> <td>1</td> <td>0</td> </tr> <tr> <td>Status</td> <td>Reserved</td> <td>lower level trigger</td> <td>upper level trigger</td> </tr> </table>	Bit no.	7 ~ 2	1	0	Status	Reserved	lower level trigger	upper level trigger	Channel 0~7 AI Trigger Type. Please refer to the table in the left hand for configuration of the trigger type.
Bit no.	7 ~ 2	1	0							
Status	Reserved	lower level trigger	upper level trigger							
0x68	0x0000~0xFFFF Refer to the Appendix B for the range of the value.	Channel 0~7 AI Upper Limit value. 0x0000 ~ 0x7FFF => 0 ~ +32767 0xFFFF ~ 0x8000 => -1 ~ -32768								
0x69	0x0000~0xFFFF Refer to the Appendix B for the range of the value.	Channel 0~7 AI Lower Limit value. 0x0000 ~ 0x7FFF => 0 ~ +32767 0xFFFF ~ 0x8000 => -1 ~ -32768								
0x6A	Trigger Status: <table border="1"> <tr> <td>Bit no.</td> <td>7 ~ 2</td> <td>1</td> <td>0</td> </tr> <tr> <td>Status</td> <td>Reserved</td> <td>lower level trigger</td> <td>upper level trigger</td> </tr> </table>	Bit no.	7 ~ 2	1	0	Status	Reserved	lower level trigger	upper level trigger	Channel 0~7 AI Trigger Status. Please refer to the table in the left hand for configuration of the trigger type.
Bit no.	7 ~ 2	1	0							
Status	Reserved	lower level trigger	upper level trigger							
0x6B	0x0000~0xFFFF Refer to the Appendix B for the range of the value.	Channel 0~7 AI offset value. 0x0000 ~ 0x7FFF => 0 ~ +32767 0xFFFF ~ 0x8000 => -1 ~ -32768								

Instance Attribute (Instance ID=0x64~0x6A)

Attribute ID	Description	Method	DeviceNet Data Type	Value
0x03	Data	Get/Set	OUTPUT/INPUT	Dependent on instance ID.

Instance Service

Service Code	Attribute Name	Support
0x0E	Get_Attribute_Single	Yes
0x10	Set_Attribute_Single	Yes

3.5 Application Object1 (Class ID: 0x64)

Application objects are the interfaces between an application and the DeviceNet Layer. The attributes of application Objects contain the data for the application, which are accessed and exchanged via the DeviceNet protocol. A DeviceNet device accesses application data by invoking read and write functions. These functions need to be provided by an Application Object. The DeviceNet protocol provides Get_Attribute_Single and Set_Attribute_Single to read and write the single AI channel configuration of the CAN-2017D module.

Class Attribute (Instance ID=0)

Attribute ID	Attribute Name	Data Type	Method	Value
0x01	Revision	UINT	Get	0001
0x02	Max Instance	UINT	Get	0x08

Class Service

Service Code	Attribute Name	Support
0x0E	Get_Attribute_Single	Yes

Instance ID

Instance ID	Description
0x01	For accessing channel 0 AI configuration
0x02	For accessing channel 1 AI configuration
0x03	For accessing channel 2 AI configuration
0x04	For accessing channel 3 AI configuration
0x05	For accessing channel 4 AI configuration
0x06	For accessing channel 5 AI configuration
0x07	For accessing channel 6 AI configuration
0x08	For accessing channel 7 AI configuration

Instance Attribute (Instance ID=0x01~0x08)

Attribute ID	Description	Type	Method	Default Value
0x01	Channel 0~7 AI Values	short	Get	0x0000
0x02	Channel 0~7 AI Type Codes	unsigned char	Get/Set	0x08
0x03	Channel 0~7 AI Trigger Enable	unsigned char	Get/Set	0x00

0x04	Channel 0~7 AI Trigger Type	unsigned char	Get/Set	0x00
0x05	Channel 0~7 AI Upper Limit	short	Get/Set	0x7FFF
0x06	Channel 0~7 AI Lower Limit	short	Get/Set	0x8000
0x07	Channel 0~7 AI Trigger Status	unsigned char	Get	0x00
0x08	Channel 0~7 AI Offset	short	Get/Set	0x0000

Parameter description of Application Object1 Attributes

Attribute ID	Data Range	Parameter Description								
0x01	Refer to appendix B for the corresponding input values.	Channel 0~7 AI Values.								
0x02	Refer to appendix B for the Type Codes definition.	Channel 0~7 AI Type Codes.								
0x03	0x00: disable trigger alarm. 0x01: enable trigger alarm.	Channel 0~7 AI Trigger Enable.								
0x04	Trigger Type: <table border="1" style="width: 100%; border-collapse: collapse;"> <tr> <td style="width: 15%;">Bit no.</td> <td style="width: 25%;">7 ~ 2</td> <td style="width: 15%;">1</td> <td style="width: 15%;">0</td> </tr> <tr> <td>Status</td> <td>Reserved</td> <td>lower level trigger</td> <td>upper level trigger</td> </tr> </table>	Bit no.	7 ~ 2	1	0	Status	Reserved	lower level trigger	upper level trigger	Channel 0~7 AI Trigger Type. Please refer to the table in the left hand for configuration of the trigger type.
Bit no.	7 ~ 2	1	0							
Status	Reserved	lower level trigger	upper level trigger							
0x05	0x0000~0xFFFF Refer to the Appendix B for the range of the value.	Channel 0~7 AI Upper Limit value. 0x0000 ~ 0x7FFF => 0 ~ +32767 0xFFFF ~ 0x8000 => -1 ~ -32768								
0x06	0x0000~0xFFFF Refer to the Appendix B for the range of the value.	Channel 0~7 AI Lower Limit value. 0x0000 ~ 0x7FFF => 0 ~ +32767 0xFFFF ~ 0x8000 => -1 ~ -32768								
0x07	Trigger Status: <table border="1" style="width: 100%; border-collapse: collapse;"> <tr> <td style="width: 15%;">Bit no.</td> <td style="width: 25%;">7 ~ 2</td> <td style="width: 15%;">1</td> <td style="width: 15%;">0</td> </tr> <tr> <td>Status</td> <td>Reserved</td> <td>lower level trigger</td> <td>upper level trigger</td> </tr> </table>	Bit no.	7 ~ 2	1	0	Status	Reserved	lower level trigger	upper level trigger	Channel 0~7 AI Trigger Status. Please refer to the table in the left hand for configuration of the trigger type.
Bit no.	7 ~ 2	1	0							
Status	Reserved	lower level trigger	upper level trigger							
0x08	0x0000~0xFFFF Refer to the Appendix B for the range of the value.	Channel 0~7 AI offset value. 0x0000 ~ 0x7FFF => 0 ~ +32767 0xFFFF ~ 0x8000 => -1 ~ -32768								

Instance Service

Service Code	Attribute Name	Support
0x0E	Get_Attribute_Single	Yes
0x10	Set_Attribute_Single	Yes

3.6 Application Object2 (Class ID: 0x65)

Application Object2 defines parameters for saving configurations into EEPROM or loading factory default setting.

Class Attribute (Instance ID=0)

Attribute ID	Attribute Name	Data Type	Method	Value
0x01	Revision	UINT	Get	0001
0x02	Max Instance	UINT	Get	0x01

Class Service

Service Code	Attribute Name	Support
0x0E	Get_Attribute_Single	Yes

Instance Attribute (Instance ID=0x01)

Attribute ID	Description	Type	Method	Default Value
0x01	Save all configurations into EEPROM or using factory default configuration setting	USINT	Set	-

Parameter description of Application Object2 Attributes

Attribute ID	Data Range	Parameter Description
0x01	0x01: Use default configuration. 0x02: Save all configurations to EEPROM.	0x01: After restarting the device, all configurations will become default setting. 0x02: Save all channels configuration into EEPROM

Instance Service

Service Code	Attribute Name	Support
0x10	Set_Attribute_Single	Yes

4 Application

Application Object (Class ID:0x64, 0x65) lists all the parameters of the module. Each Instance ID is corresponding to the different channel. By using “Set/Get_Attribute_Single” service, users can read/write the parameters of each channel.

Example1:

Get AI value of channel 0.

(ClassID:0x64, Instance ID: 0x01, Attribute ID: 0x01)

If the node ID of the CAN-2017D is 0x01, and the master (ID: 0x0A) has completed “Explicit” connection with the device. By getting the value of the object with attribute ID 0x01, users can get the channel 0 of the AI data.

IDENTIFIER BITS											RTR	Data Length	8-byte Data (byte)							
Destination MAC ID													(HEX)							
10	9	8	7	6	5	4	3	2	1	0			0	1	2	3	4	5	6	7
1	1	0	0	0	0	0	1	1	0	0	0	5	0A	0E	64	01	01	00	00	00

Master



Slave
(CAN-2017D)

IDENTIFIER BITS											RTR	Data Length	8-byte Data (byte)							
Source MAC ID													(HEX)							
10	9	8	7	6	5	4	3	2	1	0			0	1	2	3	4	5	6	7
1	0	0	0	0	0	0	1	0	1	1	0	4	0A	8E	FF	7F	--	--	--	--

Master



Slave
(CAN-2017D)

Get the value of Application Object1 with Instance ID 0x01 and Attribute ID 0x01.

After sending the “Get_Attribute_Single”, the slave device responds the AI data. The value 0x7FFF means that the channel 0’s input data is 0x7FFF. About the meaning of the AI value, refer to the appendix B for the AI data and type code definition.

Example2:

Upper Level Alarm Trigger for Channel 0.

If the node ID of the CAN-2017D is 0x01, and the master (ID: 0x0A) has completed “Explicit” connection with the device. When channel 0 AI value over the upper limit, the user can watch the upper alarm limit LED indication turn on via setting the parameter of the object with attribute ID 0x03,0x04,0x05.

1. Set Trigger Enable

(Class ID: 0x64, Instance ID: 0x01, Attribute ID: 0x03)

IDENTIFIER BITS											RTR	Data Length	8-byte Data (byte) (HEX)							
Destination MAC ID																				
10	9	8	7	6	5	4	3	2	1	0			0	1	2	3	4	5	6	7
1	1	0	0	0	0	0	1	1	0	0	0	6	0A	10	64	01	03	01	00	00



IDENTIFIER BITS											RTR	Data Length	8-byte Data (byte) (HEX)							
Source MAC ID																				
10	9	8	7	6	5	4	3	2	1	0			0	1	2	3	4	5	6	7
1	0	1	1	0	0	0	0	0	0	1	0	2	0A	90	--	--	--	--	--	--



Set the value 0x01 to the Application Object1 with Instance ID 0x01 and Attribute ID 0x03. After sending the “Set_Attribute_Single”, the slave device will response 0x09 to means that the setting is OK. Then the Alarm Trigger will become to “Enable” mode. Setting the value 0x00 to this attribute will disable the Alarm Trigger.

2. Trigger Type Setting

(Class ID: 0x64, Instance ID: 0x01, Attribute ID: 0x04)

IDENTIFIER BITS											RTR	Data Length	8-byte Data (byte) (HEX)							
Destination MAC ID																				
10	9	8	7	6	5	4	3	2	1	0			0	1	2	3	4	5	6	7
1	1	0	0	0	0	0	1	1	0	0	0	6	0A	10	64	01	04	01	00	00

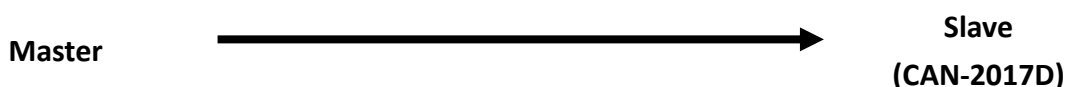

IDENTIFIER BITS											RTR	Data Length	8-byte Data (byte) (HEX)							
Source MAC ID													0	1	2	3	4	5	6	7
10	9	8	7	6	5	4	3	2	1	0										
1	0	1	1	0	0	0	0	0	0	1	0	2	0A	90	--	--	--	--	--	



Set the value 0x01 to the Application Object1 with Instance ID 0x01 and Attribute ID 0x04. After sending the "Set_Attribute_Single", the slave device will response 0x09 to means that the setting is OK. Then the Trigger Type will become to "Upper Level Trigger" mode. Setting the value 0x01 to this attribute will enter the "Lower Level Trigger". Setting the value 0x03 to this attribute will both of them. Setting the value 0x0 to this attribute will be no trigger.

Bit no.	7 ~ 2	1	0
Status	Reserved	lower level trigger	upper level trigger

3. Upper Limit value Setting

(Class ID: 0x64, Instance ID: 0x01, Attribute ID: 0x05)

IDENTIFIER BITS											RTR	Data Length	8-byte Data (byte) (HEX)							
Destination MAC ID													0	1	2	3	4	5	6	7
10	9	8	7	6	5	4	3	2	1	0										
1	1	0	0	0	0	0	1	1	0	0	0	7	0A	10	64	01	05	FF	3F	00

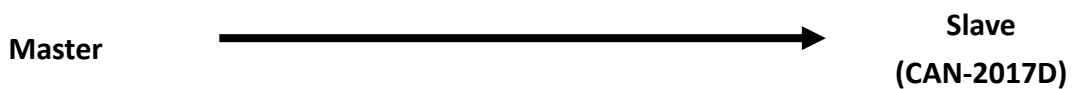

IDENTIFIER BITS											RTR	Data Length	8-byte Data (byte) (HEX)							
Source MAC ID													0	1	2	3	4	5	6	7
10	9	8	7	6	5	4	3	2	1	0										
1	0	1	1	0	0	0	0	0	0	1	0	2	0A	90	--	--	--	--	--	



Set the value 0x3FFF to the Application Object1 with Instance ID 0x01 and Attribute ID 0x05. After sending the "Set_Attribute_Single", the slave device will response 0x09 to means that the setting is OK. When channel 0 AI value over the 0x3FFF, the upper alarm LED will be turn on. The Attribute 0x05 of Application Object1 can use to set upper alarm limit. The value 0x0000 ~ 0x7FFF means the AI value plus 0 ~ 32767. The value 0xFFFF ~ 0x8000 means the AI data plus -1 ~ -32768.

Appendix A: Dimension

CAN-2017D dimension:

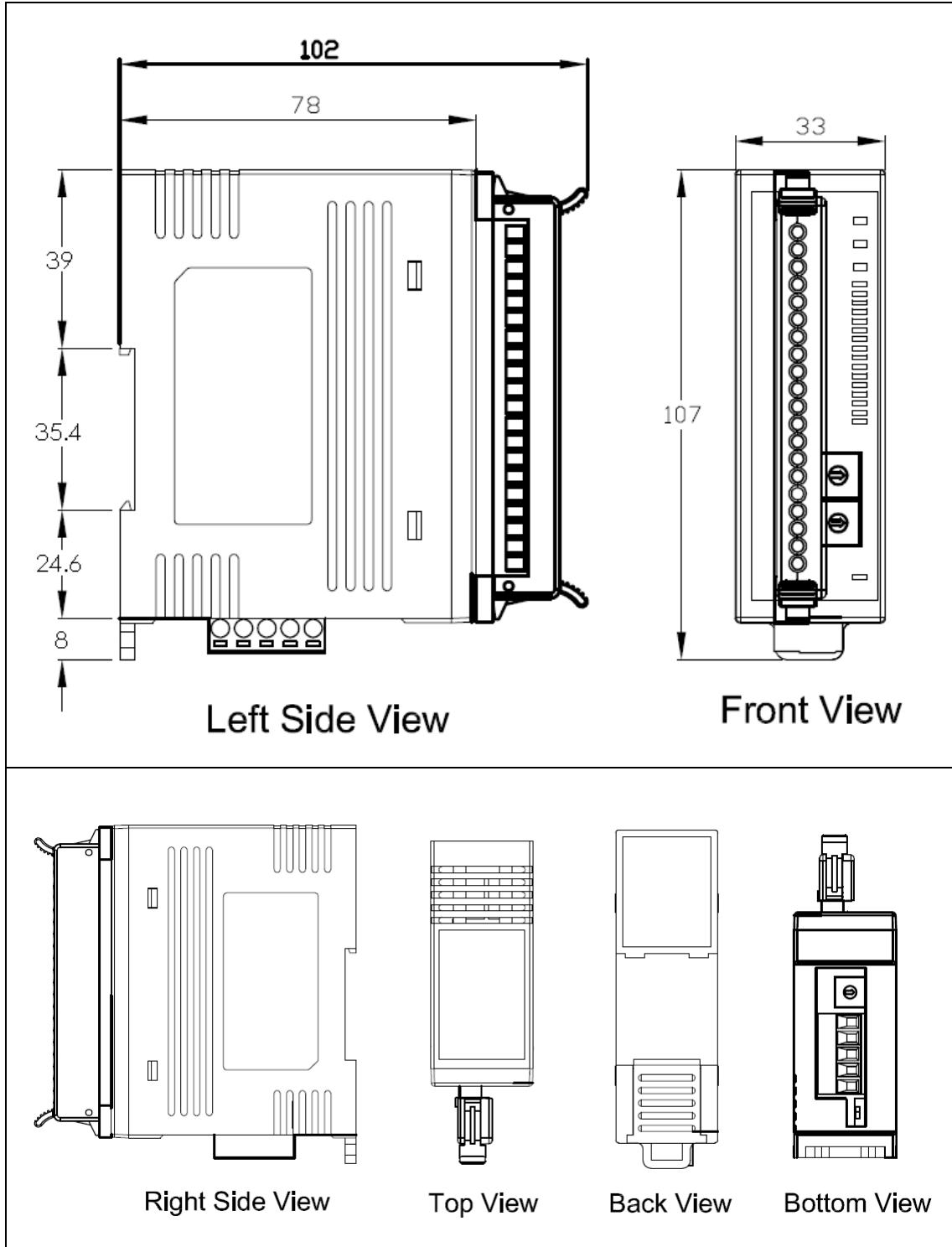

Unit: mm

Appendix B: Type Code Definition

Type Code Definition for CAN-2017D

Type Code	Input Range	Data Format	Min Value	Max Value
08h	-10 to +10V	Engineer Unit	-10V	+10V
		2's Complement HEX	8000h	7FFFh
09h	-5 to +5V	Engineer Unit	-5V	+5V
		2's Complement HEX	8000h	7FFFh
0Ah	-1 to +1V	Engineer Unit	-1V	+1V
		2's Complement HEX	8000h	7FFFh
0Bh	-500 to +500 mV	Engineer Unit	-500mV	+500mV
		2's Complement HEX	8000h	7FFFh
0Ch	-150 to +150 mV	Engineer Unit	-150mV	+150mV
		2's Complement HEX	8000h	7FFFh
0Dh	-20 to +20 mA (with 125Ω resistor)	Engineer Unit	-20mA	+20mA
		2's Complement HEX	8000h	7FFFh