



XP-8000 Series User Manual (for WES 2009/7 Based XPAC)

V1.0.0, October 2016



XP-8x31-WES7/XP-8x41/XP-8x41-Atom

Written by Sean Hsu

Edited by Anna Huang

Warranty

All products manufactured by ICP DAS are under warranty regarding defective materials for a period of one year, beginning from the date of delivery to the original purchaser.

Warning

ICP DAS assumes no liability for any damage resulting from the use of this product. ICP DAS reserves the right to change this manual at any time without notice. The information furnished by ICP DAS is believed to be accurate and reliable. However, no responsibility is assumed by ICP DAS for its use, not for any infringements of patents or other rights of third parties resulting from its use.

Copyright

Copyright © 2016 by ICP DAS Co., Ltd. All rights are reserved.

Trademark

The names used for identification only may be registered trademarks of their respective companies.

Contact US

If you have any problem, please feel free to contact us.

You can count on us for quick response.

Email: service@icpdas.com

Contents

1. INTRODUCTION	6
1.1. Features.....	7
1.2. Specifications	9
1.2.1. XP-8x31-WES7	9
1.2.2. XP-8x41.....	11
1.2.3. XP-8x41-Atom.....	13
1.3. Overview	15
1.4. Dimensions.....	23
1.5. Companion CD.....	26
2. GETTING STARTED	27
2.1. Mounting the XP-8000	28
2.2. Deploying a Basic XP-8000 System.....	31
2.3. Inserting the I/O Modules.....	33
2.4. Committing EWF to Allow Settings to Be Saved.....	35
2.5. Changing the User Interface Language	38
2.6. Using DCON Utility Pro Configure I/O Modules	41
3. SECURITY AND RISK	44
3.1. Administrator and User Accounts	45
3.1.1. Creating and Managing User Accounts in WES 7	46
3.1.2. Creating and Managing User Accounts in WES 2009	50
3.2. Windows Firewall.....	53
3.2.1. Enabling and disabling firewall in WES 7	54
3.2.2. Enabling and disabling firewall in WES 2009.....	56
3.3. IIS.....	58
3.3.1. Starting IIS Manager in WES 7	59
3.3.2. Creating a new FTP site in WES 7	60
3.3.3. Starting IIS Manager in WES 2009	64
3.3.4. Creating a new FTP site in WES 2009	65
3.4. EWF Manager.....	66
3.4.1. Disabling the EWF.....	67
3.4.2. Enabling the EWF.....	69
3.4.3. Using the EWF Manager commands	71
4. TOOLS AND TASKS	72
4.1. PAC Utility.....	73
4.1.1. System Information	73

4.1.2.	Auto Execution	74
4.1.3.	EWF Operation	75
4.1.4.	Multi-serial Port Module	76
4.1.5.	Language Setting	77
4.2.	DCON Utility Pro.....	78
5.	YOUR FIRST XP-8000 PROGRAM.....	79
5.1.	First XP-8000 Program in VB.NET	80
5.1.1.	Create a new project	81
5.1.2.	Specify the path of the PAC reference.....	83
5.1.3.	Add the control to the form	85
5.1.4.	Add the event handling for the control.....	87
5.1.5.	Upload the application to XP-8000.....	88
5.1.6.	Execute the application on XP-8000.....	90
5.2.	First XP-8000 Program in Visual C#	91
5.2.1.	Create a new project	92
5.2.2.	Specify the path of the PAC reference.....	94
5.2.3.	Add the control to the form	96
5.2.4.	Add the event handling for the control.....	98
5.2.5.	Upload the application to XP-8000.....	99
5.2.6.	Execute the application on XP-8000.....	101
5.3.	First XP-8000 Program in Visual C++	102
5.3.1.	Create a new project	103
5.3.2.	Specify the path of the PAC reference.....	106
5.3.3.	Add the control to the form	112
5.3.4.	Add the event handling for the control.....	114
5.3.5.	Upload the application to XP-8000.....	116
5.3.6.	Execute the application on XP-8000.....	117
6.	I/O EXPANSION MODULES AND SDKS SELECTION	118
7.	APIS AND DEMO REFERENCES.....	122
7.1.	PAC Standard APIs for System Operation	123
7.1.1.	VB.NET Demos for PAC Standard APIs.....	124
7.1.2.	C# Demos for PAC Standard APIs.....	125
7.1.3.	Visual C++ Demos for PAC Standard APIs	126
7.2.	PAC Standard APIs for PAC Expansion I/O	127
7.2.1.	VB.NET Demos for PAC Expansion I/O.....	128
7.2.2.	C# Demos for PAC Expansion I/O.....	130
7.2.3.	Visual C++ Demos for PAC Expansion I/O	132
8.	RECOVERY AND RESTORE.....	134

8.1.	XP-8000 Recovery.....	135
8.1.1.	Recovering the XP-8x31-WES7	135
8.1.2.	Recovering the XP-8x41-Atom.....	139
8.1.3.	Recovering the XP-8x41.....	143
8.2.	Restoring the Rescue CF Card.....	147
9.	XP-8000 UPDATES.....	151
9.1.	Updating the XP-8000 OS.....	152
9.2.	Updating the XP-8000 SDK.....	153
9.3.	Updating the PAC Utility.....	156
10.	XP-8000 DOWNLOAD CENTER	157
APPENDIX		158
A.	I-8K Modules and I-87K Modules	159
B.	Revision History	160

1. Introduction

This chapter provides an overview of the XP-8000 series and its components, and introduces the fundamental concepts for user familiar with the XP-8000.

XP-8000 series PACs, the new generation Windows Embedded Standard 2009/7 based XPACs, consists of the following models:

- XP-8x31-WES7: XP-8131-WES7, XP-8331-WES7, and XP-8731-WES7
- XP-8x41-Atom: XP-8141-Atom, XP-8341-Atom, and XP-8741-Atom
- XP-8x41: XP-8041, XP-8341, and XP-8741



Windows Embedded Standard 2009/7



XP-8000 Series is the new generation Windows Embedded Standard based PACs of ICP DAS. It is equipped with with a variety of CPU options (AMD LX800, 500 MHz/Intel Atom Z510, 1.1 GHz/R3600), various connectivity (VGA, USB, Ethernet, RS-232/485) and 0/1/3/7 I/O slot(s) for high performance parallel I/O modules (high profile I-8K Series) and serial I/O modules (high profile I-87K series). The benefits of running Windows Embedded Standard on XPAC include hard real-time capability, small core size, fast boot speed, interrupt handling at a deeper level and achievable deterministic control. XPAC is also capable of running PC-based control software such as Visual Basic .NET, Visual C#,.... etc. It has all of the best features of both traditional PLCs and Windows capable PCs.

1.1. Features

The XP-8000 offers the most comprehensive configuration to meet specific application requirements. The following list shows the hardware and software features designed to simplify installation, configuration and application.

Hardware Features

- Powerful CPU module:

XP-8x31-WES7	XP-8x41	XP-8x41-Atom
x86 CPU, 1 GHz, dual-core	AMD LX800 CPU, 32-bit and 500 MHz	Intel Atom Z510 CPU, 1.33 GHz

- Rich Memories:

	XP-8x31-WES7	XP-8x41	XP-8x41-Atom
System Memory	2GB DDR3	1 GB DDR	1 GB DDR2
Built-in Flash Disk	32 GB	4 GB	16 GB
EEPROM	16 KB		
Dual Battery Backup SRAM	512 KB		
CF card	one CF card (support up to 32 GB)		

- VGA Port x 1, USB 2.0 port x 2/4, Series port (RS-232/RS-485) x 4/5
- 64-bit Hardware Serial Number
- Dual Watchdog Timers
- Dual Ethernet Ports (10 M/100 M/1000 M)
- Redundant Power Input
- Operating Temperature: -25 to +75 °C

Software Features

- Windows Embedded Standard 2009/7
- Internet Information Services, FTP server and web server
- ASP.NET
- SQL Server 2005/2008 Express Edition
- .NET Framework 3.5/4.5
- Remote Desktop Connection
- Built-in OPC Server
- Rich Software Solutions -
SDK for Microsoft Visual Studio.NET 2005/2008 and Visual Studio 6.0 Borland
C++ Builder and Delphi

1.2. Specifications

The table below summarizes the specifications of the XP-8000.

1.2.1. XP-8x31-WES7

Models	XP-8131-WES7	XP-8331-WES7	XP-8731-WES7
OS	Windows Embedded Standard 7		
.Net Framework	4.5		
Embedded Service	FTP Server, Internet Information Service 5.1, ASP (Java Script, VB Script), SQL Server 2008 Express		
SDK Provided	DII for VC, VB, Delphi, BCB, Visual Studio .NET 2005/2008		
Multilanguage Support	English, German, French, Spanish, Russian, Italian, Czech, Japanese, Korean, Simplified Chinese, Traditional Chinese		
CPU Module			
CPU	x86 CPU, 1 GHz, dual-core		
SDRAM	2 GB DDR3		
Dual Battery Backup SRAM	512 KB; data valid up to 5 years		
Flash	32 GB		
EEPROM	16 KB; Data Retention: 40 years; 1,000,000 erase/write cycles		
CF Card	CF slot with one CF card (support up to 32 GB)		
RTC (Real Time Clock)	Provide second, minute, hour, date, day of week, month, year		
64-bit Hardware Serial Number	Yes, for software copy protection		
Dual Watchdog Timers	Yes (0.8 second)		
Rotary Switch	Yes (0 to 9)		
DIP Switch	Yes (8 bits)		
Programmable LED Indicator	2 (L1 and L2)		
VGA & Communication Ports			
VGA Resolution	1600 x 1200, 1024 x 768, 800 x 600, 640 x 480		
Dual Ethernet Port	RJ-45 x 2, 10/100/1000 Base-T (Auto-negotiating, Auto MDI/MDI-X, LED indicators)		

USB 2.0	4		
COM 1	Internal communication with high profile I-87K series modules in slots		
COM 2	RS-232 (RxD, TxD and GND); non-isolated		
COM 3	RS-485 (Data+, Data-) with internal self-tuner ASIC; 3000 V _{DC} isolated		
COM 4	RS-232/RS-485 (RxD, TxD, CTS, RTS and GND for RS-232, Data+ and Data- for RS-485); non-isolated		
COM 5	RS-232 (RxD, TxD, CTS, RTS, DSR, DTR, CD, RI and GND); non-isolated		
Audio	Microphone-in and Earphone-out		
I/O Expansion Slots			
Number of I/O slots	1	3	7
Supported I/O modules	I-8K and I-87K series I/O Modules		
Mechanical			
Dimensions (W x L x H), unit: mm	169 x 132 x 125	231 x 132 x 125	355 x 132 x 125
Installation	DIN-Rail or Wall Mounting		
Environmental			
Operating Temperature	-25 °C to +75 °C		
Storage Temperature	-30 °C to + 80 °C		
Ambient Relative Humidity	10 % to 90 % RH (non-condensing)		
Power			
Input Range	+10 V _{DC} to +30 V _{DC}		
Redundant Power Inputs	Yes, with one power relay (1 A @ 24 V _{DC}) for alarm		
Isolation	1 kV		
Capacity	25 W	35 W	
Consumption	16.6 W	16.8 W	18 W

1.2.2. XP-8x41

Models	XP-8041	XP-8341	XP-8741
OS	Windows Embedded Standard 2009		
.Net Compact Framework	3.5		
Embedded Service	FTP Server, Internet Information Service 5.1, ASP (Java Script, VB Script), SQL Server 2005 Express		
SDK Provided	DII for VC, VB, Delphi, BCB, Visual Studio .NET 2005/2008		
Multilanguage Support	English, German, French, Spanish, Russian, Italian, Czech, Japanese, Korean, Simplified Chinese, Traditional Chinese		
CPU Module			
CPU	AMD LX800 CPU, 32-bit and 500 MHz		
SDRAM	1 GB DDR		
Dual Battery Backup SRAM	512 KB; data valid up to 5 years		
Flash	4 GB		
EEPROM	16 KB		
CF Card	CF slot with one CF card (support up to 32 GB)		
RTC (Real Time Clock)	Provide second, minute, hour, date, day of week, month, year		
64-bit Hardware Serial Number	Yes, for software copy protection		
Dual Watchdog Timers	Yes (0.8 second)		
Programmable LED Indicator	2 (L1 and L2)		
Rotary Switch	Yes (0 to 9)		
DIP Switch	-	Yes (8 bits)	
VGA & Communication Ports			
VGA Resolution	1600 x 1200, 1024 x 768, 800 x 600, 640 x 480		
Dual Ethernet Port	RJ-45 x 2, 10/100 Base-T (Auto-negotiating, Auto MDI/MDI-X, LED indicators)		
USB 2.0	2		
COM 1	RS-232 (Rx, Tx and GND); non-isolated	Internal communication with the high profile I-87K series modules in slots	
COM 2	RS-232 (Rx, Tx and GND); non-isolated		
COM 3	RS-485 (Data+, Data-) with internal self-tuner ASIC; 3000 V _{DC} isolated		

COM 4	RS-232/RS-485 (RxD, TxD, CTS, RTS and GND for RS-232, Data+ and Data- for RS-485); non-isolated		
COM 5	RS-232 (RxD, TxD, CTS, RTS, DSR, DTR, CD, RI and GND); non-isolated		
I/O Expansion Slots			
Number of I/O slots	0	3	7
Supported I/O modules	I-8K and I-87K series I/O Modules		
Mechanical			
Dimensions (W x L x H), unit: mm	137 x 132 x 125	231 x 132 x 125	355 x 132 x 125
Installation	DIN-Rail or Wall Mounting		
Environmental			
Operating Temperature	-25 °C to +75 °C		
Storage Temperature	-30 °C to + 80 °C		
Ambient Relative Humidity	10 % to 90 % RH (non-condensing)		
Power			
Input Range	+10 V _{DC} to +30 V _{DC}		
Redundant Power Inputs	Yes, with one power relay (1 A @ 24 V _{DC}) for alarm		
Isolation	1 kV		
Capacity	1.8 A, 5 V supply to CPU and backplane, 15 W in total	1.8 A, 5 V supply to CPU and backplane, 5.2 A, 5 V supply to I/O expansion slots, 35 W in total	2.0 A, 5 V supply to CPU and backplane, 5.0 A, 5 V supply to I/O expansion slots, 35 W in total
Consumption	14.4 W (0.6 A @ 24 V _{DC})		16.8 W (0.7 A @ 24 V _{DC})

1.2.3. XP-8x41-Atom

Models	XP-8141-Atom	XP-8341-Atom	XP-8741-Atom
OS	Windows Embedded Standard 2009		
.Net Compact Framework	3.5		
Embedded Service	FTP Server, Internet Information Service 5.1, ASP (Java Script, VB Script), SQL Server 2005 Express		
SDK Provided	DII for VC, VB, Delphi, BCB, Visual Studio .NET 2005/2008		
Multilanguage Support	English, German, French, Spanish, Russian, Italian, Czech, Japanese, Korean, Simplified Chinese, Traditional Chinese		
CPU Module			
CPU	Intel Atom Z510 CPU, 1.33 GHz		
SDRAM	1 GB DDR2		
Dual Battery Backup SRAM	512 KB; data valid up to 5 years		
Flash	16 GB		
EEPROM	16 KB		
CF Card	CF slot with one CF card (support up to 32 GB)		
RTC (Real Time Clock)	Provide second, minute, hour, date, day of week, month, year		
64-bit Hardware Serial Number	Yes, for software copy protection		
Dual Watchdog Timers	Yes (0.8 second)		
Rotary Switch	Yes (0 to 9)		
DIP Switch	Yes (8 bits)		
Programmable LED Indicator	2 (L1 and L2)		
VGA & Communication Ports			
VGA Resolution	1600 x 1200, 1024 x 768, 800 x 600, 640 x 480		
Dual Ethernet Port	RJ-45 x 2, 10/100/1000 Base-T (Auto-negotiating, Auto MDI/MDI-X, LED indicators)		
USB 2.0	4		
COM 1	Internal communication with high profile I-87K series modules in slots		
COM 2	RS-232 (RxD, TxD and GND); non-isolated		
COM 3	RS-485 (Data+, Data-) with internal self-tuner ASIC; 3000 V _{DC} isolated		

COM 4	RS-232/RS-485 (RxD, TxD, CTS, RTS and GND for RS-232, Data+ and Data- for RS-485); non-isolated		
COM 5	RS-232 (RxD, TxD, CTS, RTS, DSR, DTR, CD, RI and GND); non-isolated		
Audio	Microphone-in and Earphone-out		
I/O Expansion Slots			
Number of I/O slots	1	3	7
Supported I/O modules	I-8K and I-87K series I/O Modules		
Mechanical			
Dimensions (W x L x H), unit: mm	169 x 132 x 125	231 x 132 x 125	355 x 132 x 125
Installation	DIN-Rail or Wall Mounting		
Environmental			
Operating Temperature	-25 °C to +75 °C		
Storage Temperature	-30 °C to + 80 °C		
Ambient Relative Humidity	10 % to 90 % RH (non-condensing)		
Power			
Input Range	+10 V _{DC} to +30 V _{DC}		
Redundant Power Inputs	Yes, with one power relay (1 A @ 24 V _{DC}) for alarm		
Isolation	1 kV		
Capacity	3.7 A, 5 V supply to CPU and backplane, 1.3 A, 5 V supply to I/O expansion slots, 25 W in total	3.8 A, 5 V supply to CPU and backplane, 3.2 A, 5 V supply to I/O expansion slots, 30 W in total	4.0 A, 5 V supply to CPU and backplane, 3.0 A, 5 V supply to I/O expansion slots, 35 W in total
Consumption	16.6 W (0.69 A @ 24 V _{DC})	16.8 W (0.7 A @ 24 V _{DC})	18 W (0.75 A @ 24 V _{DC})

1.3. Overview

The XP-8000 is equipped with several interfaces and peripherals that can be integrated with external systems. Here is an overview of the components and its descriptions.

XP-8041

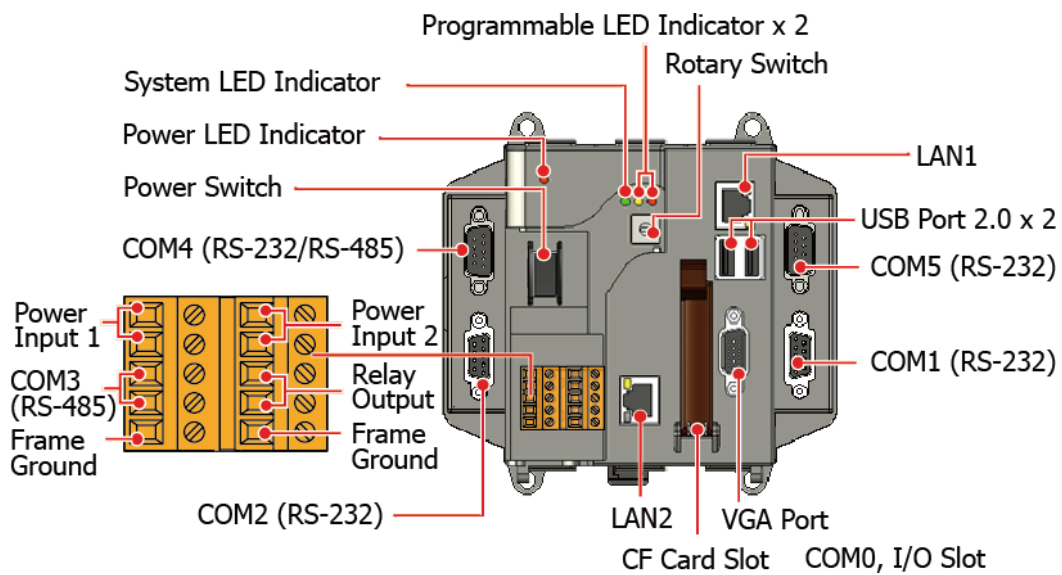

XP-8131-WES7/XP-8141-Atom

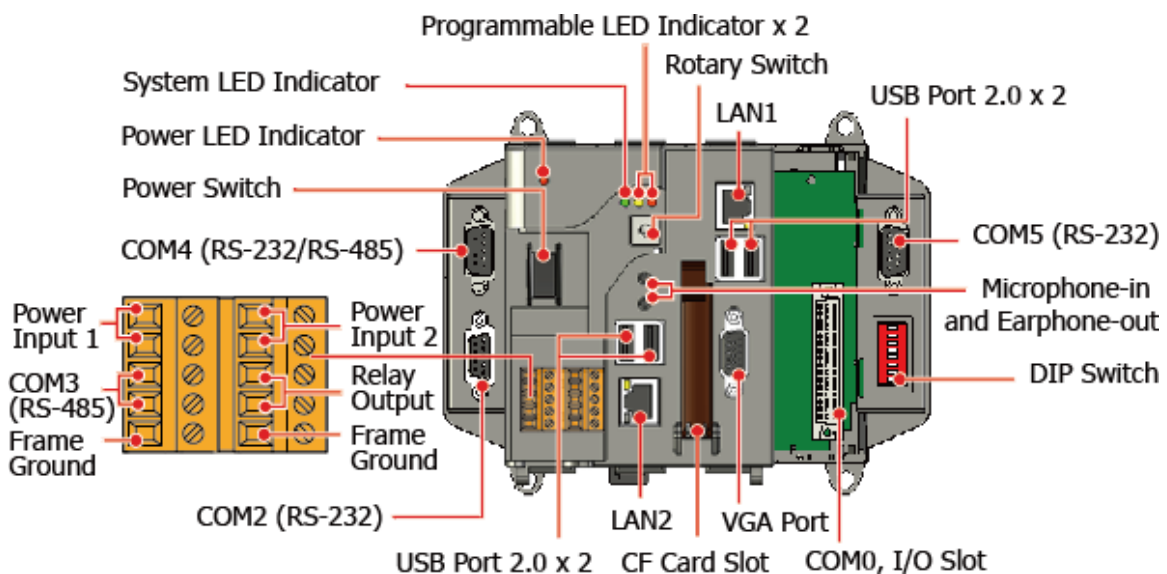

XP-8331-WES7/ XP-8341/XP-8341-Atom

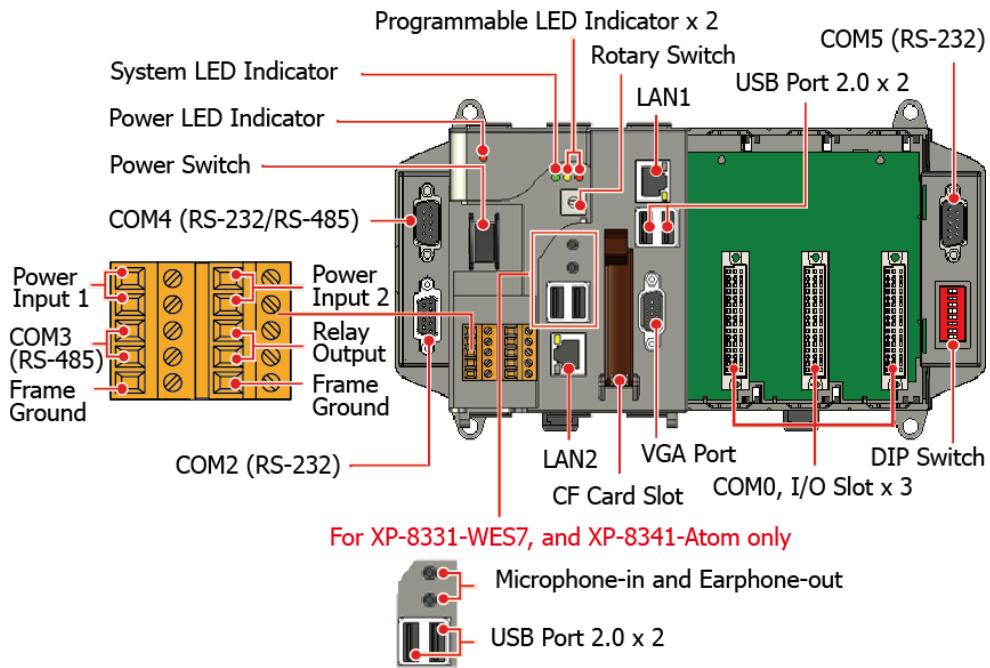

XP-8731-WES7/ XP-8741/XP-8741-Atom

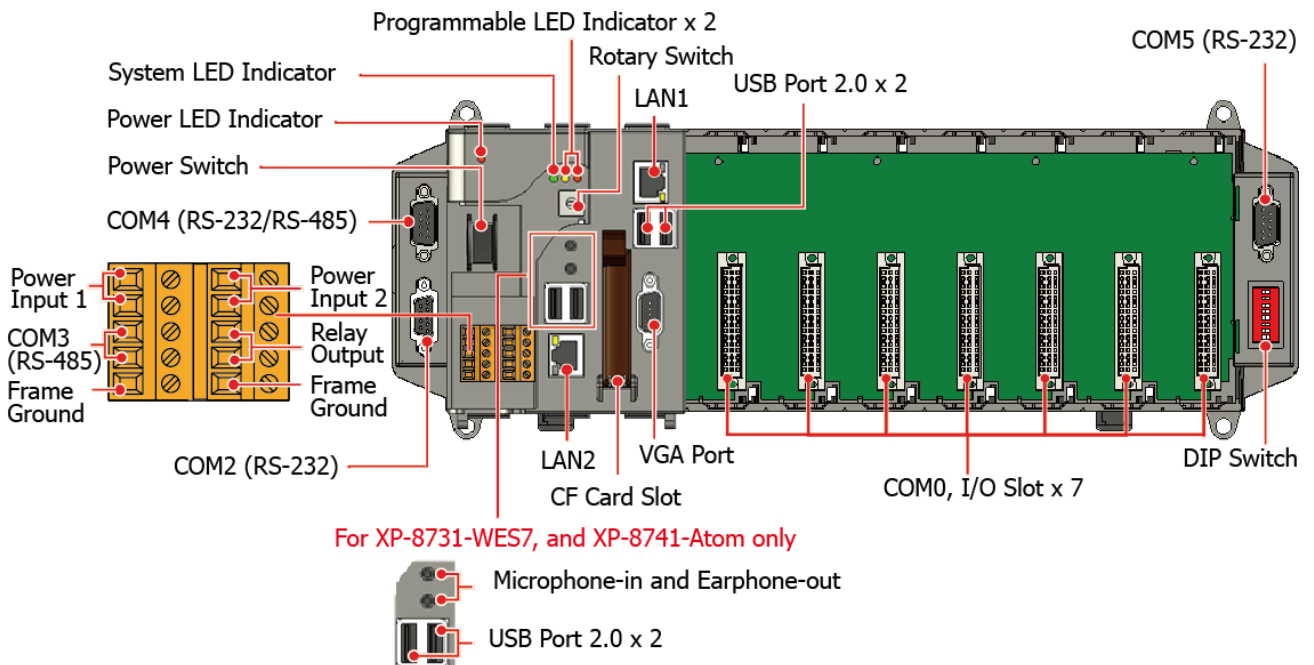

The details of these items are as follows:

LED Indicators

The XP-8000 has 4 LED indicators. The first is labeled PWR, located near the power switch and shows the power status. The three other are located next the rotary switch, the left one is labeled RUN and shows the operation status, the two other are denoted L1 and L2 and used for user defined.

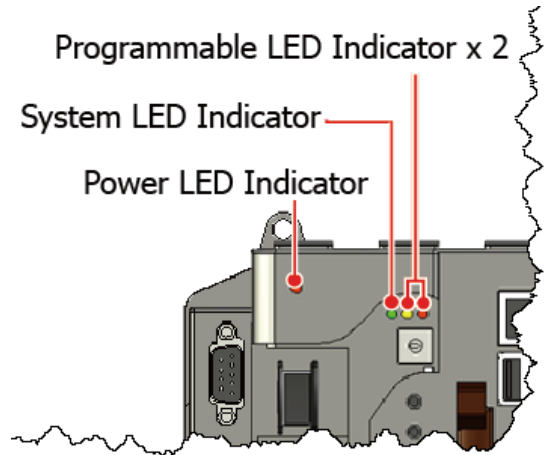

LED Indicator	Label	State (Color)	Meaning
Programmable LED Indicators	L1 and L2	-	Programmable LED indicators
System LED indicator	RUN	Orange	OS is running
Power LED Indicator	PWR	Green	Power 1 is on

Operating mode Selector

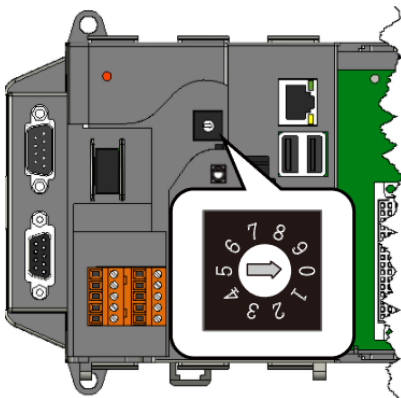

Rotary Switch is an operating mode selector that provides functions to configure with the selection of operating mode and authorization control.

Power Switch

The power switch is a small switch that enables or disables power to electric circuits and loads in the XP-8000.

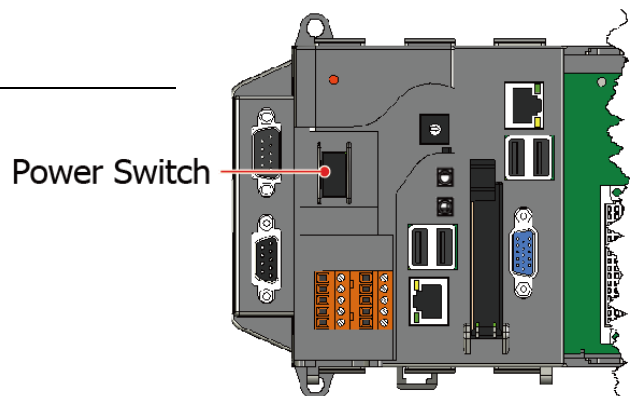

Redundant Power (PWR1 and PWR2) and relay output

The XP-8000 has a 2-row 10-wire terminal block; there has 4-wire for redundant power inputs and 2-wire for relay output. The details of the redundant power are shown to the side.

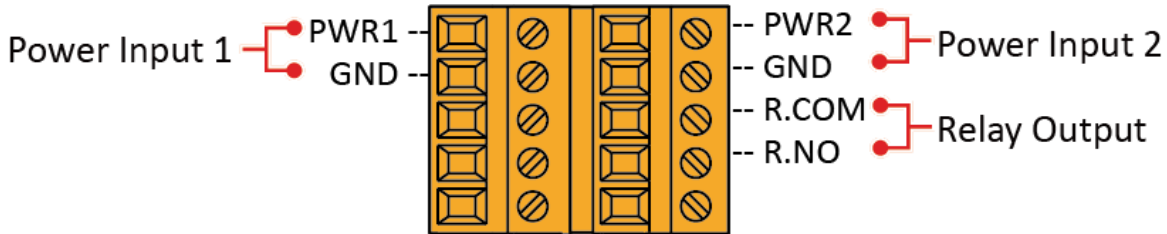

• Redundant Power

The XP-8000 provides redundant power that can keep the device running if a problem occurs in the power supply.

• Relay Output

The XP-8000 has a relay output that can be used to control a light, siren, or other low voltage device when an alarm occurs.

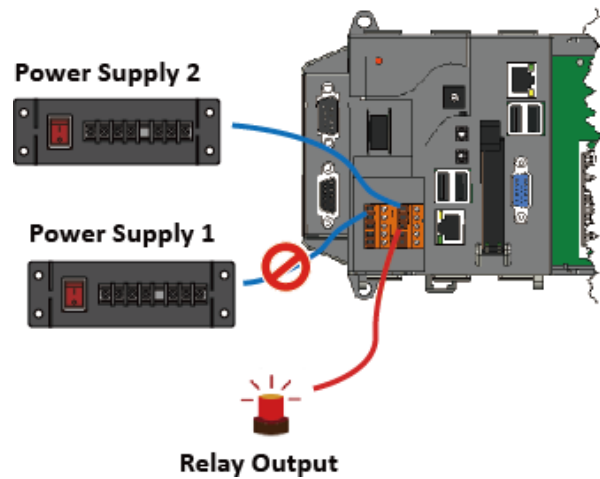

Communication Ports

The XP-8000 is equipped with several interfaces and peripherals that can be integrated with external systems.

• VGA Port

The VGA connector is a 3-row 15-pin connector that can be used to connect a monitor at a variety of supported VGA resolutions. and the output resolution covers, 1600 x 1200, 1024 x 768, 800 x 600, 640 x 480.

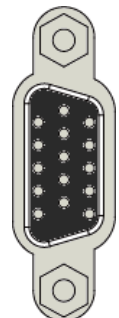

- **CF slot**

The CF slot comes with a free CF card that can be used to restore the system, and expand the memory up to 32 GB.

- **Ethernet Ports (LAN1 and LAN2)**

The XP-8000 has 2 Ethernet ports that can be used to connect the router to the Internet or to other devices.

Each Ethernet port has 2 LED indicators, which are used to indicate the network speed and Link/Acting, as described below.

LED Indicator	State (Color)	Meaning
10/100M	ON (Yellow)	Network Speed: 100 MB GB
	OFF	Network Speed: 10 MB
1G	ON (Yellow)	Network Speed: 1000 MB GB
	OFF	Network Speed: 10/100 MB
Link/Act	ON (Green)	The Link is active
	OFF	The Link is inactive
	Blinking(Green)	Network activity

For XP-8x41:



For XP-8x31-WES7, and XP-8x41-Atom:

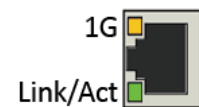

- **USB Ports (P1, P2, P3 and P4)**

(P3 and P4 are for XP-8x31-WES7 and XP-8x41-Atom only)

The XP-8000 has 2/4 USB 2.0 ports that can be used to connect the USB devices such as mouse, keyboard or an external USB hard drive.

- **Microphone-in and Earphone-out (for XP-8x31-WES7 and XP-8x41-Atom only)**

The XP-8000 has a microphone-in and an earphone-out that can be used to process the input and the output of sound.

- **COM1, Expansion I/O Slot (Except XP-8041)**

The XP-8000 has 1/3/7 I/O slot(s) that can be used to integrate high performance parallel I/O modules (high profile I-8K Series) or serial I/O modules (high profile I-87K series).

- **COM1 (RS-232) (for XP-8041 only)**

The COM1 port is a 9-pins RS-232 connector. The details of the COM1 port specifications are shown to the side.

Note: 16C550 compatible

Port Type: Male

Baud Rate: 115200, 57600, 38400, 19200, 9600, 4800, 2400, 1200 bps

Data Bits: 5, 6, 7, 8

Parity: None, Even, Odd, Mark (Always 1), Space (Always 0)

Stop Bits: 1, 2

FIFO: 128 bytes

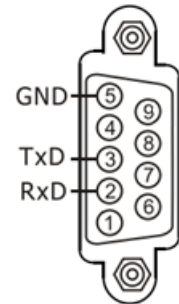

- **COM2 (RS-232)**

The COM2 port is a 9-pins RS-232 connector. The details of the COM2 port specifications are shown to the side.

Note: 16C550 compatible

Port Type: Female

Baud Rate: 115200, 57600, 38400, 19200, 9600, 4800, 2400, 1200 bps

Data Bits: 7, 8

Parity: None, Even, Odd

Stop Bits: 1

FIFO: 1 byte

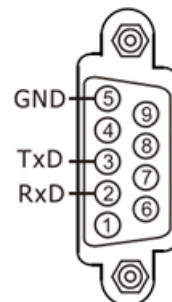

COM3 (2-wire RS-485)

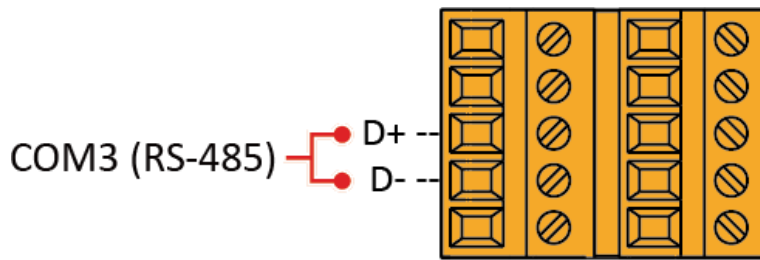

Note: 16C550 compatible

Port Type: Terminals

Baud Rate: 115200, 57600, 38400, 19200, 9600, 4800, 2400, 1200 bps

Data Bits: 5, 6, 7, 8

Parity: None, Even, Odd, Mark (Always 1), Space (Always 0)

Stop Bits: 1, 2

FIFO: 128 bytes

● COM4 (RS-232/RS-485)

The COM4 port is a 9-pins RS-232/RS-485 connector. The details of the COM4 port specifications are shown to the side.

Note: 16C550 compatible

Port Type: Male

Baud Rate: 115200, 57600, 38400, 19200, 9600, 4800, 2400, 1200 bps

Data Bits: 5, 6, 7, 8

Parity: None, Even, Odd, Mark (Always 1), Space (Always 0)

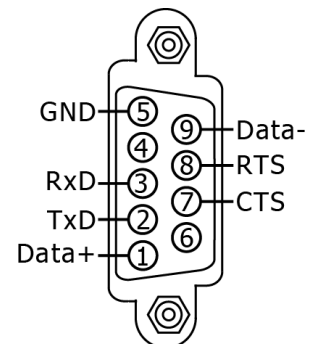

COM4 can be configured as either RS-232 or RS-485, that only can select one at a time and its configuration depends on the pin connections as follows:

- **RS-232** (RXD, TXD, CTS, RTS and GND)
- **RS-485** (Data+ and Data-)

There is no software configuration or hardware jumper needed.

- **COM5 (RS-232)**

The COM5 port is a 9-pins RS-232 connector. The details of the COM5 port specifications are shown to the side.

Note: 16C550 compatible

Port Type: Male

Baud Rate: 115200, 57600, 38400, 19200, 9600, 4800, 2400, 1200 bps

Data Bits: 5, 6, 7, 8

Parity: None, Even, Odd, Mark (Always 1), Space (Always 0)

Stop Bits: 1, 2

FIFO: 16 bytes

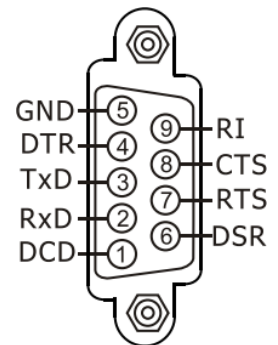

Tips & Warnings



The table below shows the data bit and their corresponding stop bit for COM2, COM3, COM4, and COM5

Word Length	Number of Stop Bits
5, 6, 7, 8	1
5	1.5
6, 7, 8	2

1.4. Dimensions

The diagrams below provide the dimensions of the XP-8000 to use in defining your enclosure specifications. Remember to leave room for potential expansion if you are using other components in your system.

The height dimension is the same for all XP-8000. The width depending on your choose of I/O expansion slots. All dimensions are in millimeters.

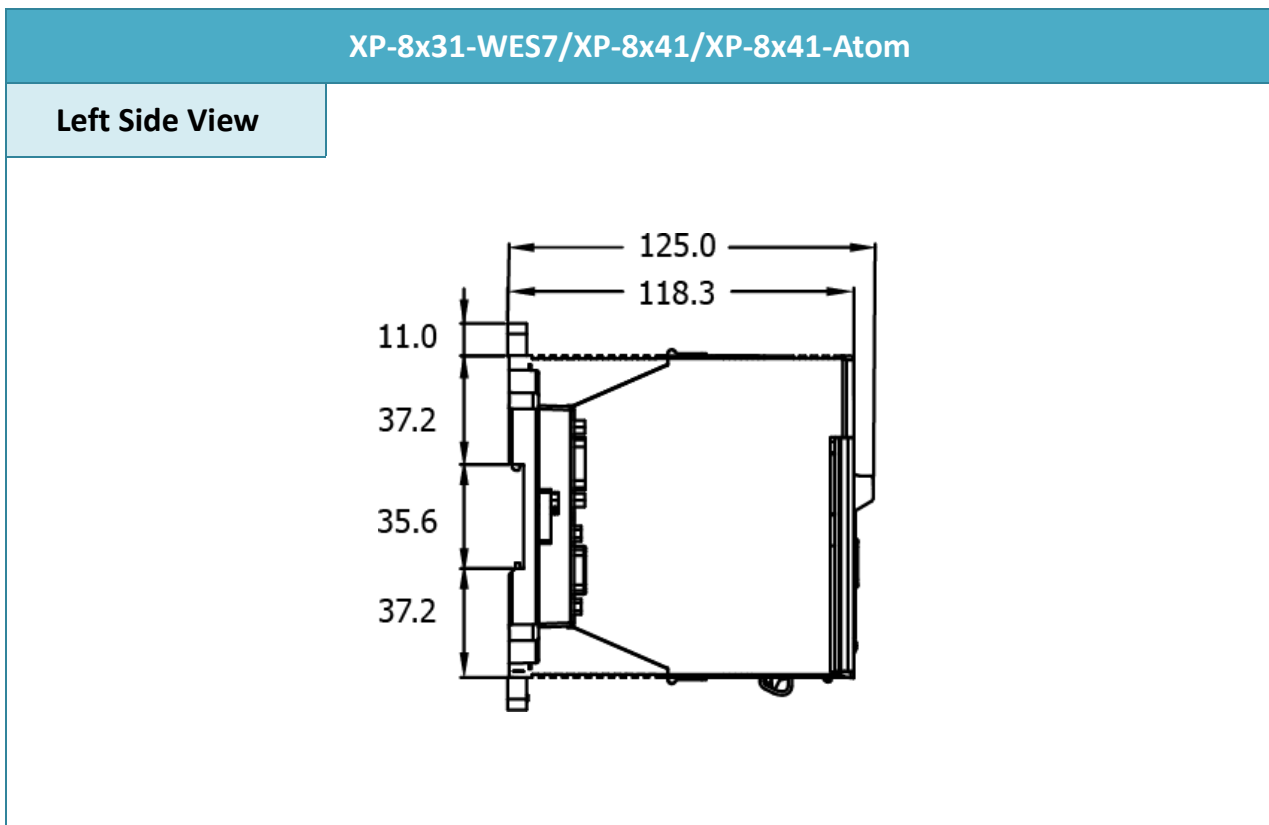

XP-8041

Front View

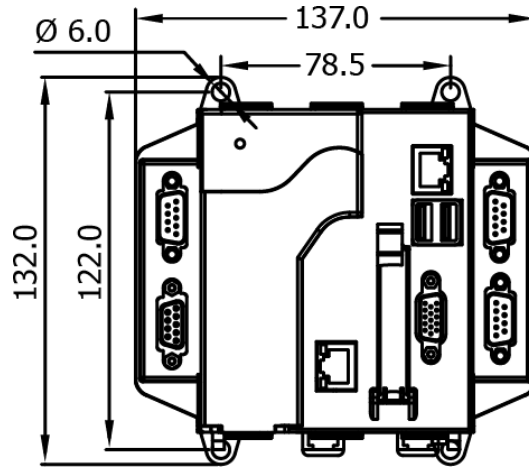

XP-8131-WES7 XP-8141-Atom

Front View

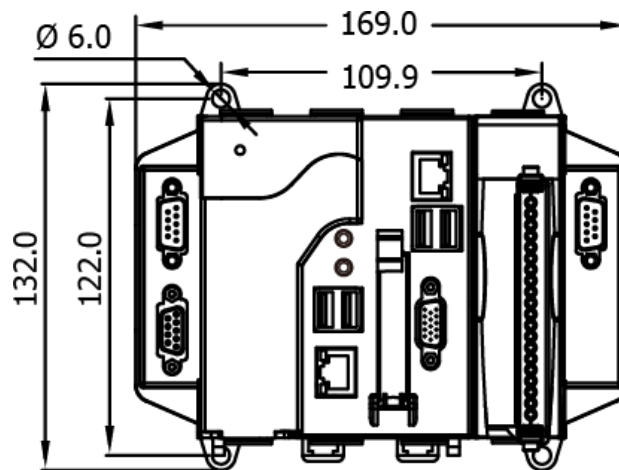

XP-8331-WES7/XP-8341/XP-8341-Atom

Front View

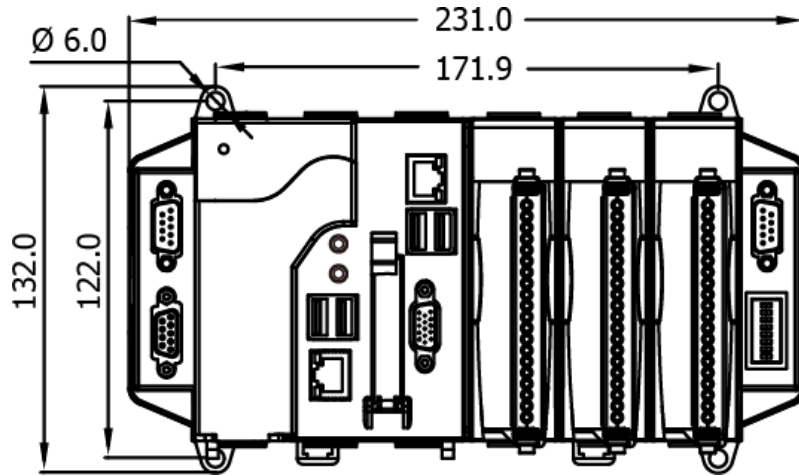

XP-8731-WES7/XP-8741/XP-8741-Atom

Front View

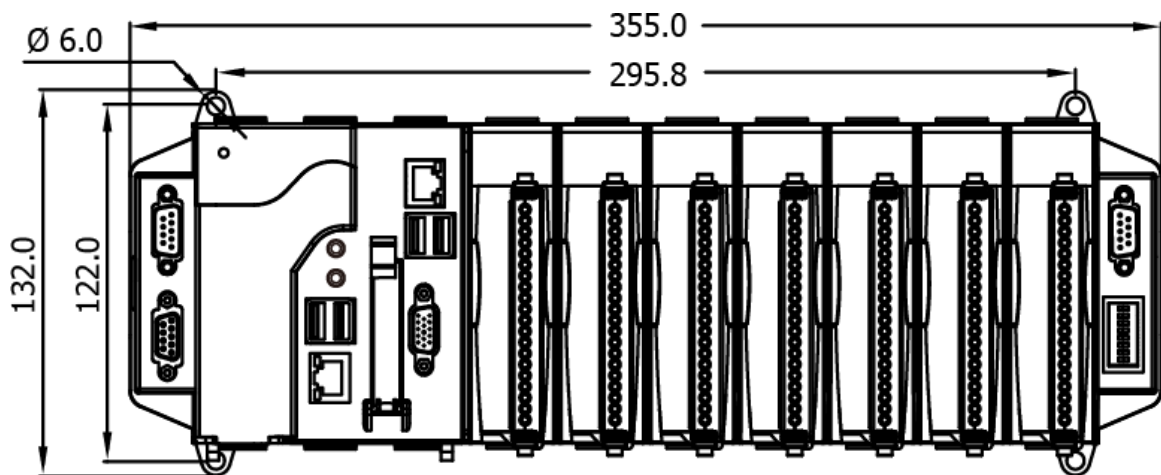

1.5. Companion CD

This package comes with a CD that provides a collection of the software utility, documentation, drivers, demo program and application.

- For XP-8x31-WES7:
CD:\ippc-wes7\
<ftp://ftp.icpdas.com/pub/cd/ippc-wes7/>
- For XP-8x41:
CD:\XP-8000\
<http://ftp.icpdas.com/pub/cd/xp-8000/>
- For XP-8x41-Atom:
CD:\XPAC-Atom\
<http://ftp.icpdas.com/pub/cd/xpac-atom/>

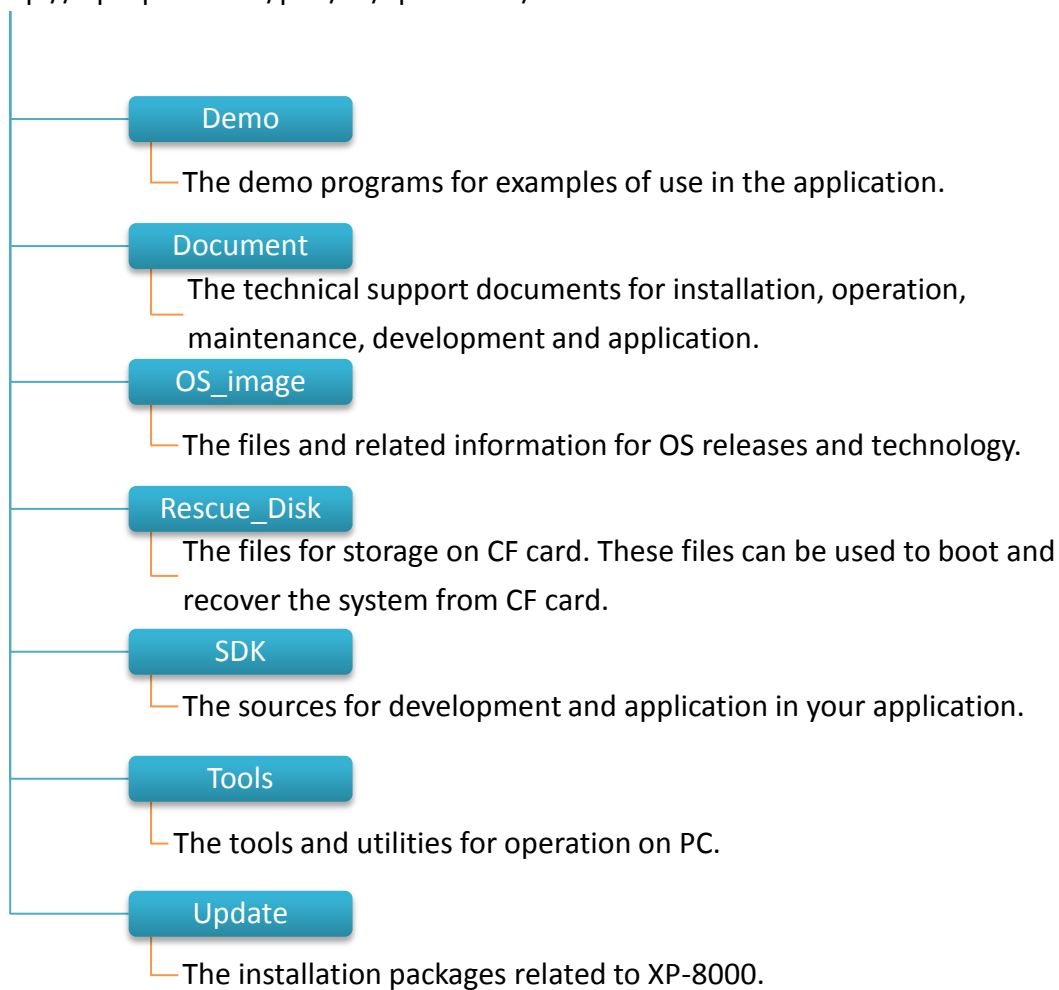

2. Getting Started

This chapter provides a guided tour of the XP-8000 installation and configuration that describes the steps needed to download, install, configure, and run the basic procedures for user working with the XP-8000 for the first time.

Before starting any task, please check the package contents. If any of the following package contents are missing or damaged, contact your dealer, distributor.



XP-8x31-WES7/XP-8x41/XP-8x41-Atom



CF Slot with one CF card

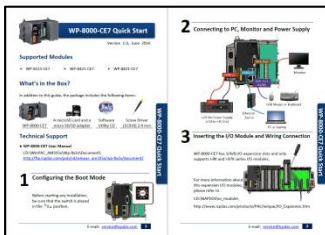

Quick Start Guide



Software Utility CD



Screw Driver 2.4 mm

2.1. Mounting the XP-8000

The XP-8000 can be mounted either directly to a wall/panel, or onto a standard 35mm DIN rail.

Wall/Panel mounting

Step 1: Install the four mounting screws into the 4 keyhole mounting holes

Step 2: Fasten the screws securely

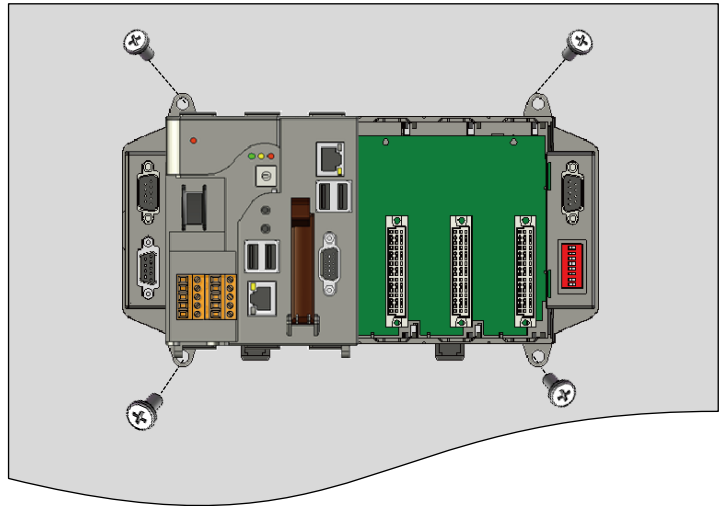

Tips & Warnings



There must be a minimum clearance of 50mm between the XP-8000 and the top and bottom side of the enclosure panel.

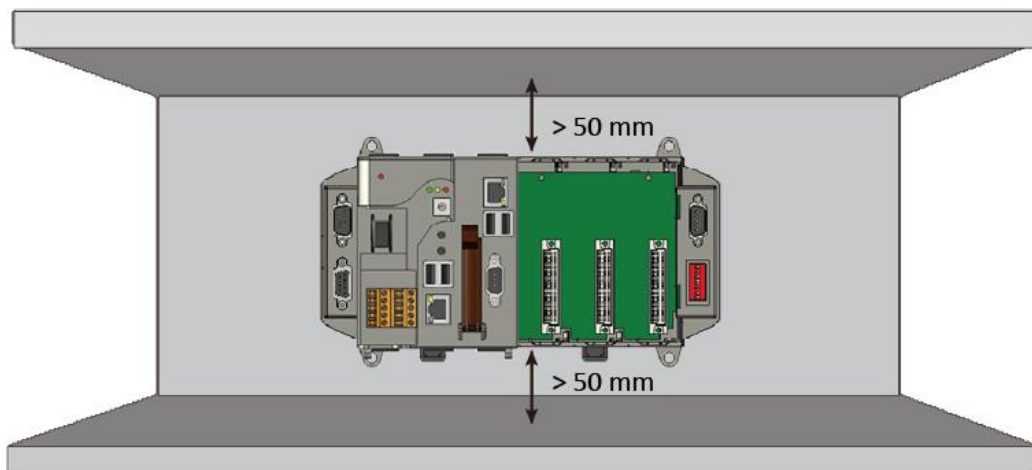

Step 1: Hook upper tab over upper flange of DIN rail

Step 2: Tilt the module toward DIN rail until it snaps securely to DIN rail

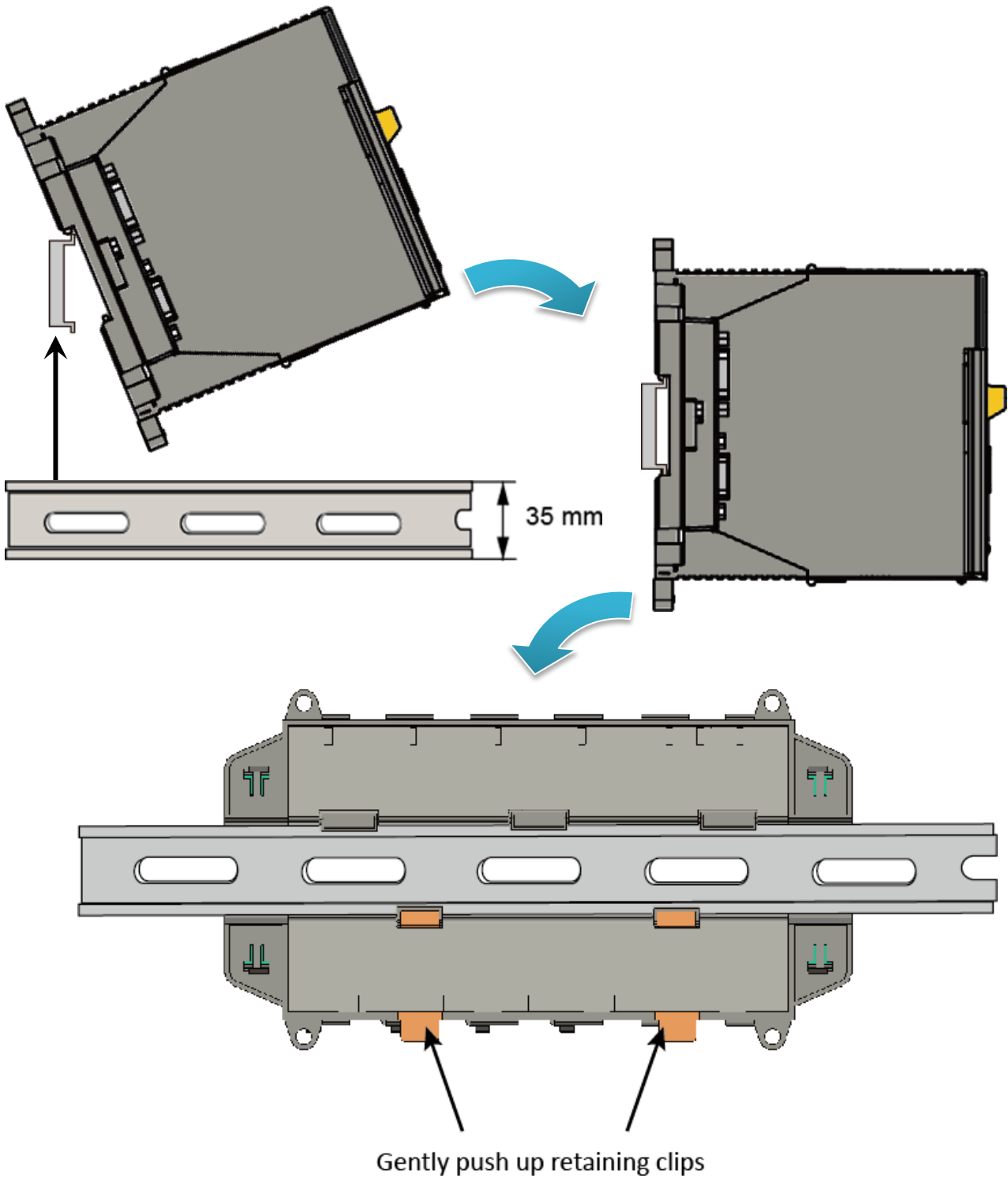

Tips & Warnings



A good common ground reference (earth ground) is essential for proper operation of the XP-8000. One side of all control circuits, power circuits and the ground lead must be properly connected to earth ground by either installing a ground rod in close proximity to the enclosure or by connecting to the incoming power system ground. There must be a single-point ground (i.e. copper bus bar) for all devices in the enclosure that require an earth ground.

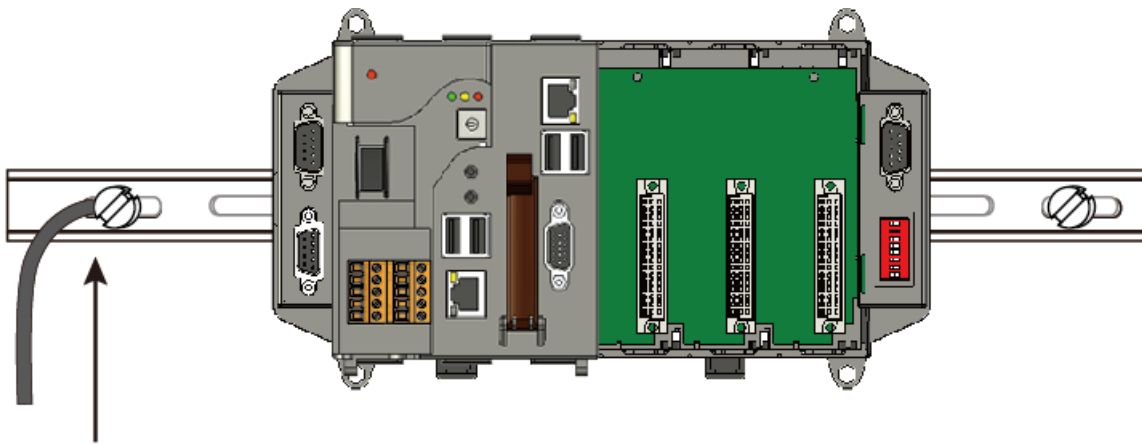

Connect the ground lead to the ground screw

2.2. Deploying a Basic XP-8000 System

The XP-8000 provides a variety of communication interface to suit a range of application. Here is a simple application for using the XP-8000.

Step 1: Connect the positive terminal (+) of the power supply to the terminal PWR1/2 and the negative terminal (-) of the power supply to the P.GND

Tips & Warnings



1. The input range of power supply is +10 to +30 V_{DC}.
2. The XP-8000 have two power inputs that can be connected simultaneously to the two independent power sources. If one power source fails, the other source takes over automatically. Redundant power inputs help assure non-stop operation of the XP-8000.

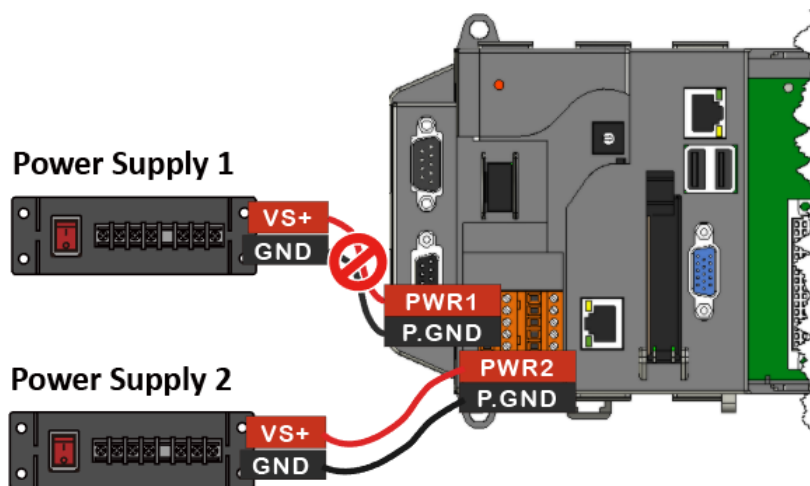

Step 2: Connect the USB mouse or the USB keyboard to the USB port

Step 3: Connect the monitor to the VGA port

Step 4: Connect to PC or the laptop to the LAN port via an Ethernet switch

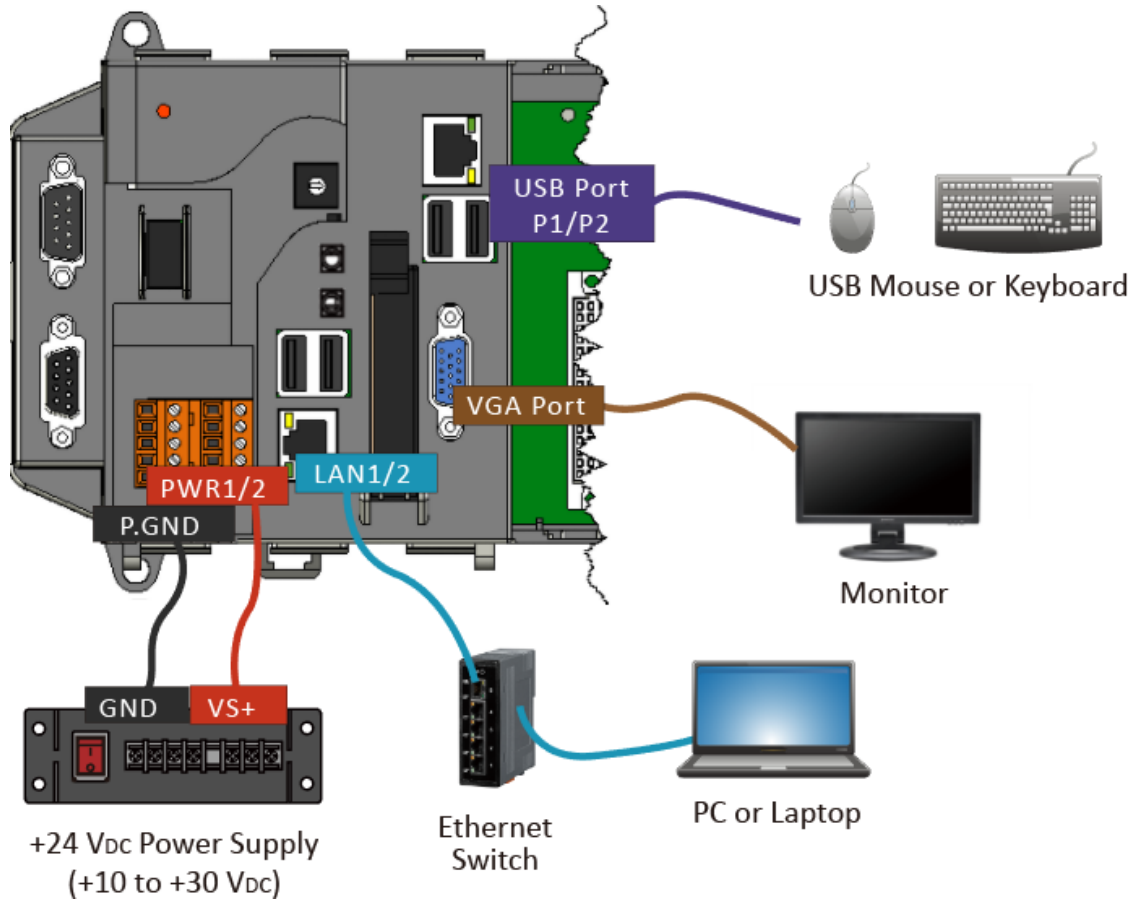

2.3. Inserting the I/O Modules

XP-8000 has 0/1/3/7 I/O expansion slot(s) and only supports I-8K and I-87K series I/O modules.

Before choosing the right I/O modules, you first need to know the I/O expansion capacities in order to choose the best expansion module for achieving maximal efficiency.

For more information about the I/O expansion modules that are compatible with the XP-8000, please refer to:

http://www.icpdas.com/root/product/solutions/remote_io/rs-485/i-8k_i-87k/i-8k_i-87k_selection.html

Step 1: Align circuit card with slot and press firmly to seat module into connector

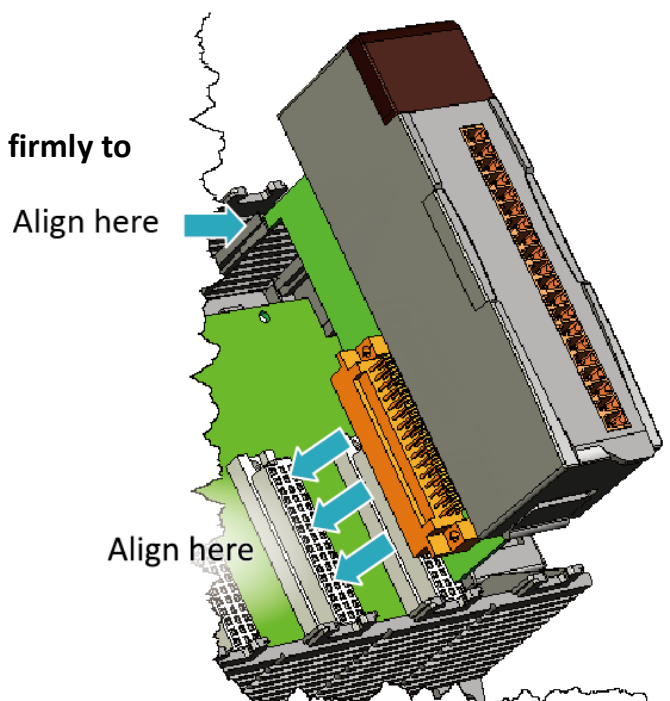

Tips & Warnings



It is recommended that the power to the XP-8000 is switched off when wiring the I/O module which are plugging in the XP-8000 slots.

Step 2: Pull top and bottom locking tabs toward module face. Click indicates lock is engaged

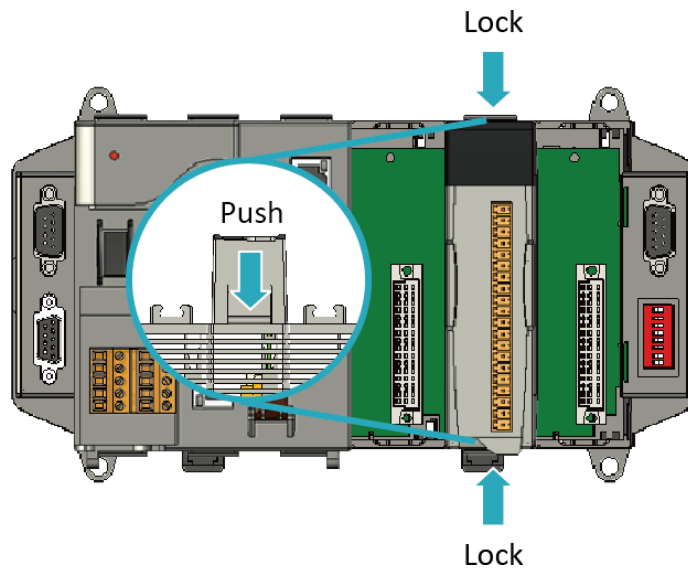

Step 3: Attach field wiring using the terminal block, and then insert the terminal block

All I/O Web Page include the I/O module specifications, pin assignments and wiring connections.

For example, Pin Assignments and Wiring connections for the I-87054W module are as follows:

http://www.icpdas.com/root/product/solutions/remote_io/rs-485/i-8k_i-87k/i-87054w.html

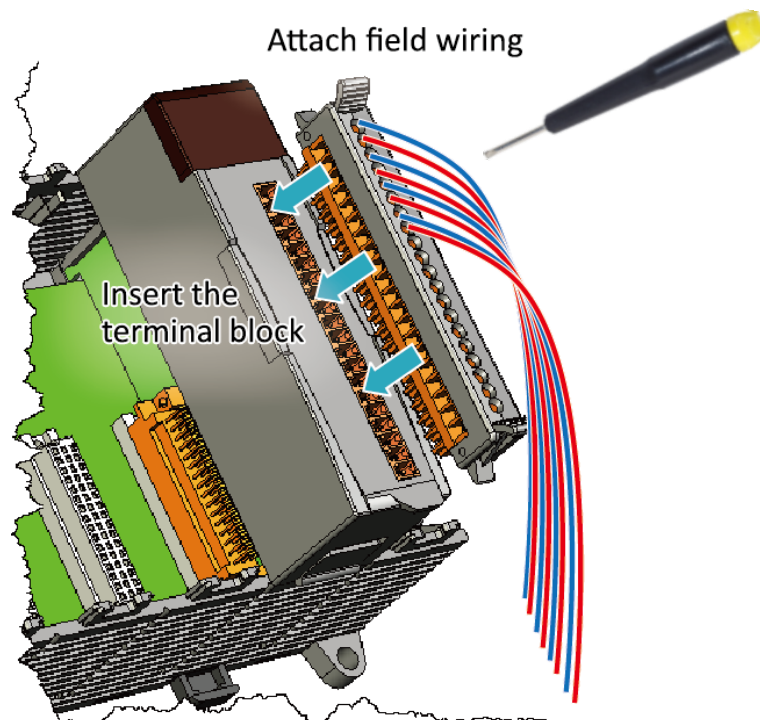

2.4. Committing EWF to Allow Settings to Be Saved

The EWF is a safety mechanism that provides the ability to control write protection of the XP-8000 system built in C: drive. Any changes made to the system are lost when the start restarts while EWF is enabled, unless they are committed to the system.

For more details about the EWF, please refer to section 3.4. Configuring the EWF Manager.

Step 1: Double-click the PAC Utility on the desktop

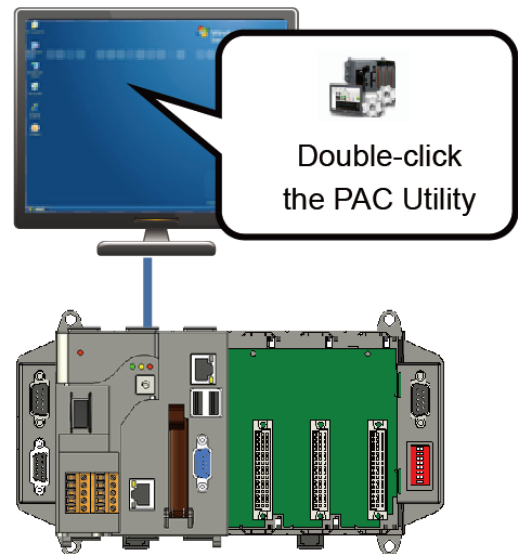

Step 2: Click the EWF Operation tab, select the Commit option, and then click Apply button

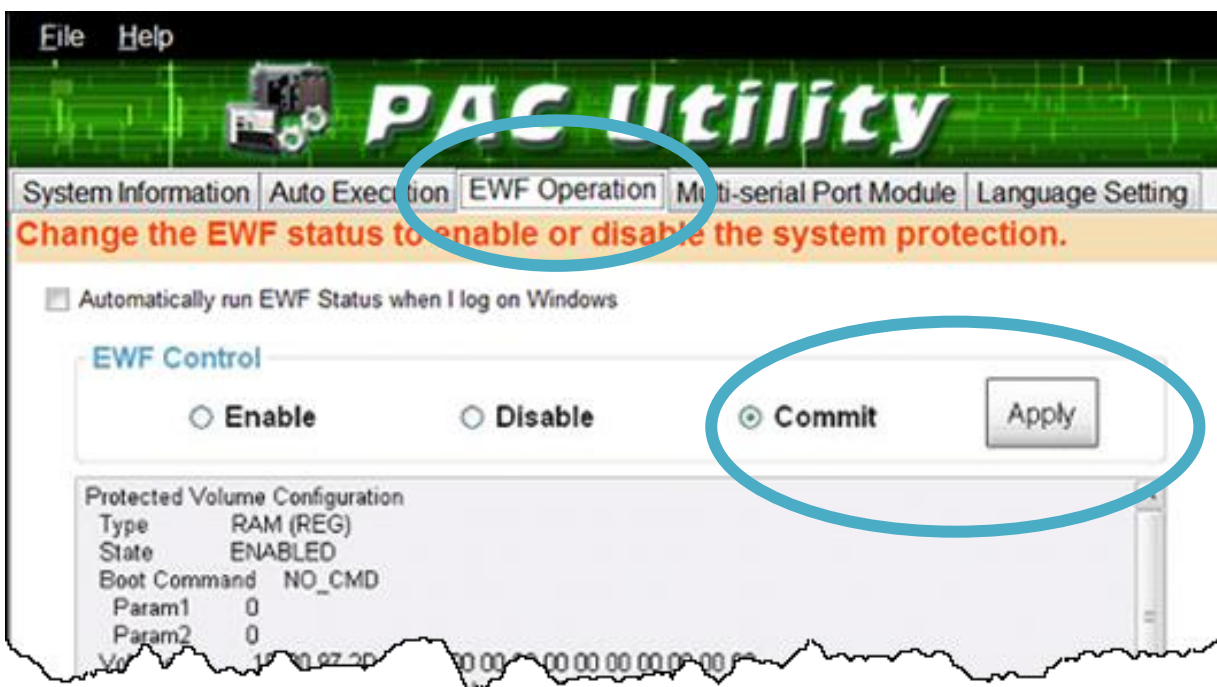

Step 3: Click OK/Yes button to save changes to the disk

For XP-8x41 and XP-8x41-Atom:

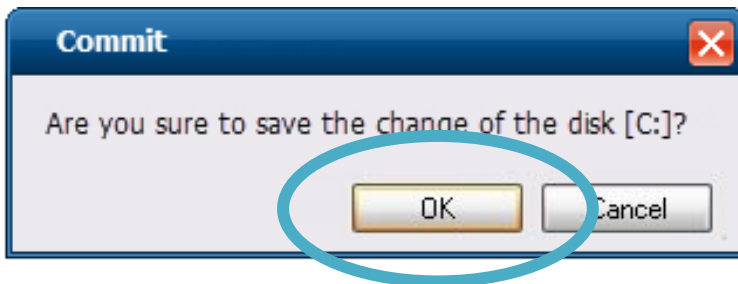

For XP-8x31-WES7:

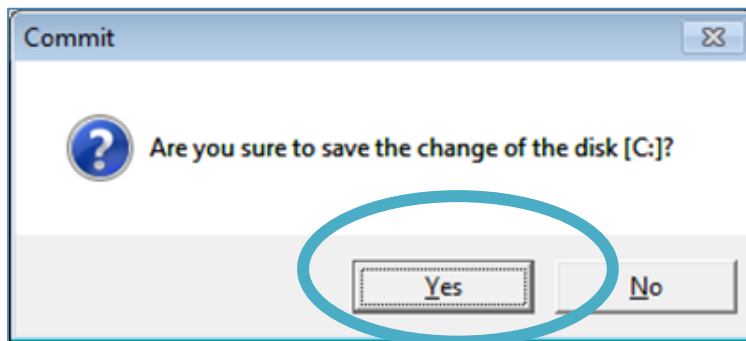

Step 4: Log off the XP-8000, and then login again for changes to take effect

For XP-8x41 and XP-8x41-Atom:

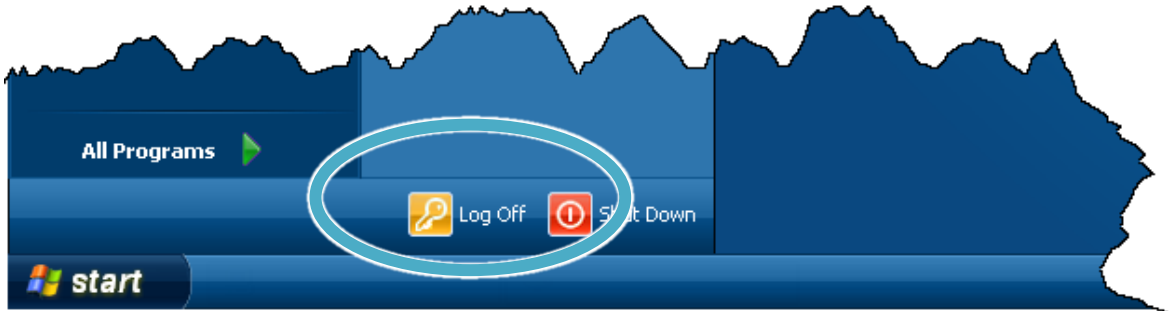

For XP-8x31-WES7:

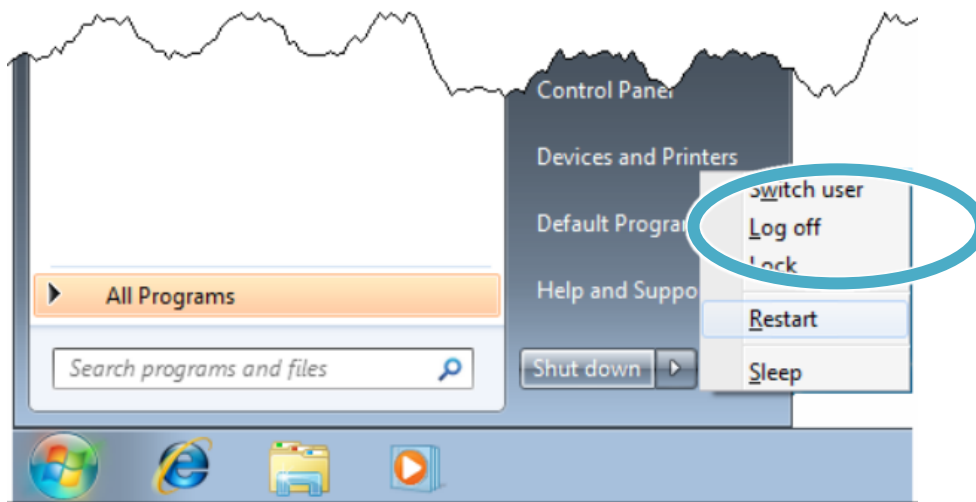

Tips & Warnings



The Enhanced Write Filter (EWF) is a Windows embedded utility for protecting the C:\ drive of the XP-8000. If you need to change any of the settings you have configured, you must manage the EWF to commit the changes on the next login or next reboot. These changes will take effect on the login or next reboot.

2.5. Changing the User Interface Language

The **Regional and Language Settings** is a WES 2009/7 functionality that allows users to change the XP-8000 user interface with your native language.

Step 1: Double-click the PAC Utility on the desktop

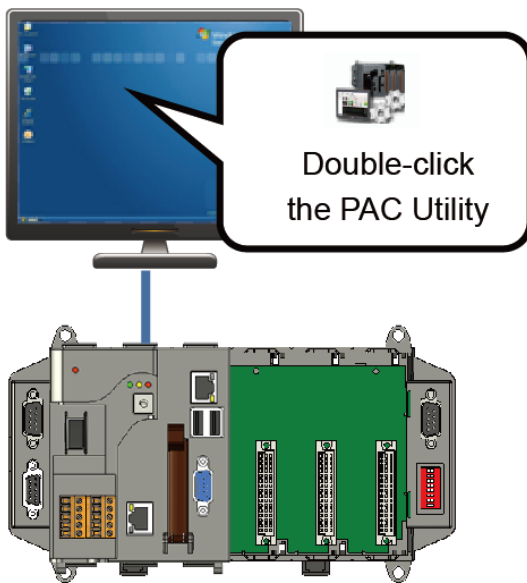

Step 2: Click the Language Setting tab, choose your preferred language that you want to use for XP-8000 menus and dialogs, and then click Apply button

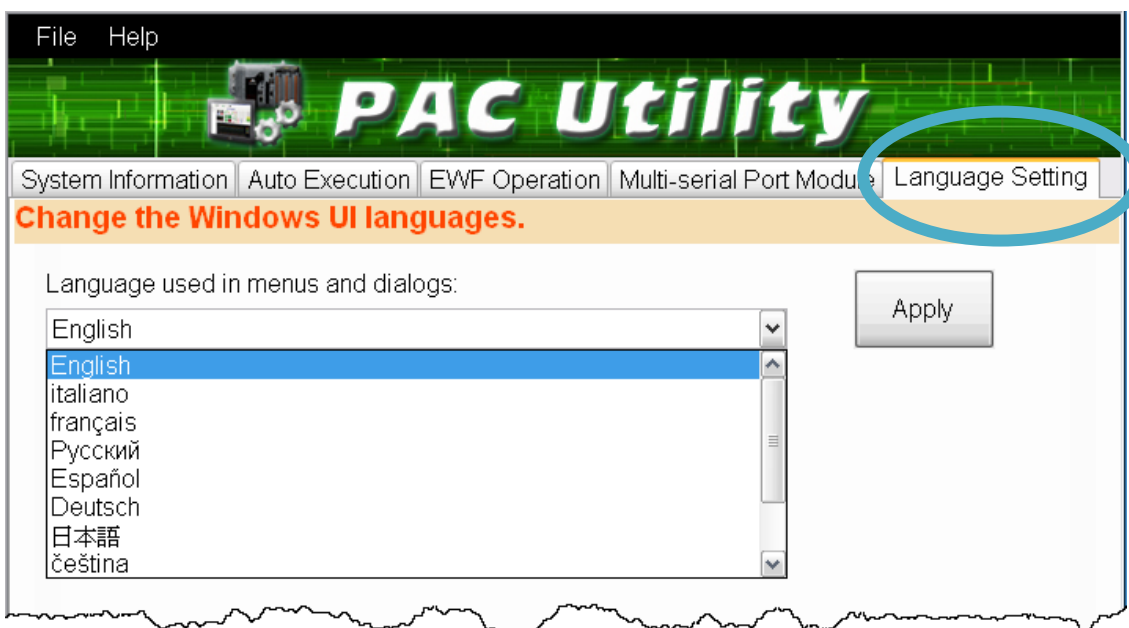

Step 3: Click the EWF Operation tab, select the Commit option, and then click Apply button

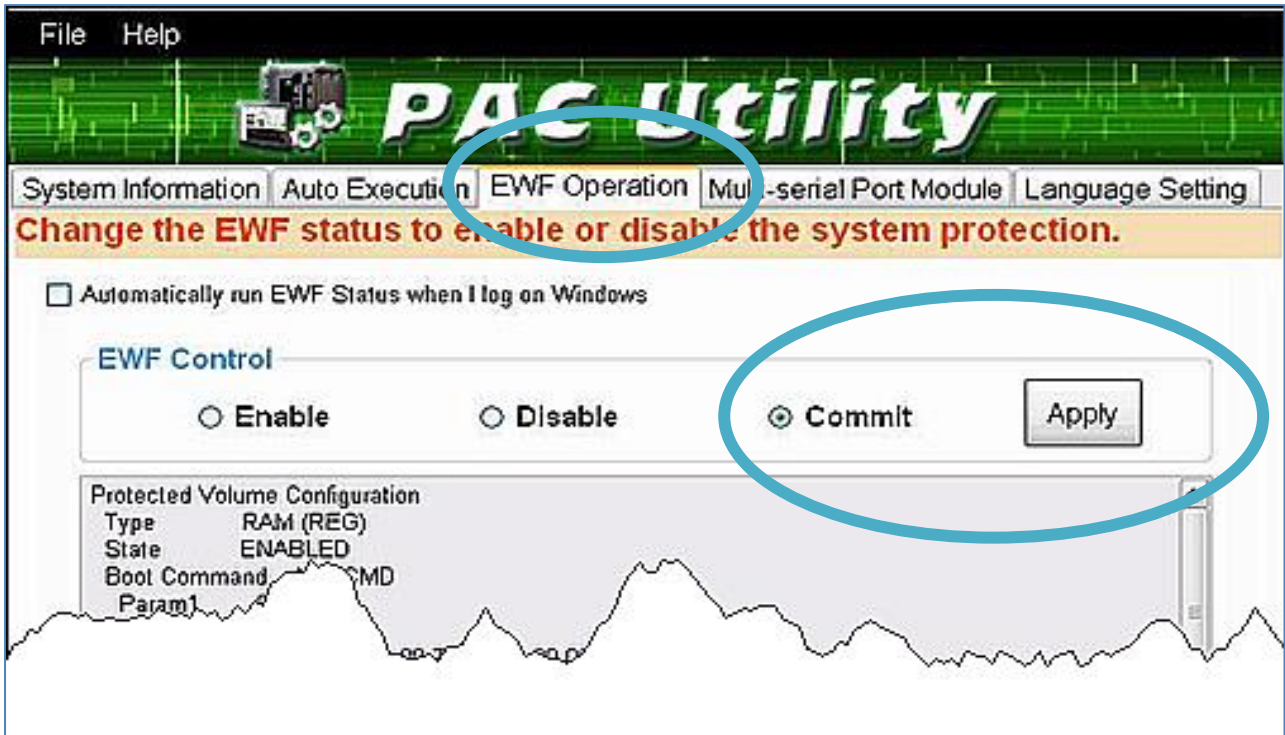

Step 4: Click OK/Yes button to save changes to the disk

For XP-8x41 and XP-8x41-Atom:

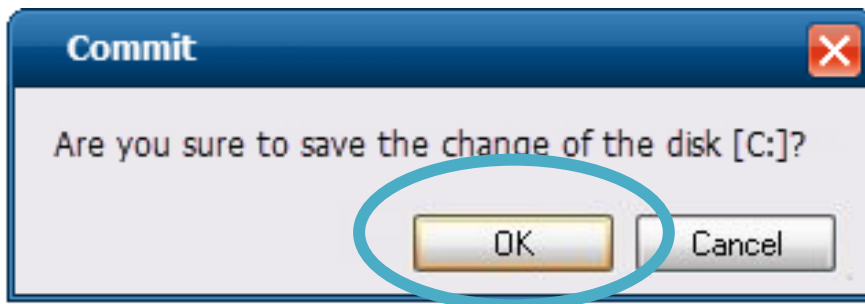

For XP-8x31-WES7:

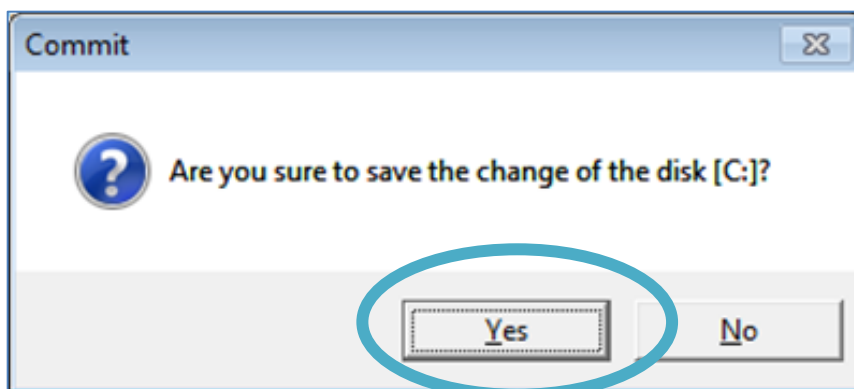

Step 5: Log off the XP-8000, and then login again for changes to take effect

For XP-8x41 and XP-8x41-Atom:

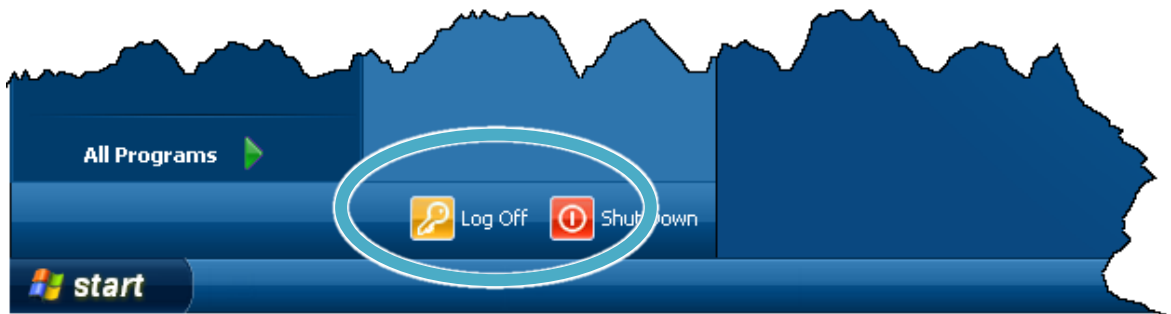

For XP-8x31-WES7:

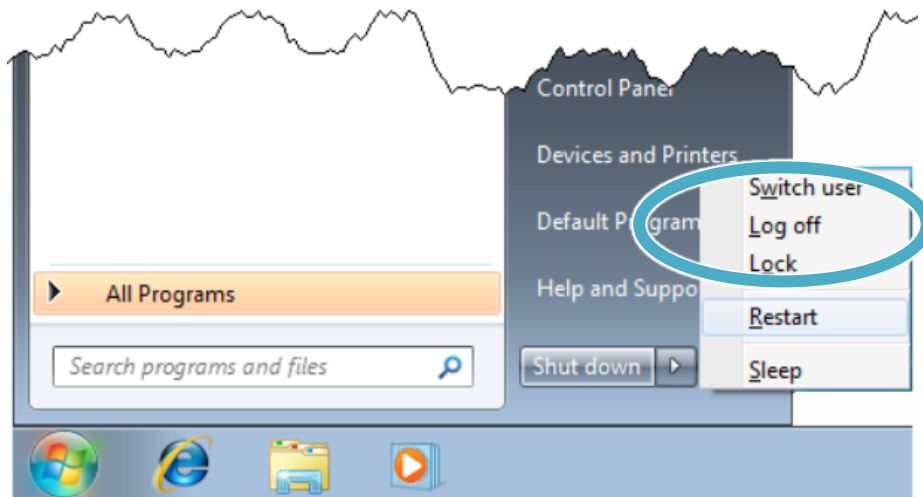

2.6. Using DCON Utility Pro Configure I/O Modules

DCON Utility Pro allows users to configure and manage the I/O modules via Ethernet or serial ports (RS-232/RS-485).

Step 1: Double-click the DCON Utility Pro on the desktop

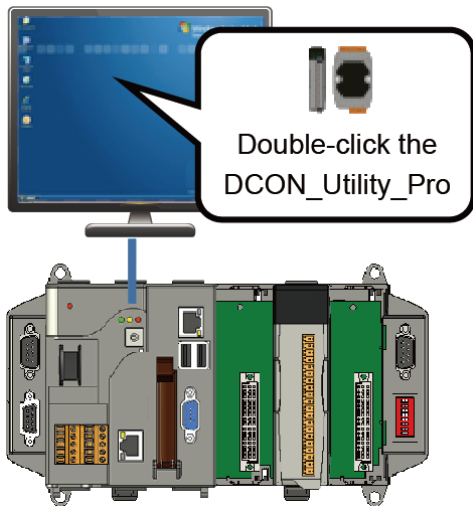

Step 2: Click the



button

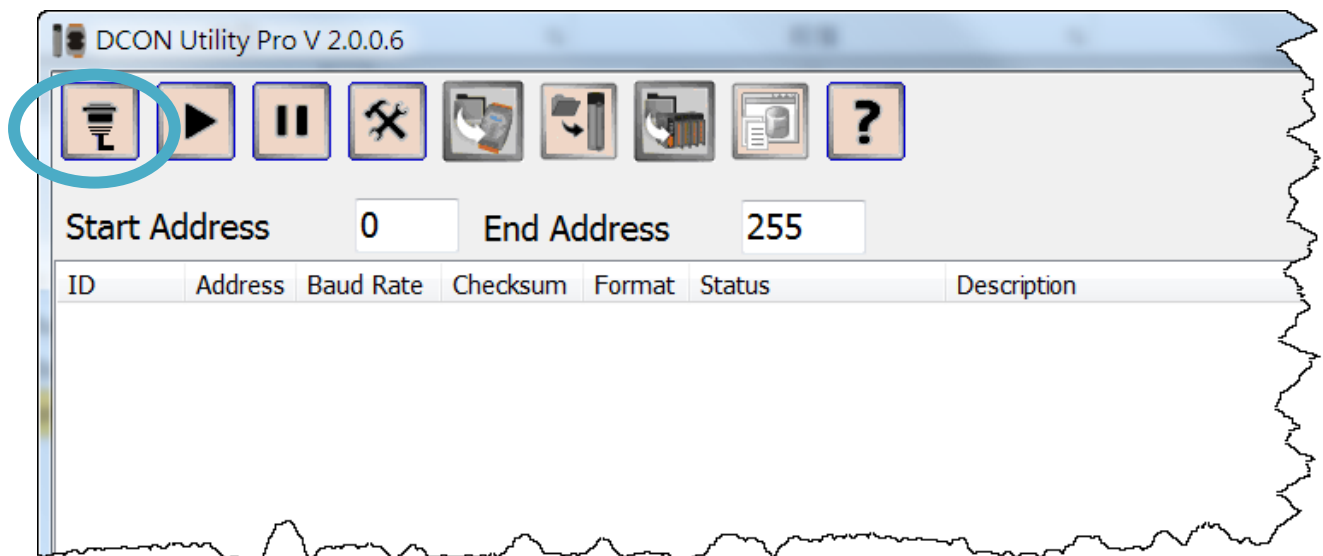

Step 3: Configure the communication settings

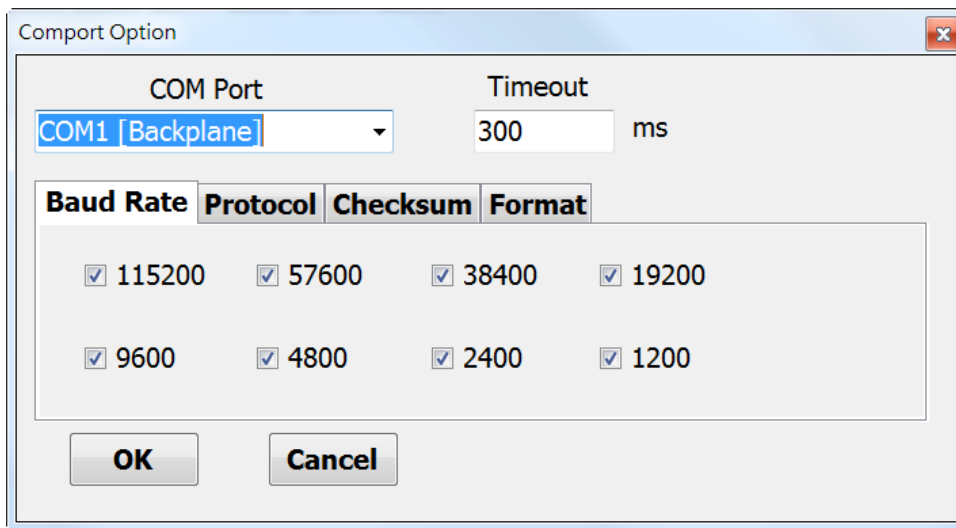

Tips & Warnings



The COM port settings for expansion I/O modules are listed below.

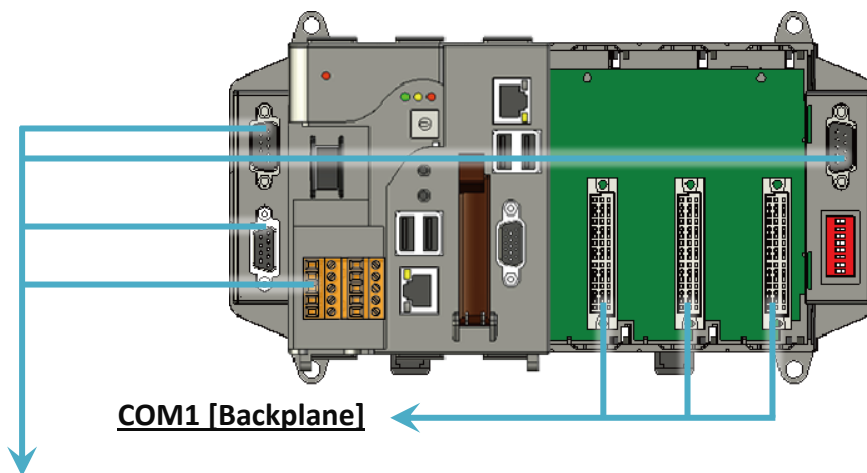

COM1 [Backplane]

COM2/3/4/5

For more information on these COM port selections, please refer to the specification of the pin assignments in section 1.3. Overview

Step 4: Click the  button to scan the I/O module

Step 5: Click the module name to enter the I/O configure form, and then configure the I/O module

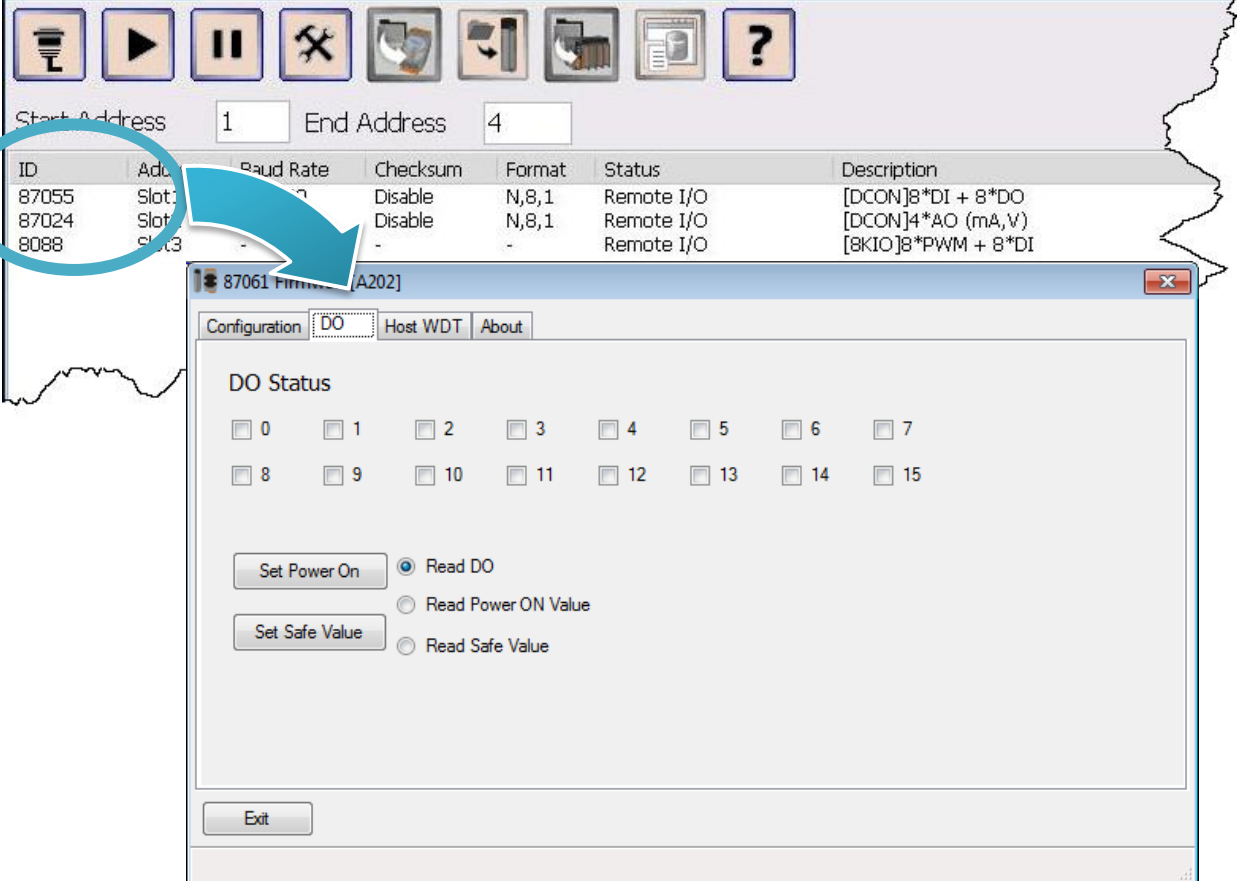

ID	Address	Baud Rate	Checksum	Format	Status	Description
87055	Slot 1	9600	Disable	N,8,1	Remote I/O	[DCON]8*DI + 8*DO
87024	Slot 2	9600	Disable	N,8,1	Remote I/O	[DCON]4*AO (mA,V)
8088	Slot 3	9600	-	-	Remote I/O	[BKIO]8*PWM + 8*DI

87061 Firm... (A202)

Configuration | Host WDT | About

DO Status

0 1 2 3 4 5 6 7
 8 9 10 11 12 13 14 15

Set Power On Read DO
 Read Power ON Value

Set Safe Value Read Safe Value

Exit

3. Security and Risk

This chapter provides information of technological security risks and solutions associated with the XP-8000 services.

Security is important for XP-8000. Based on WES 2009/7, XP-8000 can avoid many security vulnerabilities. The following provides some security policy that you should consider before you develop your XP-8000.

- Administrator and User Accounts
- Windows Firewall
- IIS (Internet Information Service)
- EWF (Enhanced Write Filter)

The following table provides the default settings of the XP-8000 security policy.

Security Item	Default Settings	User Name	Password
Firewall	Enable	N/A	N/A
IIS	Enable	anonymous	Blank
EWF	Enable	N/A	N/A

3.1. Administrator and User Accounts

Based on WES, XP-8000 includes several components for managing user account names, groups, and passwords.

Account Types

Before you start creating new users on your XP-8000, you should understand the difference between the two main account types.

- **Administrators** have full control over the system. They can install software programs and hardware drivers, and they can create and modify new users and groups. Additionally, they can reset passwords, set policies, and edit the Registry. The OS identifies tasks that require administrator permissions with a Windows security icon.
- **Standard users** are permitted to log on to the computer, run programs, customize their accounts, and save files in their user folders. Users are restricted from making systemwide changes.

The First User

When XP-8000 OS reinstalls, it asks you for a user name and password, which it then uses to create your first account. This account joins the Administrators group, which has the highest set of privileges. From this account you can create and manage all other user accounts.

3.1.1. Creating and Managing User Accounts in WES 7

The Windows Control Panel provides utilities that enable you to create and manage user accounts quickly and easily. To access the relevant settings, you need to have Administrator permissions on XP-8000.

- 1) Open **Control Panel**, and then choose **User Accounts and Family Safety**



- 2) Under **User Accounts**, click **Add or remove user accounts**



3) Click **Create A New Account** to start the process of adding a new account

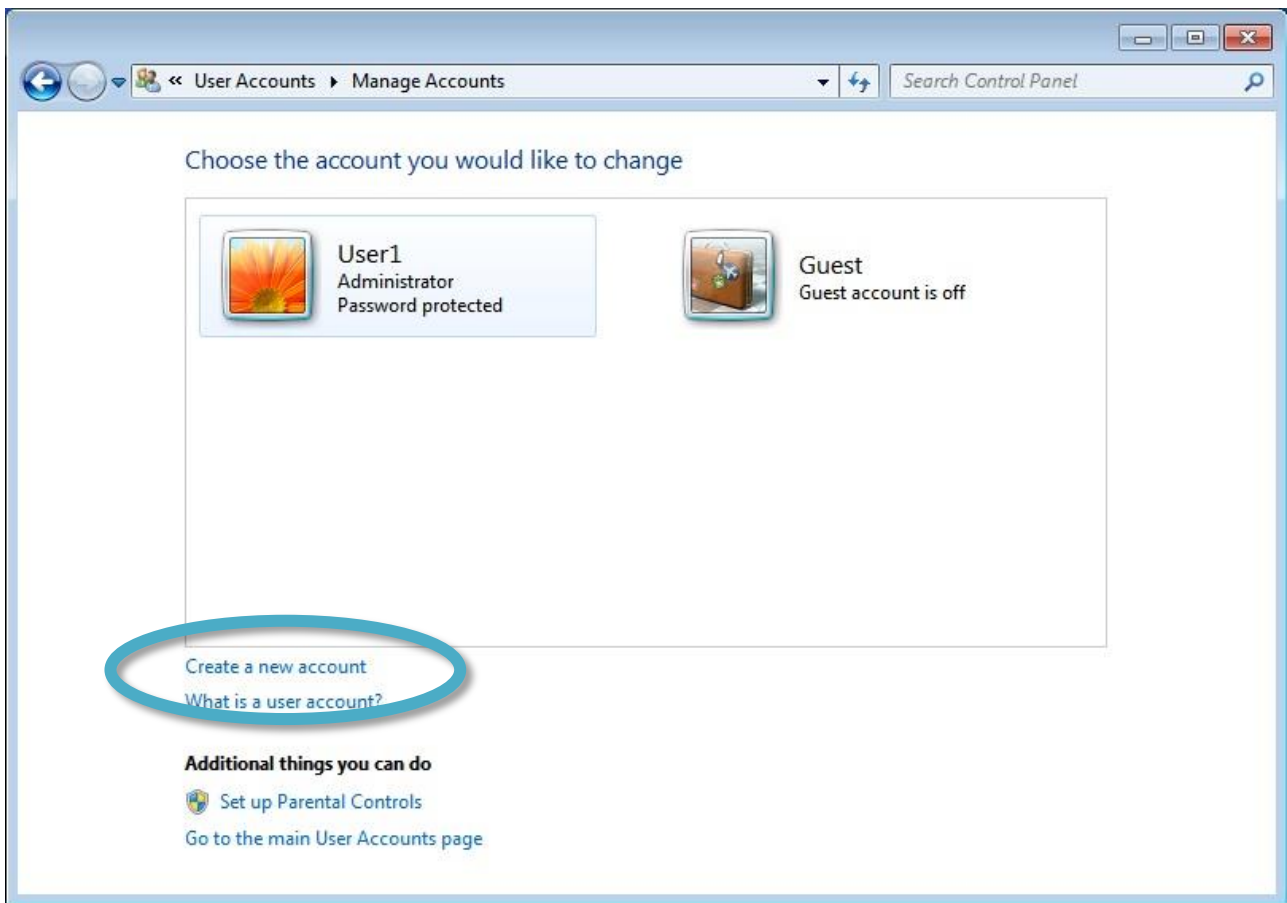

- 4) Type in the new account name, select either the Administrators or Standard Users user type, and then click **Create Account**

By default, Windows assigns no password; you can make one by clicking on that user's icon and selecting Create a password. Alternatively, you can leave it blank to allow the user to set a password when they first log on.

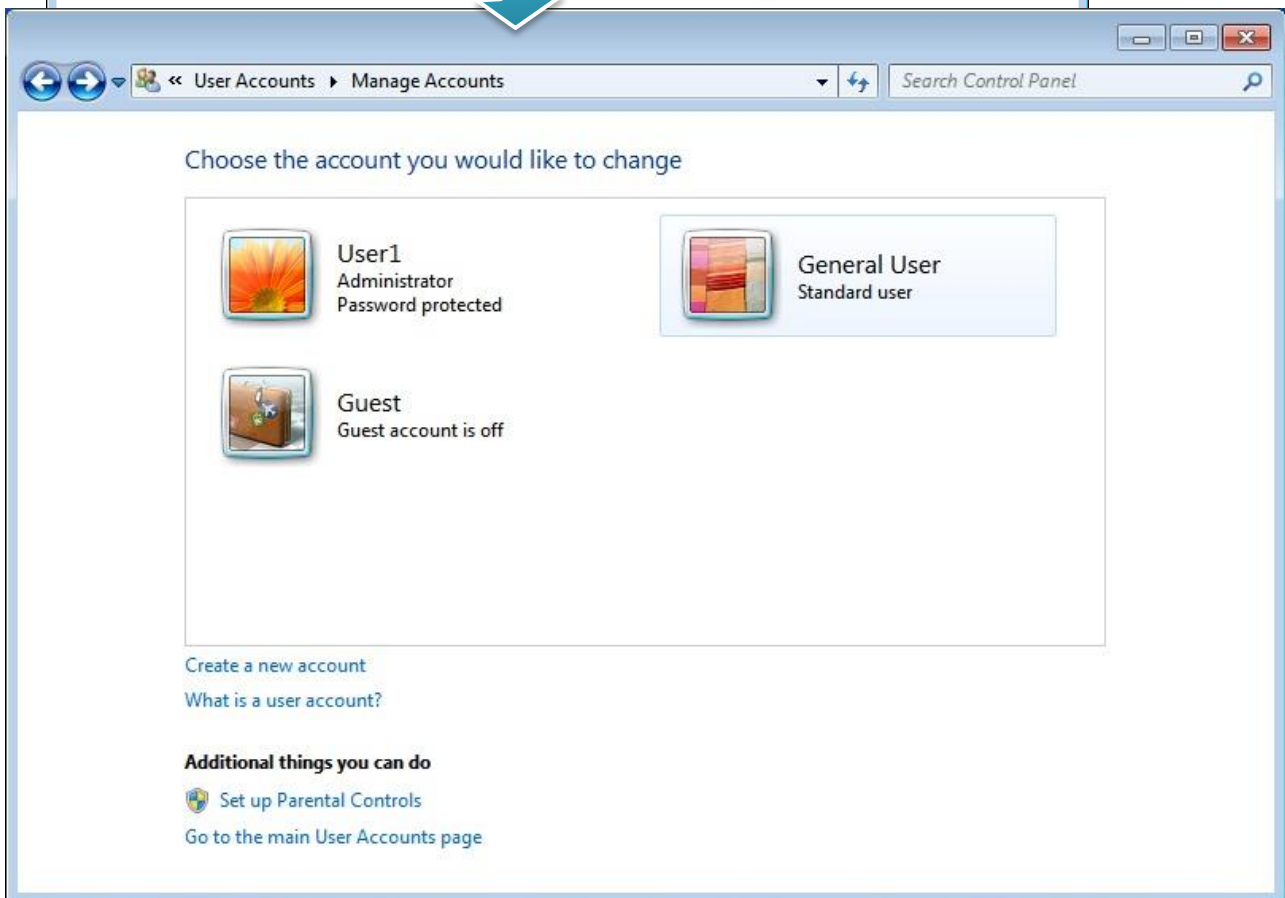
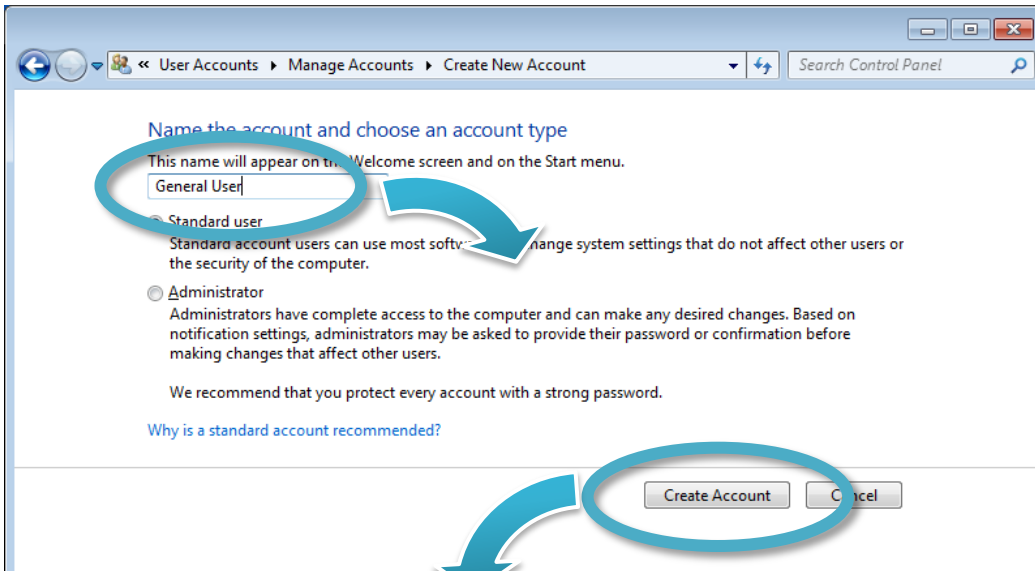

5) Manage the user account

There are several different operations that are commonly performed when managing user accounts. You can access these by clicking the name or icon of an account in the Manage Accounts window.

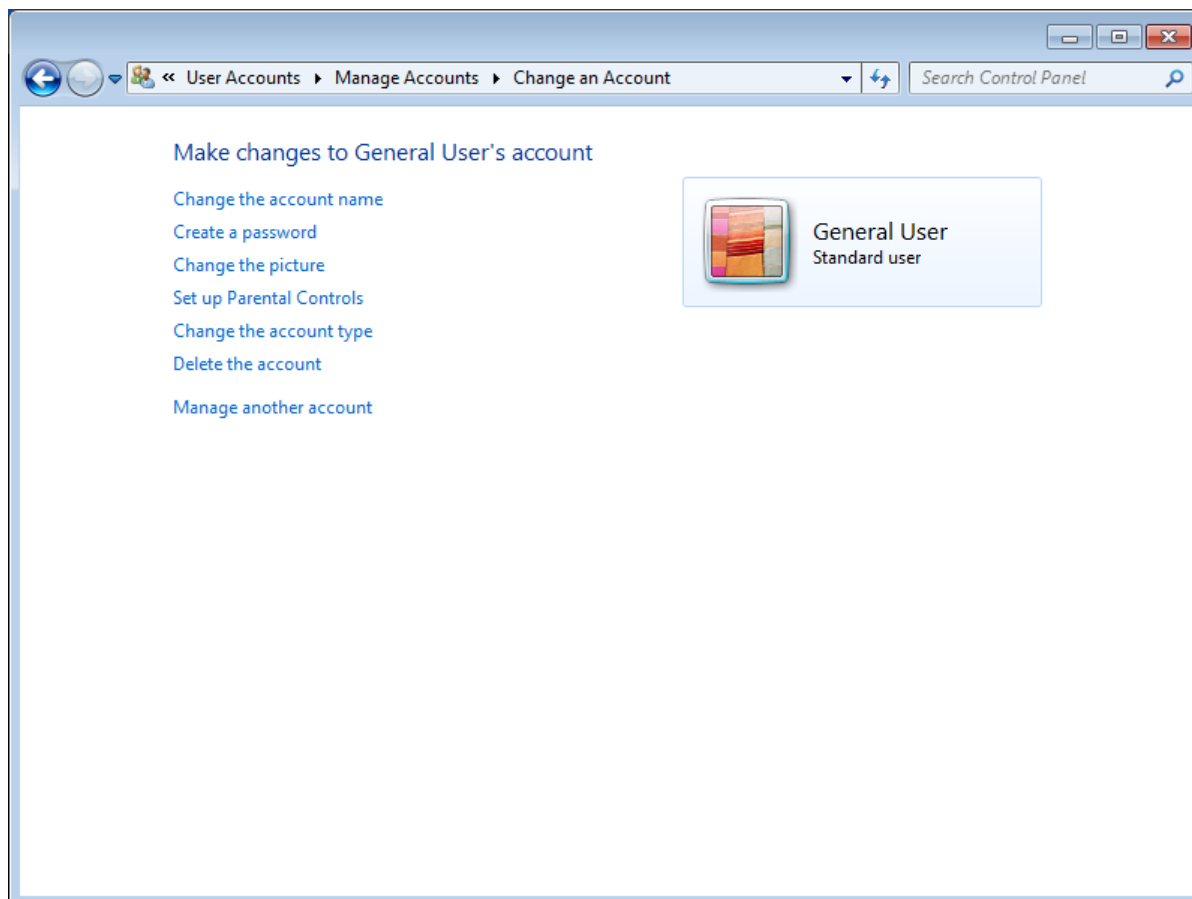

The options include the following:

- Change The Account Name
- Change The Password (or Create A Password if the account does not currently have one)
- Remove The Password (if one is currently configured)
- Change The Picture
- Set Up Parental Controls
- Change The Account Type
- Delete The Account

3.1.2. Creating and Managing User Accounts in WES 2009

The Windows Control Panel provides utilities that enable you to create and manage user accounts quickly and easily. To access the relevant settings, you need to have Administrator permissions on XP-8000.

- 1) Open **Control Panel**, and then choose **User Accounts**

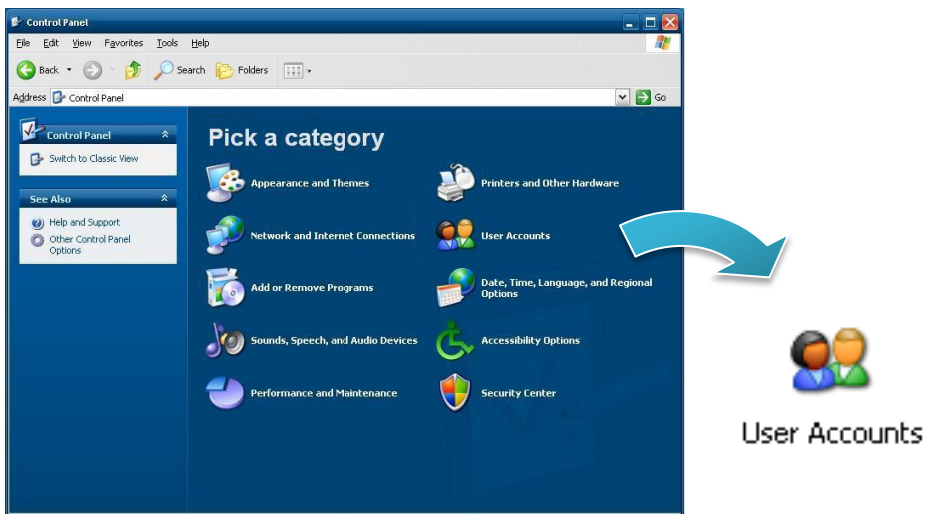

- 2) Click **Create an account**

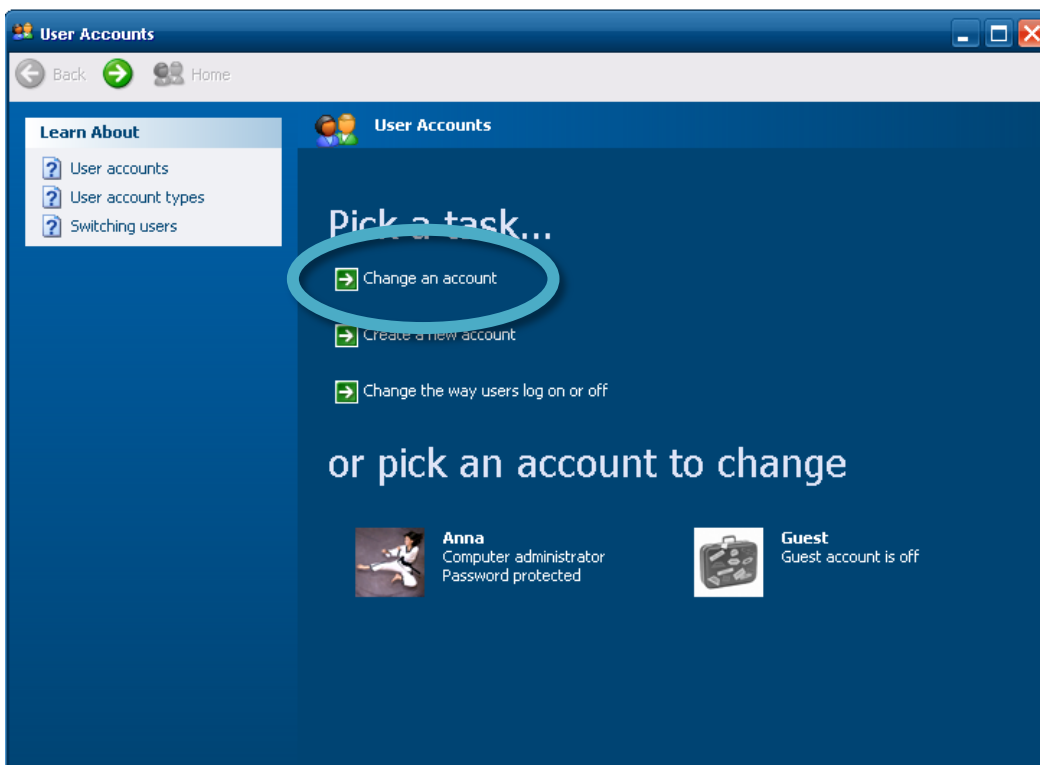

3) Type in the new account name, and then click **Next >**

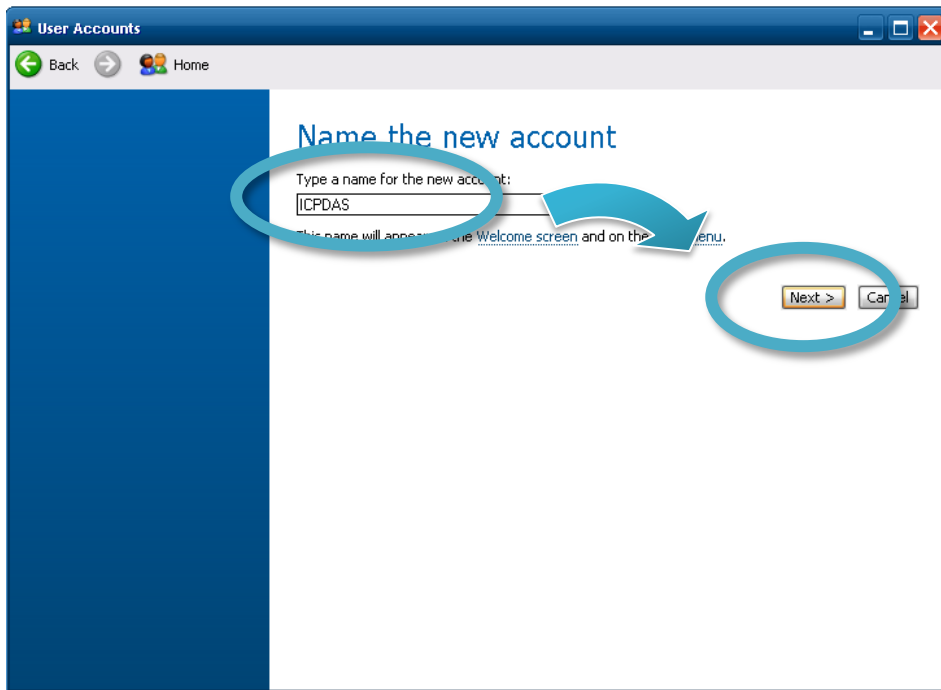

4) Select the desired account type, and then click **Create Account**

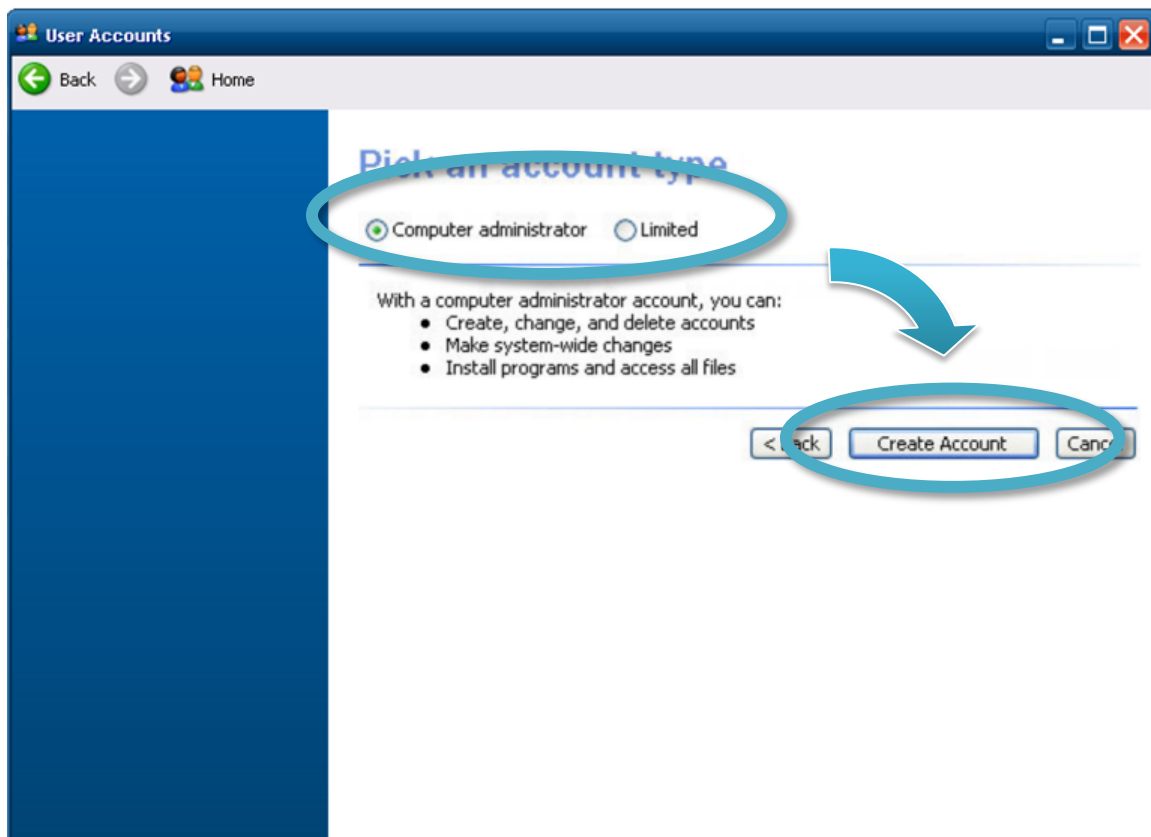

5) Manage the user account

There are several different operations that are commonly performed when managing user accounts. You can access these by clicking the name or icon of an account in the Manage Accounts window.

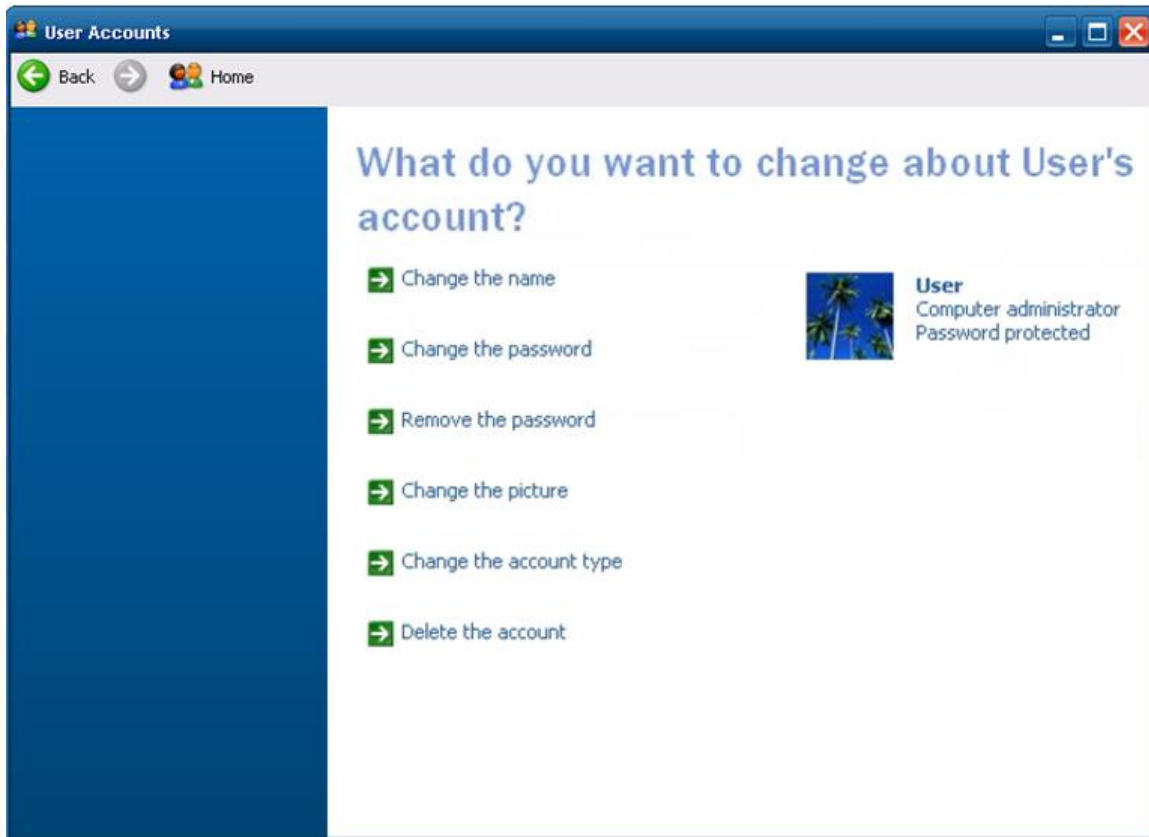

The options include the following:

- Change the name
- Change the password
- Remove the password
- Change the picture
- Change the account type
- Delete the account

3.2. Windows Firewall

Based on WES, XP-8000 Firewall with Advanced Security and the related firewall technologies documented here enable user to share Internet connections, protect connections using a firewall, and provide Network Address Translation (NAT).

3.2.1. Enabling and disabling firewall in WES 7

You shouldn't turn off Windows Firewall unless you have another firewall turned on. Turning off Windows Firewall might make your XP-8000 (and your network, if you have one) more vulnerable to unauthorized access to your network.

- 1) Open **Control Panel**, and then choose **System and Security**

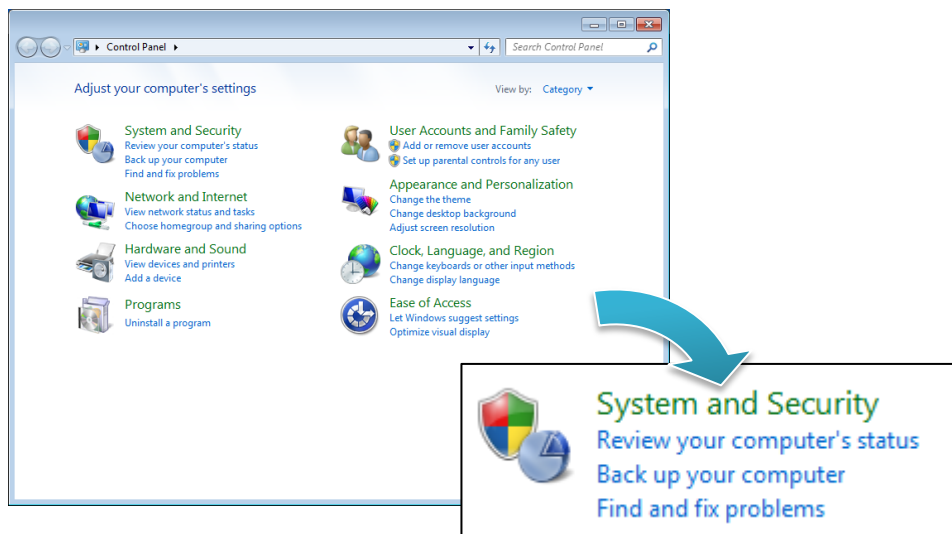

- 2) Click **Windows Firewall**



3) Click **Turn Windows Firewall On or Off** in the left pane of the window

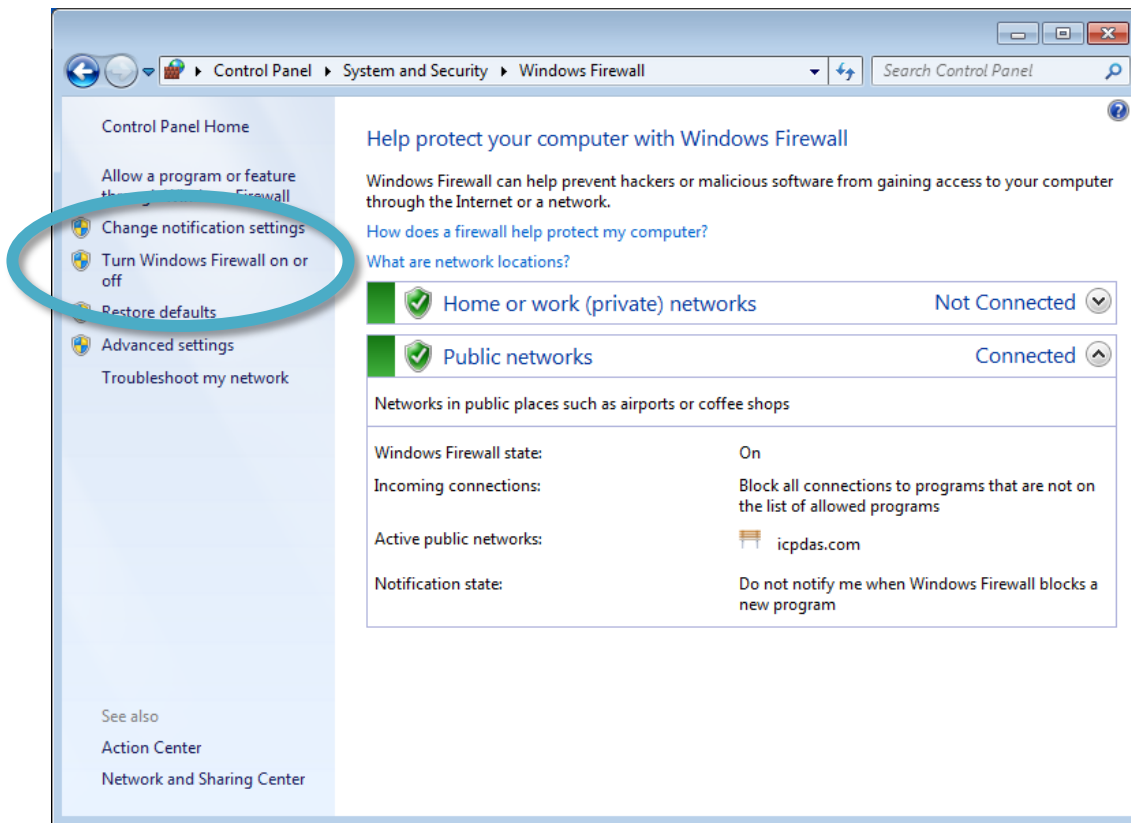

4) As Customize Settings page, enable/disable the Windows Firewall, and then click **OK**

- Click **Turn on Windows Firewall** to enable Windows Firewall.
- Click **Turn off Windows Firewall (not recommended)** to disable Windows Firewall.

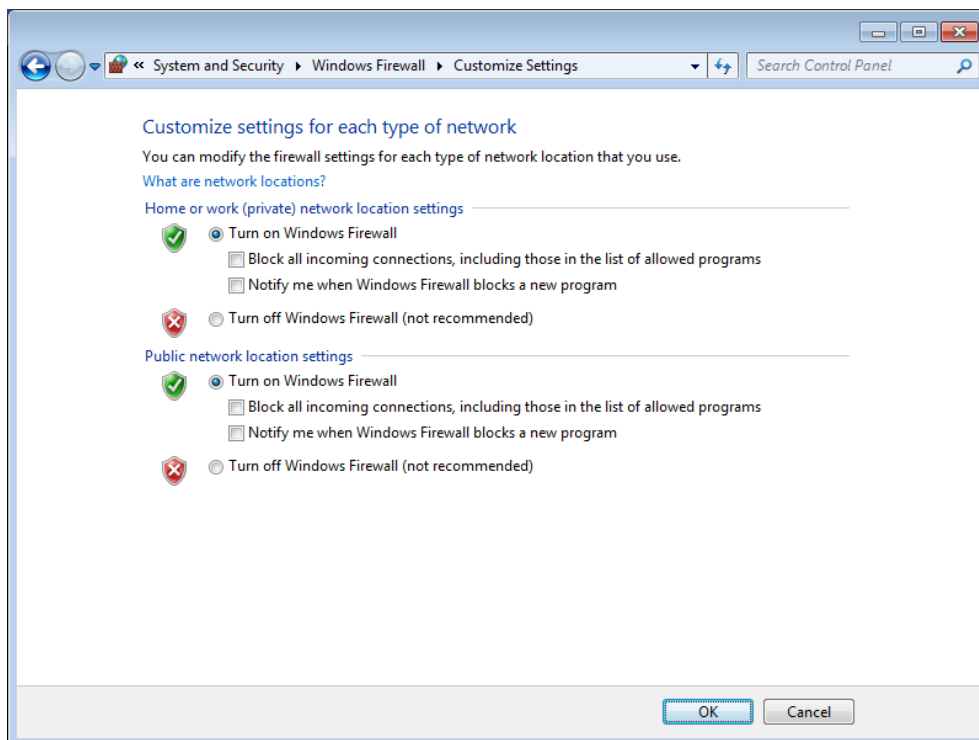

3.2.2. Enabling and disabling firewall in WES 2009

You shouldn't turn off Windows Firewall unless you have another firewall turned on. Turning off Windows Firewall might make your XP-8000 (and your network, if you have one) more vulnerable to unauthorized access to your network.

- 1) Open **Control Panel**, and then choose **Security Center**

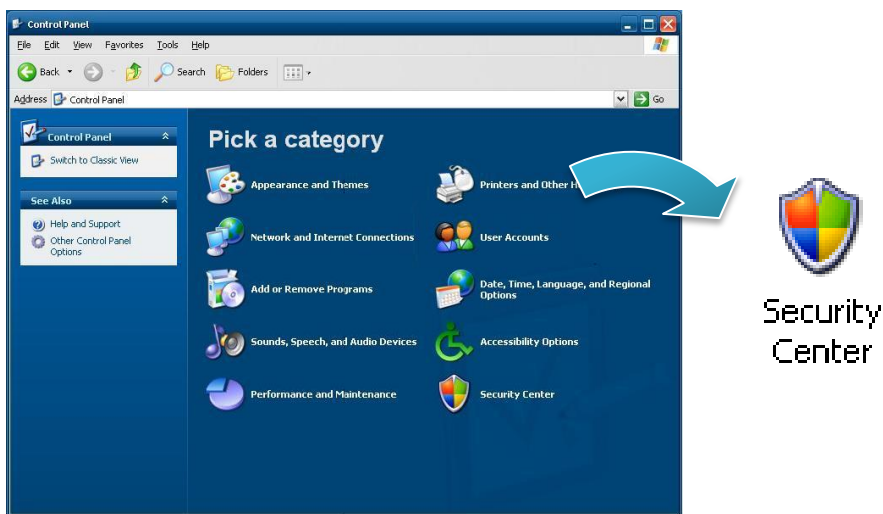

- 2) Click **Windows Firewall**



3) Enable/disable the Windows Firewall, and then click **OK**

- Click **On (recommended)** to enable Windows Firewall.
- Click **Off (not recommended)** to disable Windows Firewall.

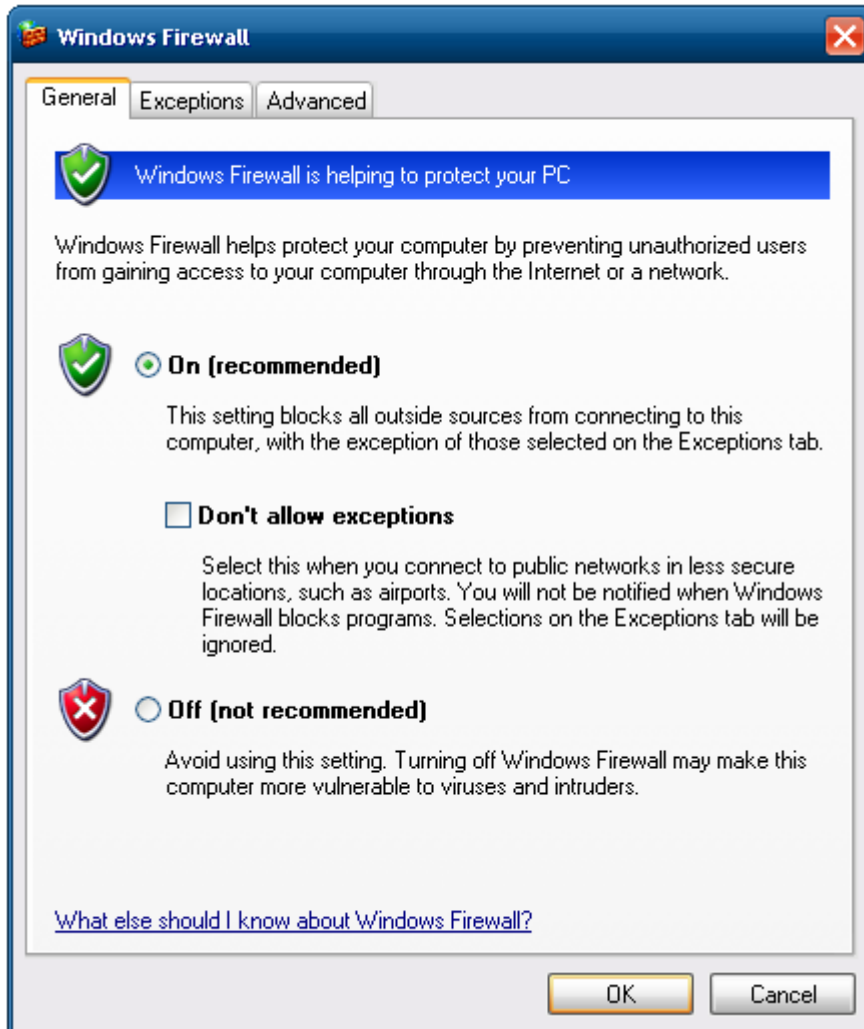

3.3. IIS

IIS creates a default Web site configuration on your hard disk at the time of installation. You can use the \Inetpub\Wwwroot directory to publish your Web content, or create any directory or virtual directory you choose. The File Transfer Protocol (FTP) service must be installed and started in order to create an FTP site. It is not installed by default.

Tips & Warnings



You must be a member of the Administrators group on the local computer to configure the IIS.

3.3.1. Starting IIS Manager in WES 7

IIS Manager is a graphical interface for configuring your application pools or your Web, FTP, SMTP, or NNTP sites. With IIS Manager, you can configure IIS security, performance, and reliability features. You can add or delete sites; start, stop, and pause sites; backup and restore server configurations; and create virtual directories for better content management, to name only a few of the administrative capabilities. In previous releases of IIS, this tool was called the Internet Service Manager.

- 1) Open **Control Panel**, and then choose **System and Security**

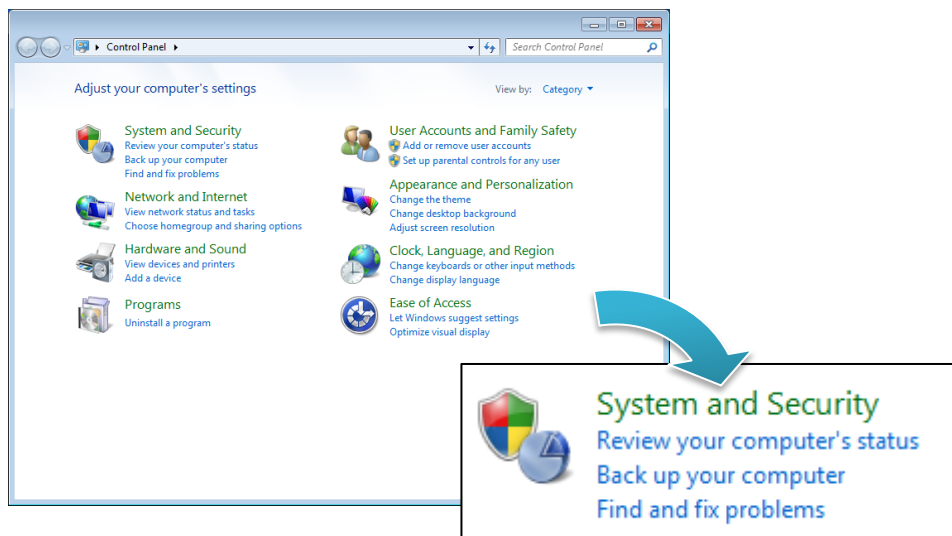

- 2) Click **Internet Information Services (IIS) Manager**



3.3.2. Creating a new FTP site in WES 7

IIS Manager creates a default FTP site during the FTP services installation. You can use the \Inetpub\Ftproot directory to publish your content, or you can create another directory.

- 1) Open **IIS Manager**
- 2) In the **Connections** pane, right-click the **Sites** node in the tree and click **Add FTP Site**, or click **Add FTP Site** in the **Actions** pane

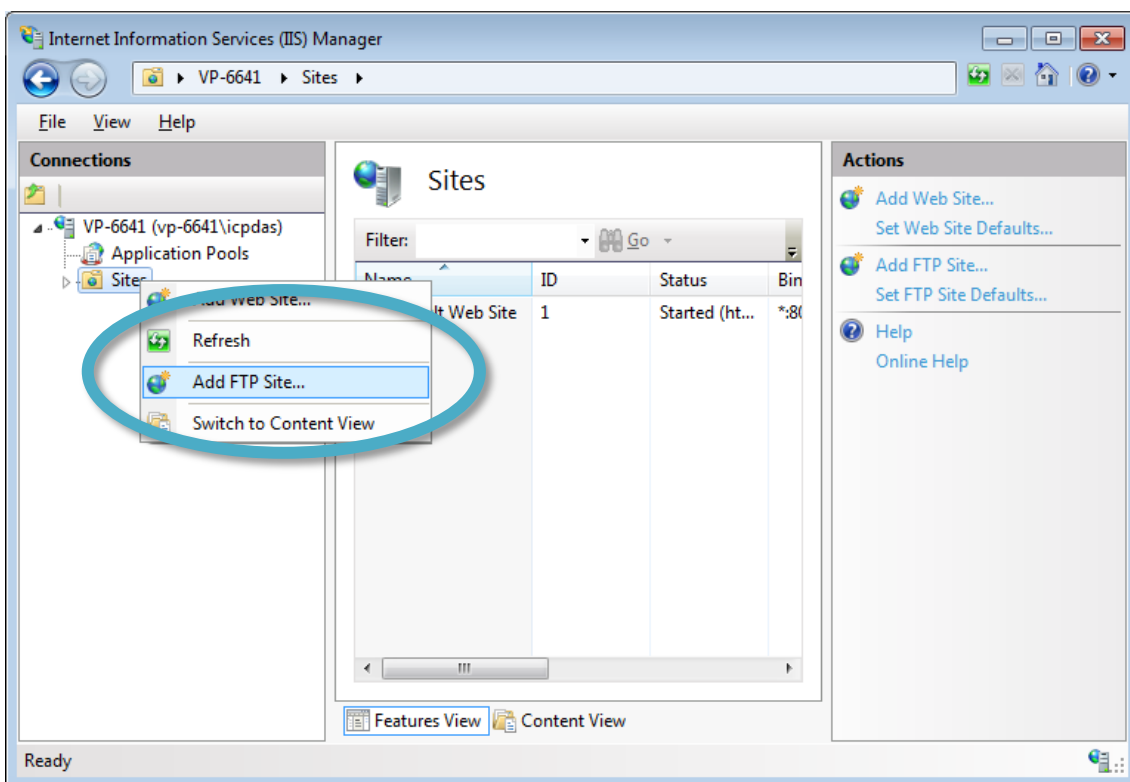

- 3) Type the name, and then select the Physical path (The default path is c:\inetpub\ftproot)

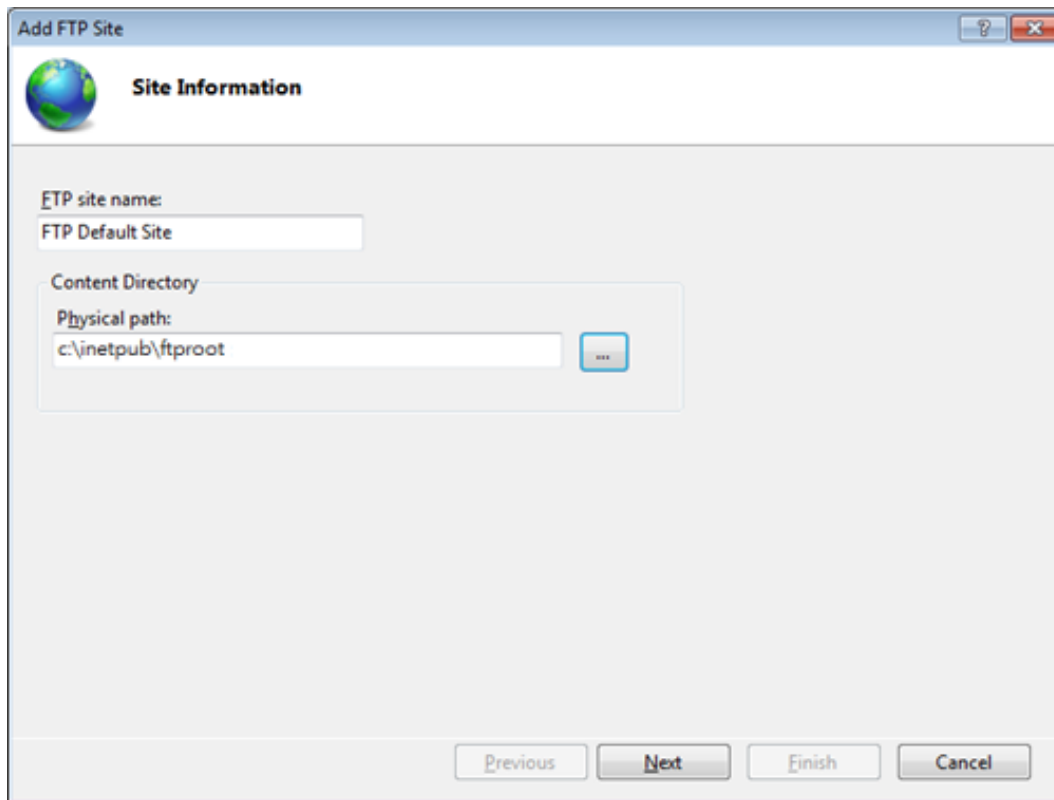

- 4) Click on the drop down arrow and choose the IP address of your XP-8000, and then click the **Next**

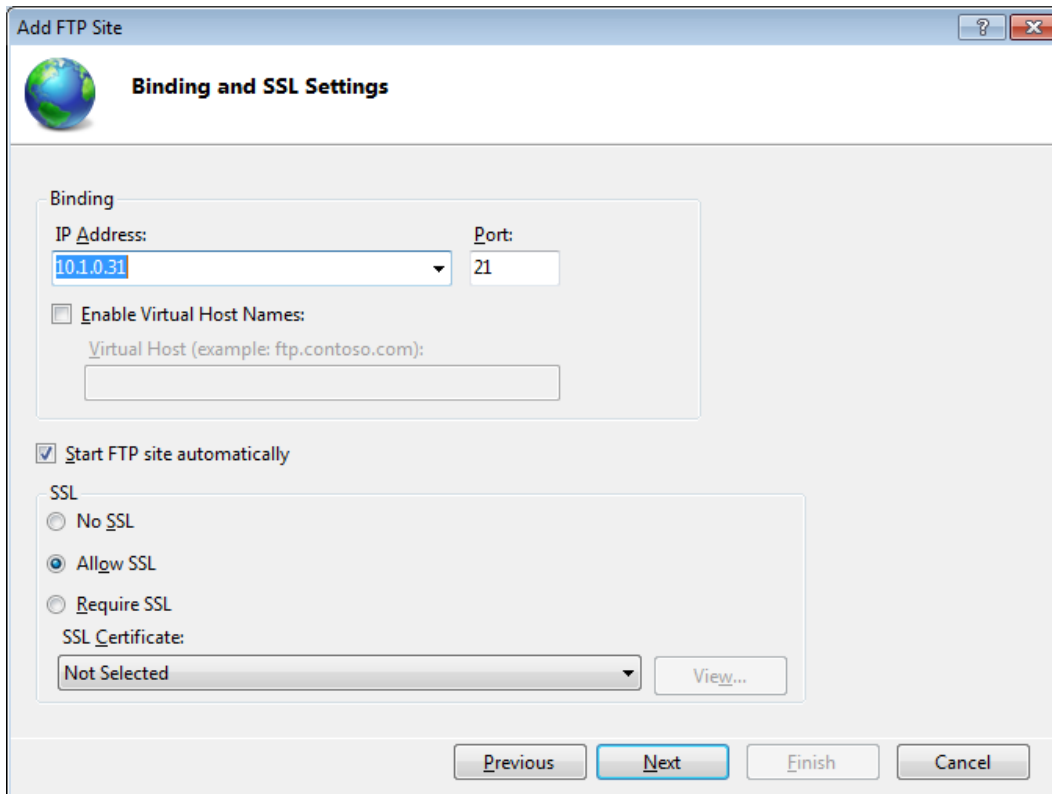

- 5) Click on the drop down arrow and choose the All users, and then select the **Read and Write**, and then click the **Finish**

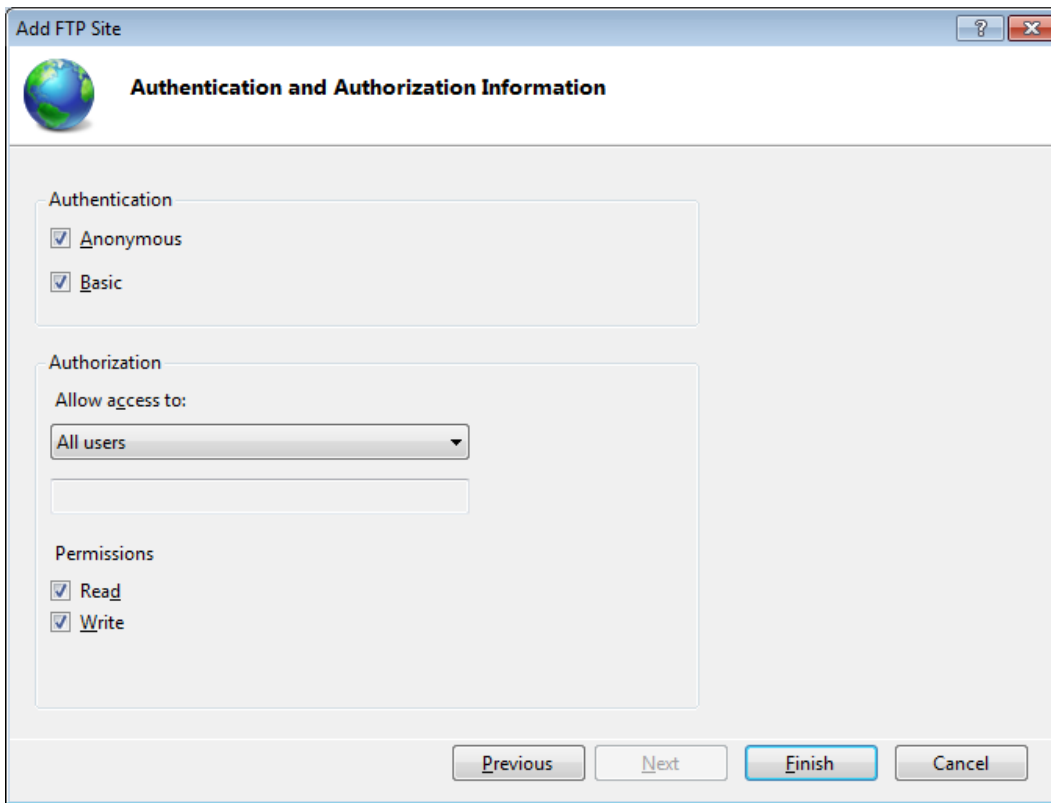

- 6) Open **Control Panel**, and then choose **System and Security**

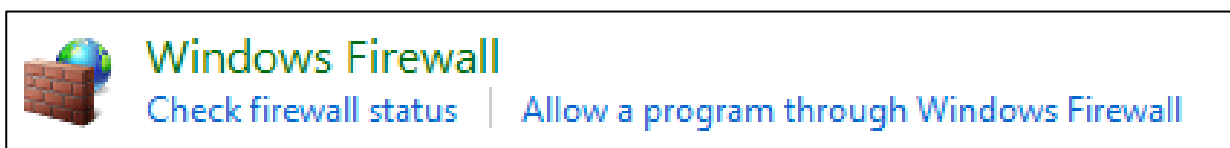
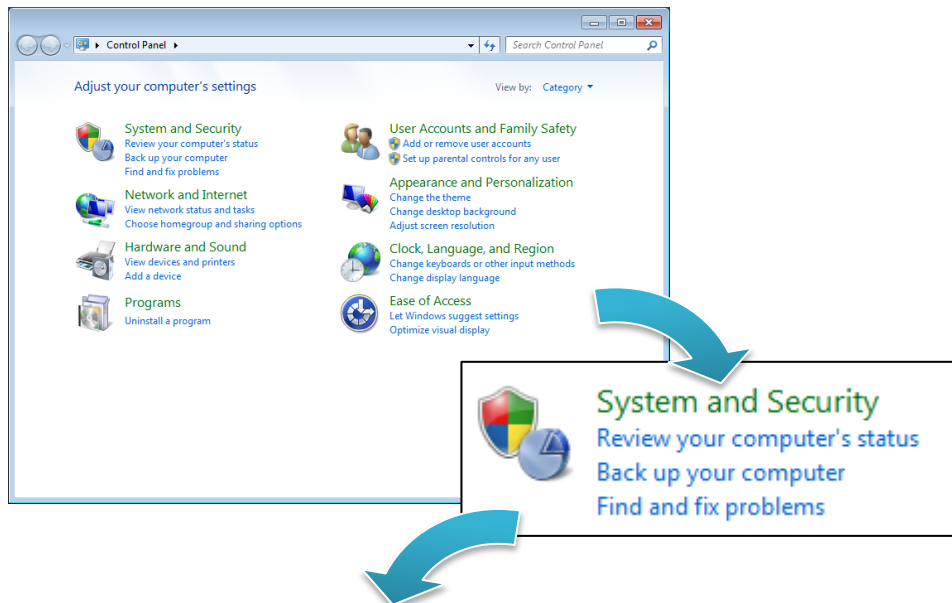

7) Select the **FTP Server**, and then click the **OK**

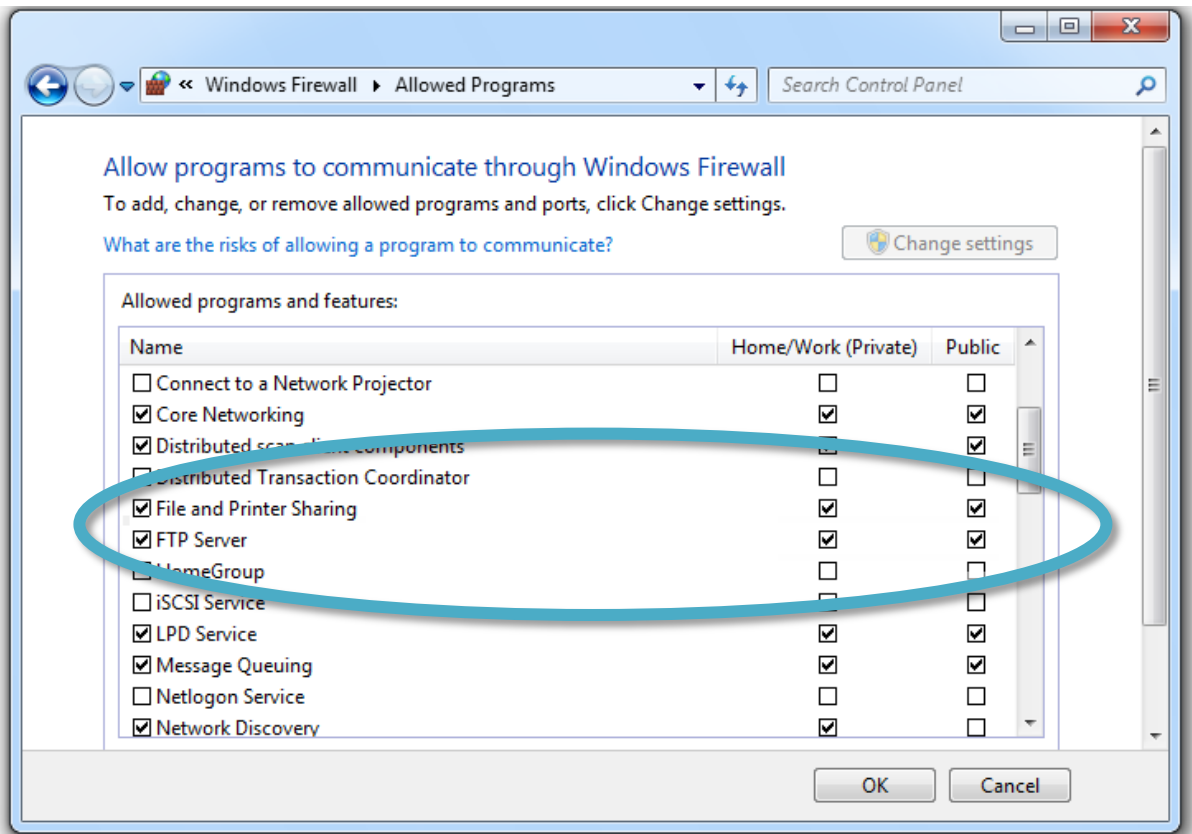

3.3.3. Starting IIS Manager in WES 2009

IIS Manager is a graphical interface for configuring your application pools or your Web, FTP, SMTP, or NNTP sites. With IIS Manager, you can configure IIS security, performance, and reliability features. You can add or delete sites; start, stop, and pause sites; backup and restore server configurations; and create virtual directories for better content management, to name only a few of the administrative capabilities. In previous releases of IIS, this tool was called the Internet Service Manager.

- 1) Open **Control Panel**, and then choose **Administrative Tools**

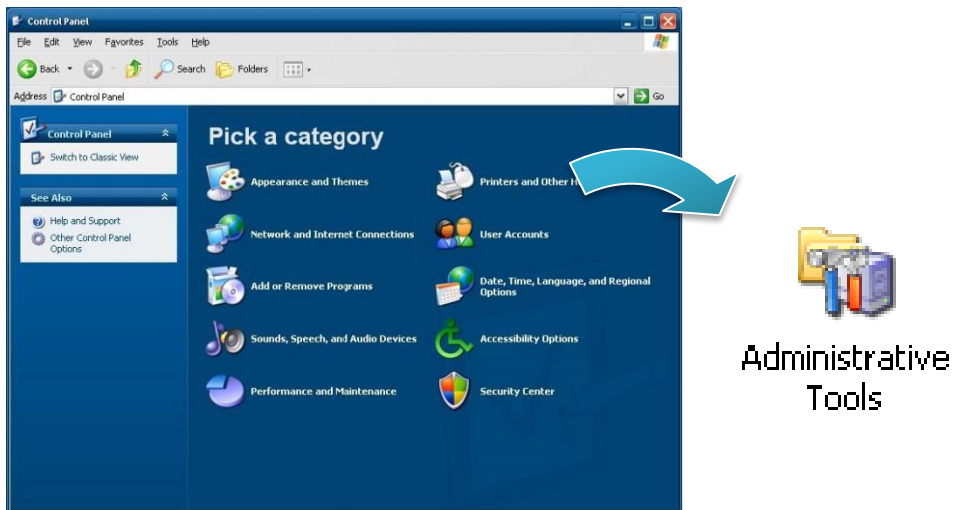

- 2) Click **Internet Information Services**



3.3.4. Creating a new FTP site in WES 2009

IIS Manager creates a default FTP site during the FTP services installation. You can use the \Inetpub\Ftproot directory to publish your content, or you can create another directory.

- 1) Go to IIS Manager, double-click the local computer, right-click the **FTP Sites** folder, point to **New**, and then click **FTP Site**

The FTP Site Creation Wizard starts.

- 2) Click **Next**
- 3) In the **Description** box, type the name of your site, and then click **Next**
- 4) Type or click the IP address (the default is **All Unassigned**) and TCP port for your site, and then click **Next**
- 5) Click the user isolation option you want, and then click **Next**
- 6) In the Path box, type or browse to the directory that contains or will contain shared content, and click **Next**
- 7) Select the check boxes for the FTP site access permissions you want to assign to your users, and then click **Next**
- 8) Click **Finish**

To change these and other settings later, right-click the FTP site, and then click Properties.

3.4. EWF Manager

The Enhanced Write Filter (EWF) protects a volume from write access. All writes to a EWF-protected volume are redirected to an overlay. These writes are stored in the overlay and made available as part of the volume. In this way, it feels like that the volume is writeable. The overlay may exist either on disk or in RAM. If desired, the data stored in the overlay may be committed to the protected volume. The following figure is an overview of EWF.

For more detailed information about Enhanced Write Filter (EWF), please refer to [http://msdn.microsoft.com/en-us/library/ms912906\(WinEmbedded.5\).aspx](http://msdn.microsoft.com/en-us/library/ms912906(WinEmbedded.5).aspx)

3.4.1. Disabling the EWF

PAC Utility allows users to easily configure EWF features.

- 1) Run the **PAC Utility**
- 2) Click the **EWF Operation**, select the **Disable**, and then click **Apply**

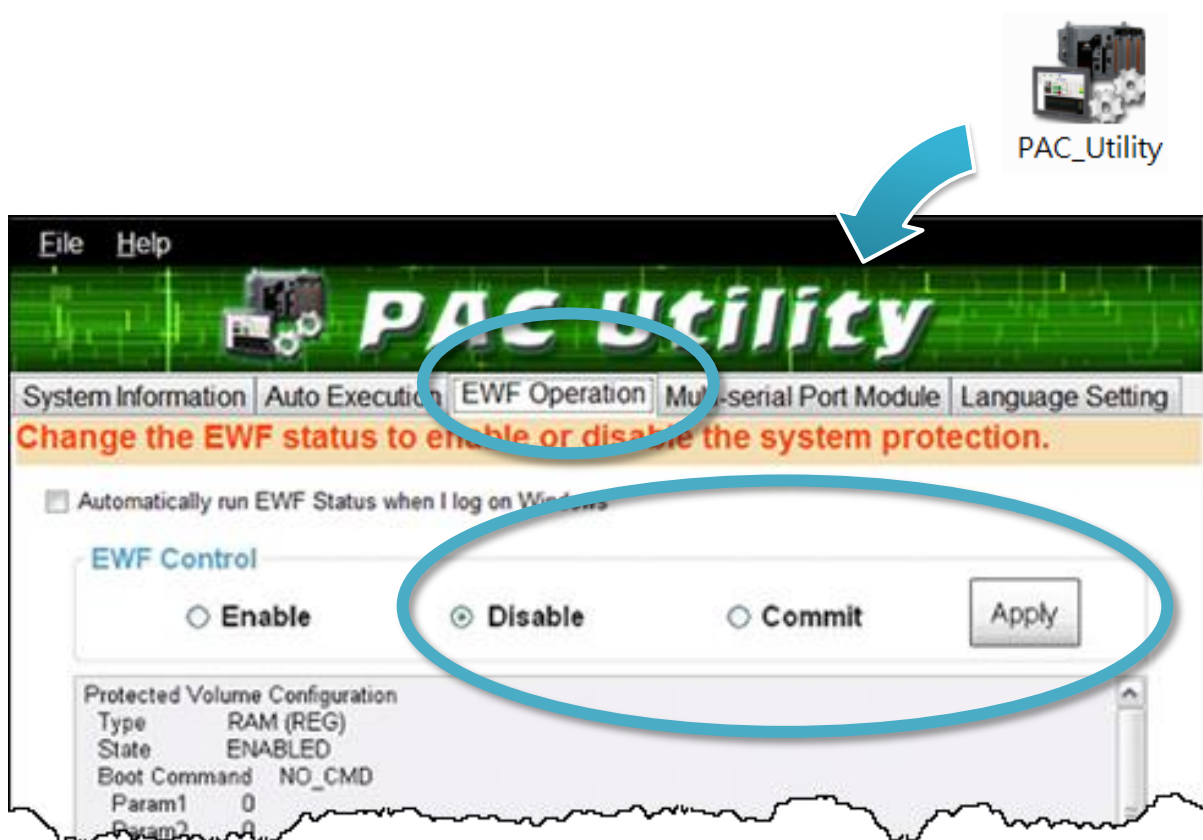

Tips & Warnings



If EWF is disabled and XP-8000 suffers sudden power off, the operating system of XP-8000 may be damaged or incomplete.

3) Click **OK/Yes** to save changes to the disk

For XP-8x41 and XP-8x41-Atom:

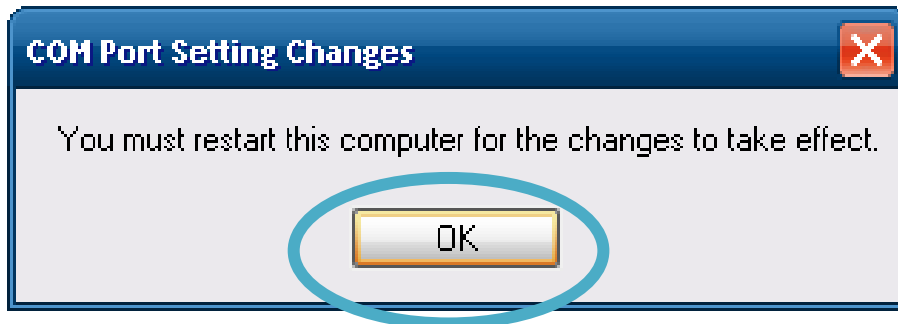

For XP-8x31-WES7:

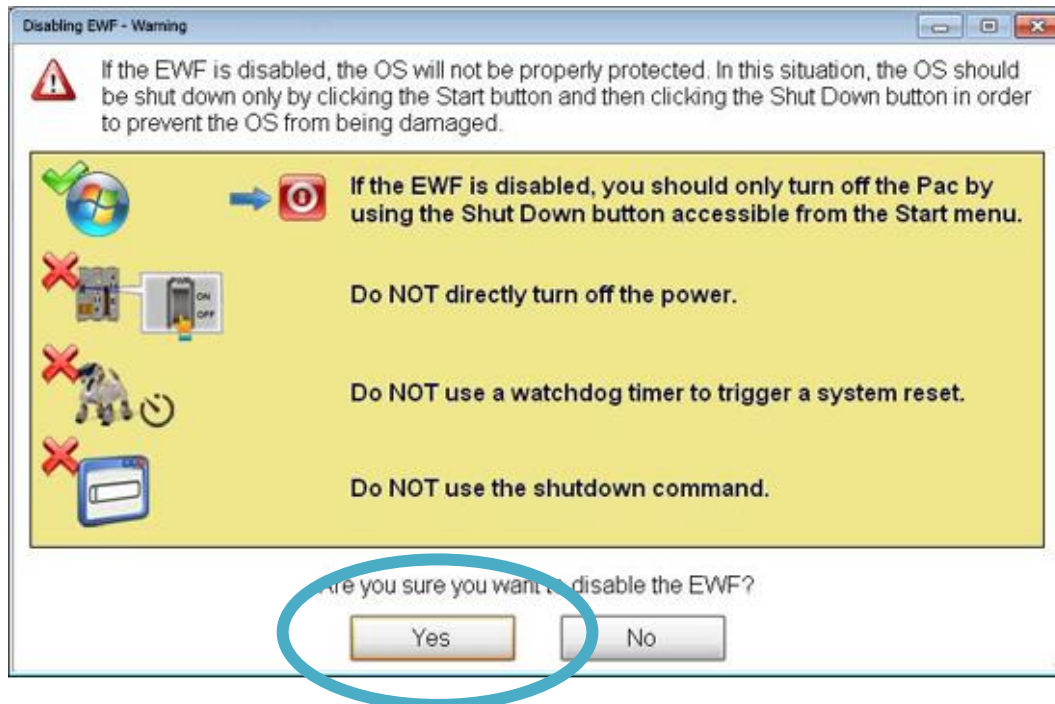

4) Reboot the XP-8000

3.4.2. Enabling the EWF

PAC Utility allows users to easily configure EWF features.

- 1) Run the **PAC Utility**
- 2) Click the **EWF Operation**, select the **Disable**, and then click **Apply**

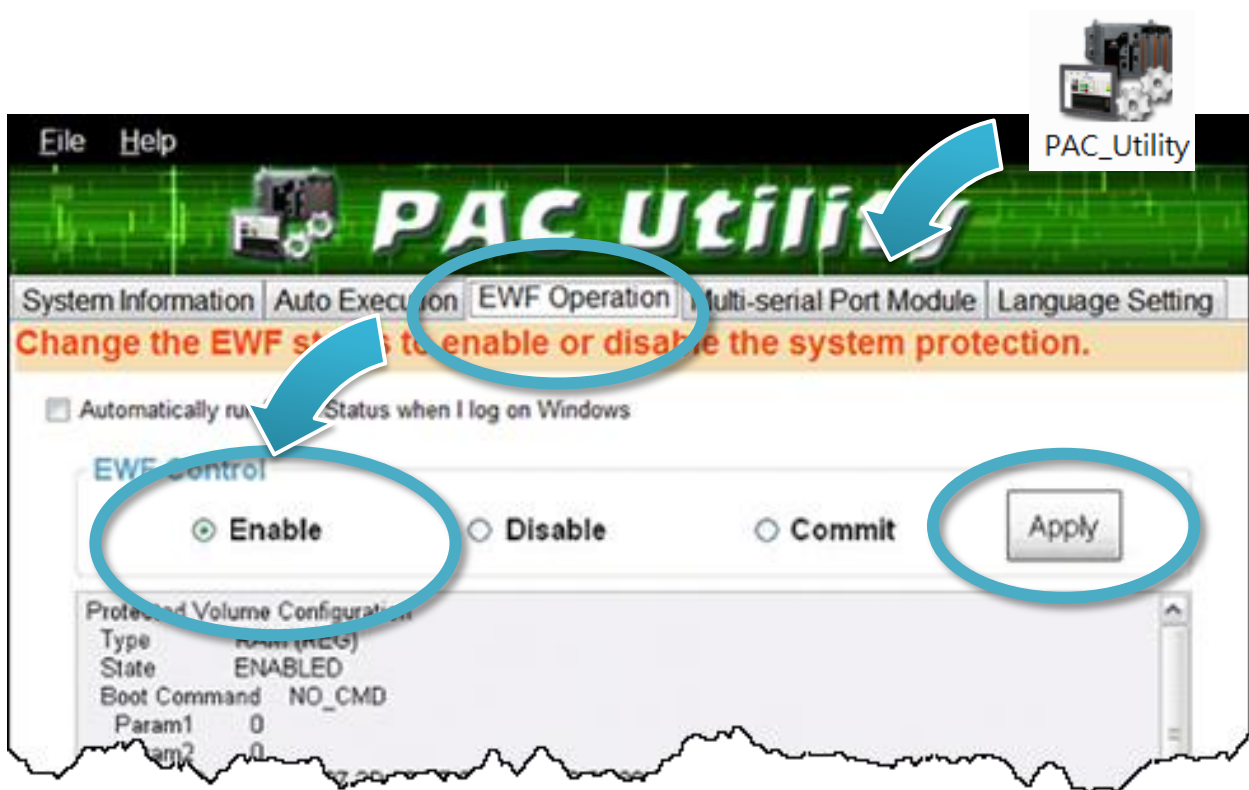

Tips & Warnings



EWF only takes effect on hard drive C (where the operating system resides), it is recommended to download your programs to Compact Flash or USB-HDD. It'll prevent operating system from damages of illegal writing or sudden power off.

3) Click **OK/Yes** to save changes to the disk

For XP-8x41 and XP-8x41-Atom:

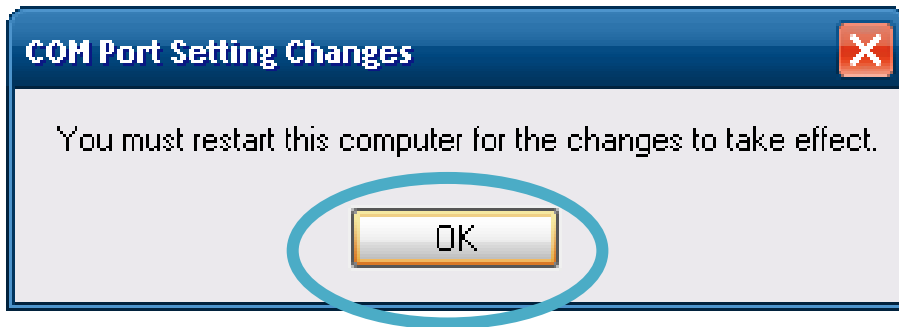

For XP-8x31-WES7:

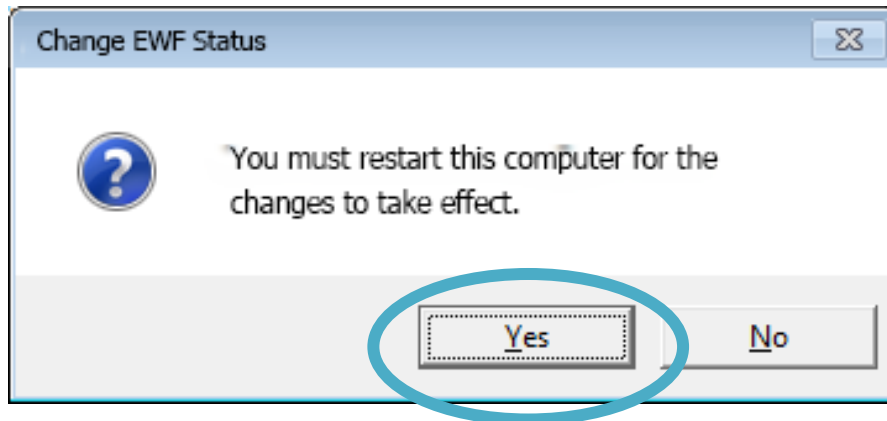

4) Reboot the XP-8000

3.4.3. Using the EWF Manager commands

EWF Manager (EWFMgr) is a console application that provides a command-line interface for managing EWF.

In these cases you have to enter the command in the command line window.

Funtion	Command
Enable write protection of drive C:	ewfmgr c: -enable
Disable write protection of drive C: (changed data is applied)	ewfmgr c: -commitanddisable
Apply changed data on drive C:	ewfmgr c: -commit
Display information about the EWF drive	ewfmgr c:
Display Help	ewfmgr /h

For more information about using EWF Manager Commands, please refer to Manager Commands [http://msdn.microsoft.com/en-us/library/ms940853\(v=WinEmbedded.5\).aspx](http://msdn.microsoft.com/en-us/library/ms940853(v=WinEmbedded.5).aspx)

4. Tools and Tasks

This chapter provides a brief introduction of the XP-8000 service tools and its benefits.

There are several tools and utilities built-in and designed for use with XP-8000. Some of these are pre-installed on XP-8000 and can work directly on XP-8000, and some of these are supporting tools and can help you to manage the XP-8000 remotely on a PC.

Tools for working with PC can be found separately on the CD that was provided with the package or by downloading the latest version from ICP DAS web site.

- For XP-8x31-WES7:

CD:\ippc-wes7\
ftp://ftp.icpdas.com/pub/cd/ippc-wes7/

▪ For XP-8x41:

CD:\XP-8000\
http://ftp.icpdas.com/pub/cd/xp-8000/

- For XP-8x41-Atom:

CD:\XPAC-Atom\
http://ftp.icpdas.com/pub/cd/xpac-atom/

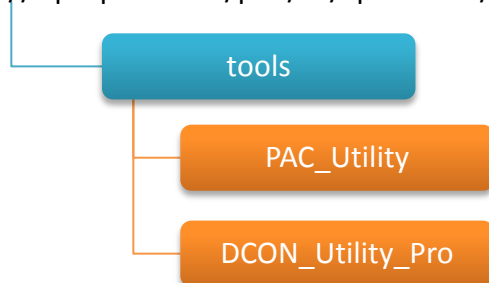

4.1. PAC Utility

PAC Utility is a collection of software applications that enable management and configuration of XP-8000 system and features.

4.1.1. System Information

The System Information tab provides functions to monitor necessary device information of XP-8000. The system information is the most important note of version control for upgrading system.

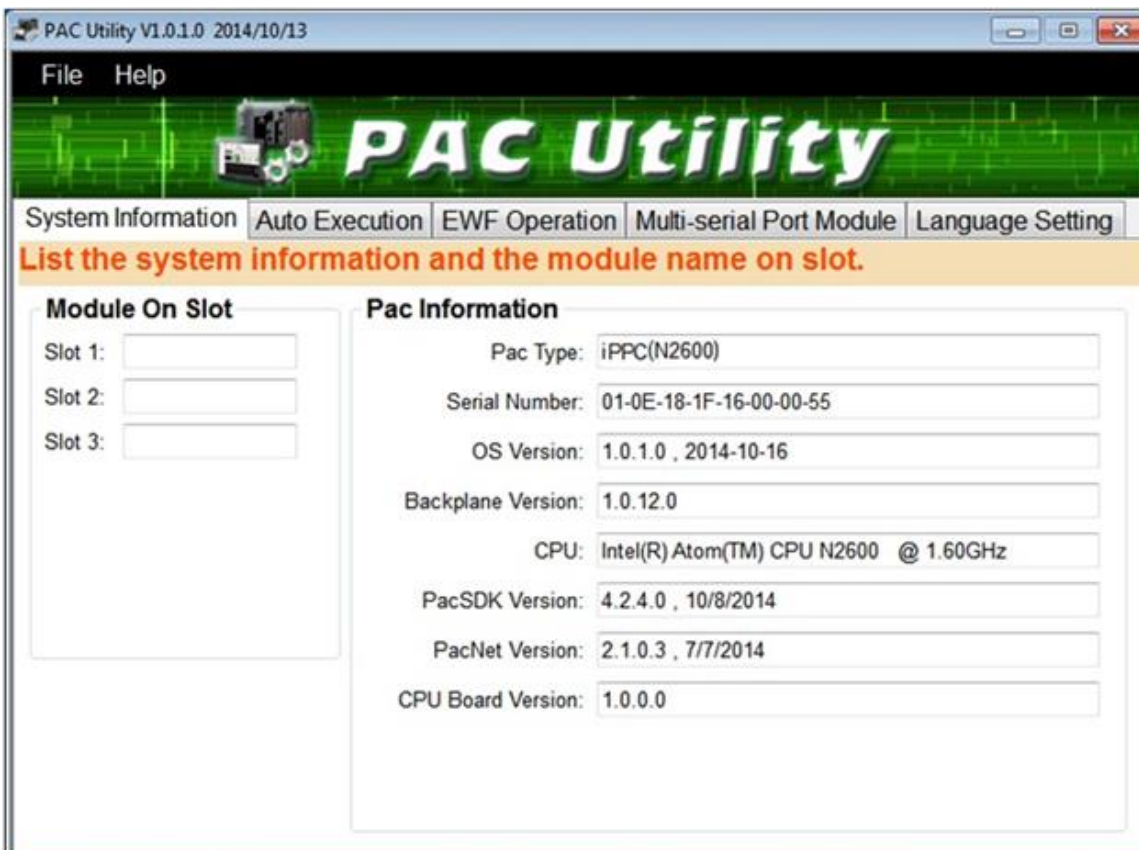

4.1.2. Auto Execution

The Auto Execution tab provides functions to configure programs running at XP-8000 startup, it allows users to configure ten execute files at most.

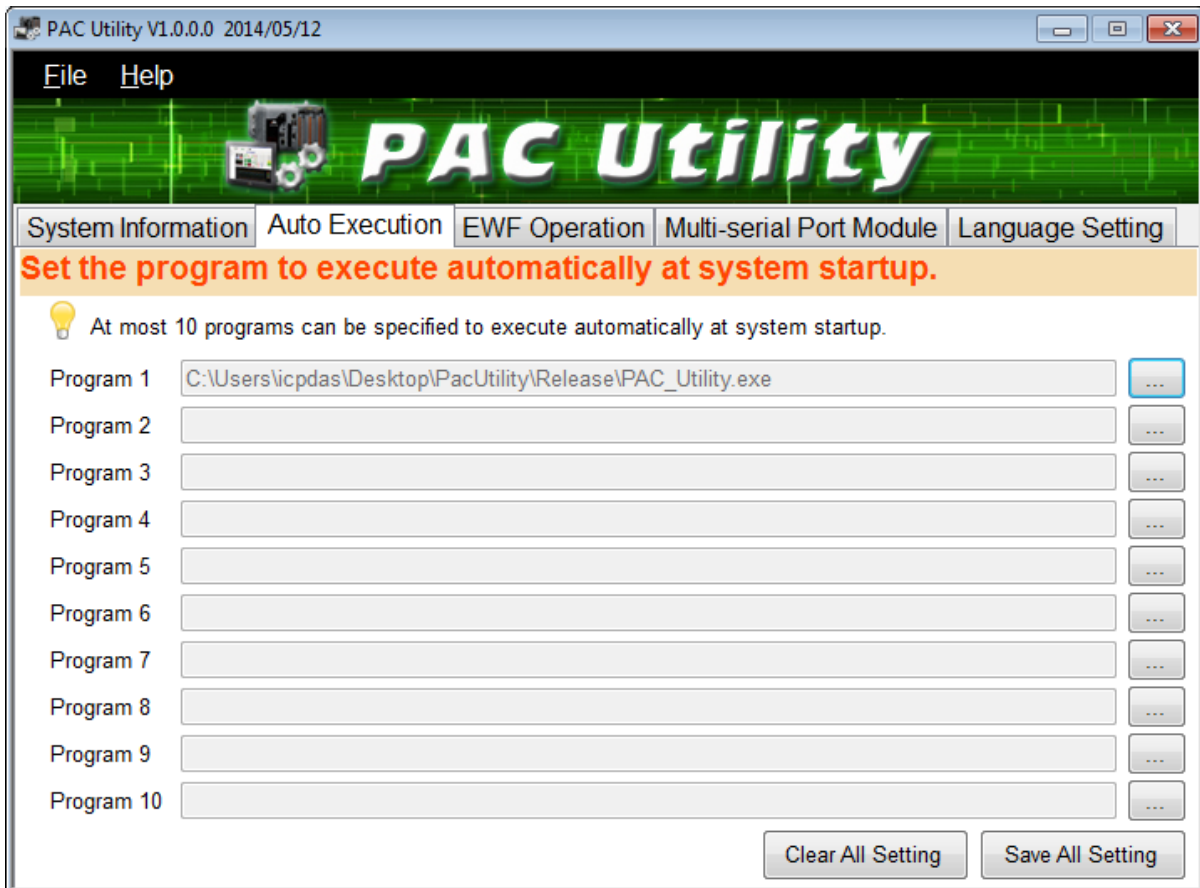

Tips & Warnings



The allowed file types are .exe and .bat, and they are executed in order of program 1, program 2, etc.

The tab use to	How to use
Configure programs running at startup	Click on the Browse button and select the execute file which you want, and then click the Save All Setting button.

4.1.3. EWF Operation

The EWF Operation tab provides functions to configure EWF.

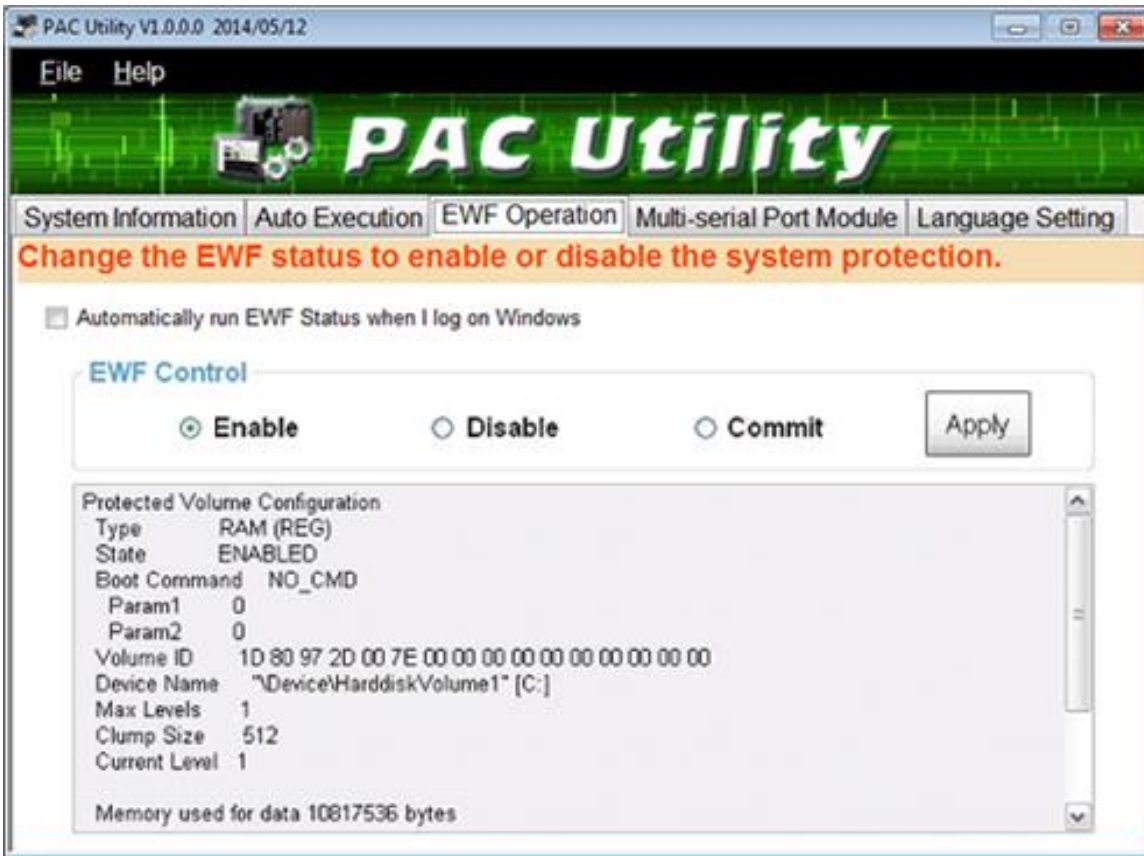

The tab use to	How to use
Enable/disable the EWF function	<p>Enable the EWF function: Select the Enable option, and then click the Apply button.</p> <p>Disable the EWF function: Select the Disable option, and then click the Apply button.</p>
Commit changes	Select the Commit option, and then click the Apply button.

4.1.4. Multi-serial Port Module



The Multi-serial port provides functions for installation of the RS-232/RS-422/RS-485 communication module driver.



The table below shows the expansion RS-232/RS-422/RS-485 communication modules that are compatible with the XP-8000.

I/O Module	RS-232	RS-422/RS-485	Isolation	Connector
I-8112iW	2	-	2500 Vrms	DB-9 x 2
I-8114W	4	-	-	DB-37 x 1
I-8114iW	4	-	2500 Vrms	DB-37 x 1
I-8142iW	-	2	2500 Vrms	Terminator block x 1
I-8144iW	-	4	2500 Vrms	Terminator block x 1

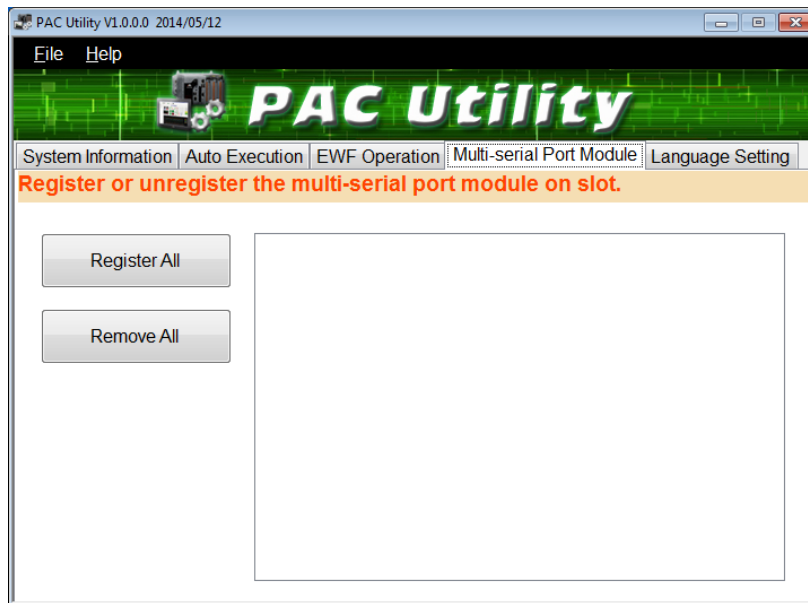

The XP-8000 can be expanded to support up to 16 I/O modules.

For more detailed information about these support modules, please refer to http://www.icpdas.com/products/Remote_IO/i-8ke/selection_rs232_i8k.htm

The tab use to	How to use
Register/remove the multi-serial port	<p>Register the multi-serial port: Click the Register All button.</p> <p>Remove the multi-serial port: Click the Remove All button.</p>

4.1.5. Language Setting

The Language Setting tab provides functions to change the user interface language.

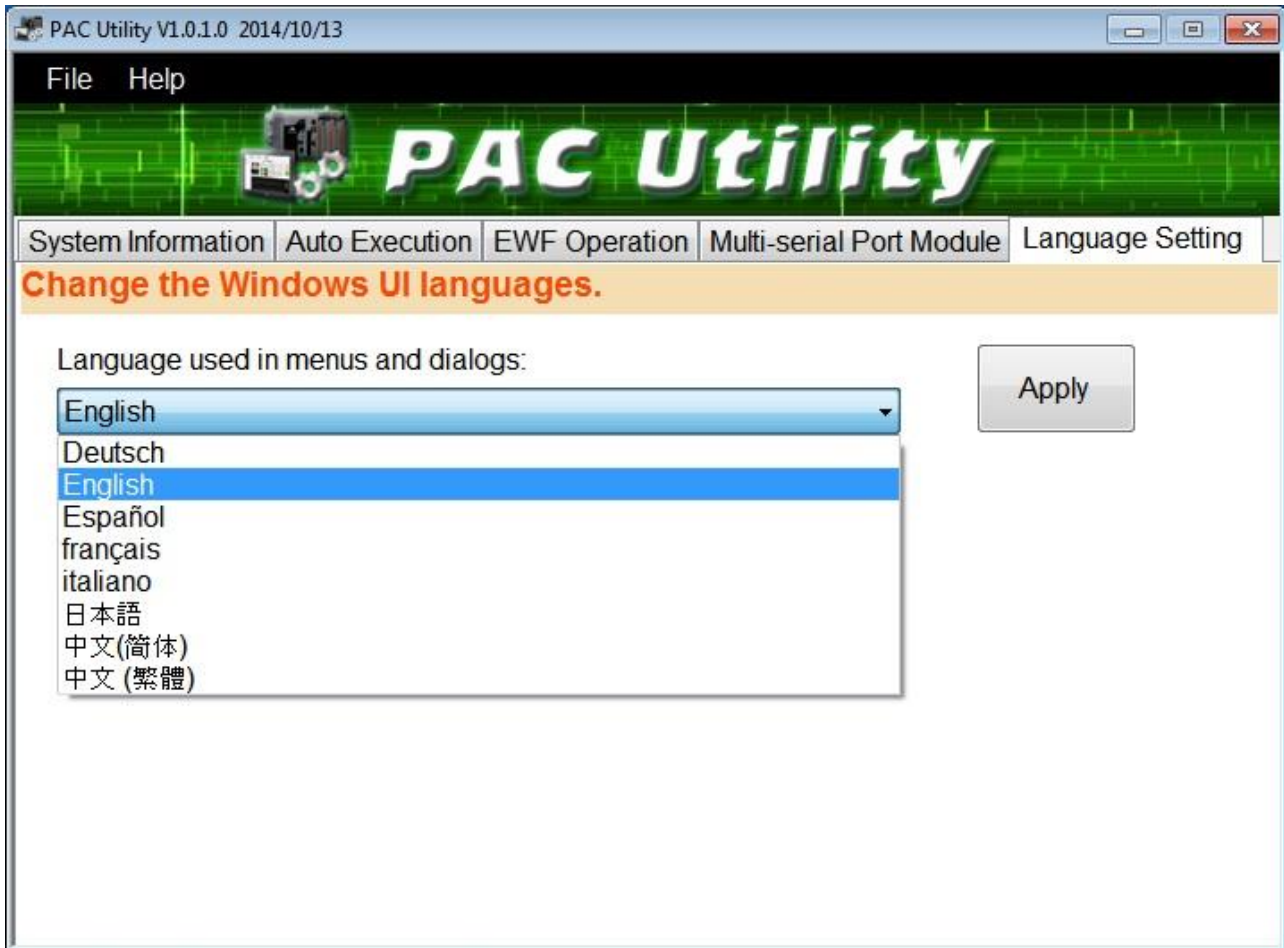

The tab use to	How to use
Change the user interface language	Click on the drop down arrow and select your preferred language, and then click the Apply button.

4.2. DCON Utility Pro

The DCON Utility Pro is a toolkit that help user to search the network, easily to configure and test the I/O modules via the serial port (RS-232/485) or Ethernet port (using virtual com port).

For more information on how to use DCON Utility Pro to configure I/O modules, please refer to section 2.6. Using DCON Utility Pro to Configure I/O Modules.

5. Your First XP-8000 Program

This chapter provides a guided tour that describes the steps needed to set-up a development environment, download, install, configure for user programming with XP-8000.

Before writing your first program, ensure that you have the necessary development tool and the corresponding SDKs are installed on your system.

Development Tools

XP-8000 has .NET Framework 3.5/4.5 installed. Visual Studio takes full advantage of the .NET Framework, which uses public Internet standards to enable integration with new and existing applications running on any platform.

Supported languages include

- Visual Basic.NET
- Visual C#
- Visual C++

XP-8000 SDK

The PAC SDK is a Software Development Kit (SDK) that contains C header files, C libraries and documents.

The XP-8000 SDK is classified by development tools that can be obtained from the CD that was provided with the package or by downloading the latest version from ICP DAS web site.

▪ **For XP-8x31-WES7:**

<http://ftp.icpdas.com/pub/cd/ippc-wes7/sdk/pacsdk/>

▪ **For XP-8x41:**

<http://ftp.icpdas.com/pub/cd/xp-8000/sdk/pacsdk/>

▪ **For XP-8x41-Atom:**

<http://ftp.icpdas.com/pub/cd/xpac-atom/sdk/pacsdk/>

5.1. First XP-8000 Program in VB.NET

The best way to learn programming with XP-8000 is to actually create a XP-8000 program.

The example below demonstrates how to create a demo program running on XP-8000 with VB.NET.

To create a demo program with VB.NET that includes the following main steps:

1. Create a new project
2. Specify the path of the PAC reference
3. Add the control to the form
4. Add the event handling for the control
5. Upload the application to XP-8000
6. Execute the application on XP-8000

All main steps will be described in the following subsection.

5.1.1. Create a new project

The Visual VB.net project template is a composite control that you use in this example creates a new project with this user control.

Step 1: Start Visual Studio 2008



Step 2: On the File menu, point to New, and then click Project

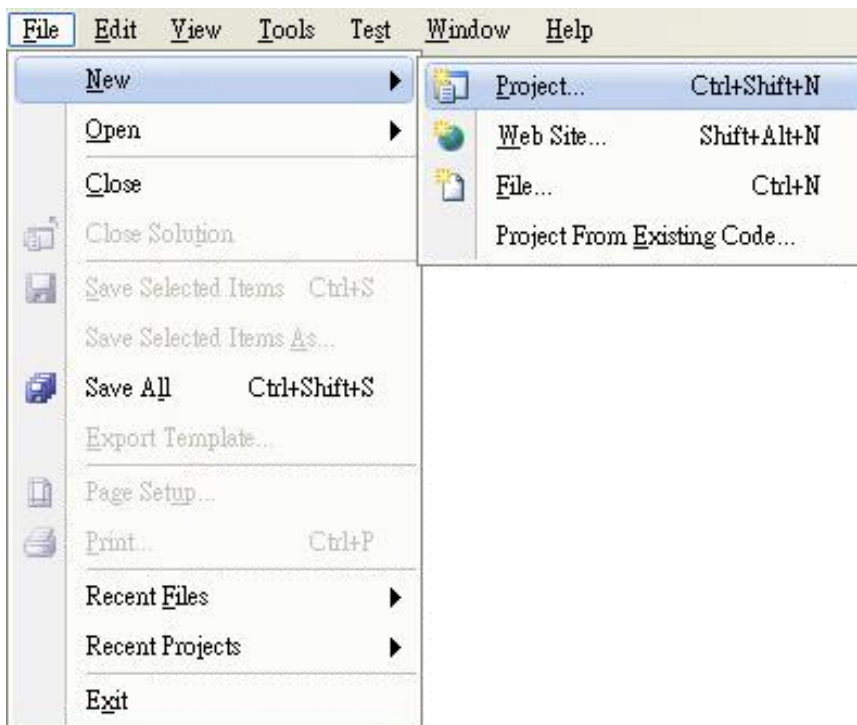

Step 3: In the Project types pane, expand Visual Basic node and select Windows

Step 4: In the list of Templates, select Windows Forms Application

Step 5: Specify a name and a location for the application and then click OK

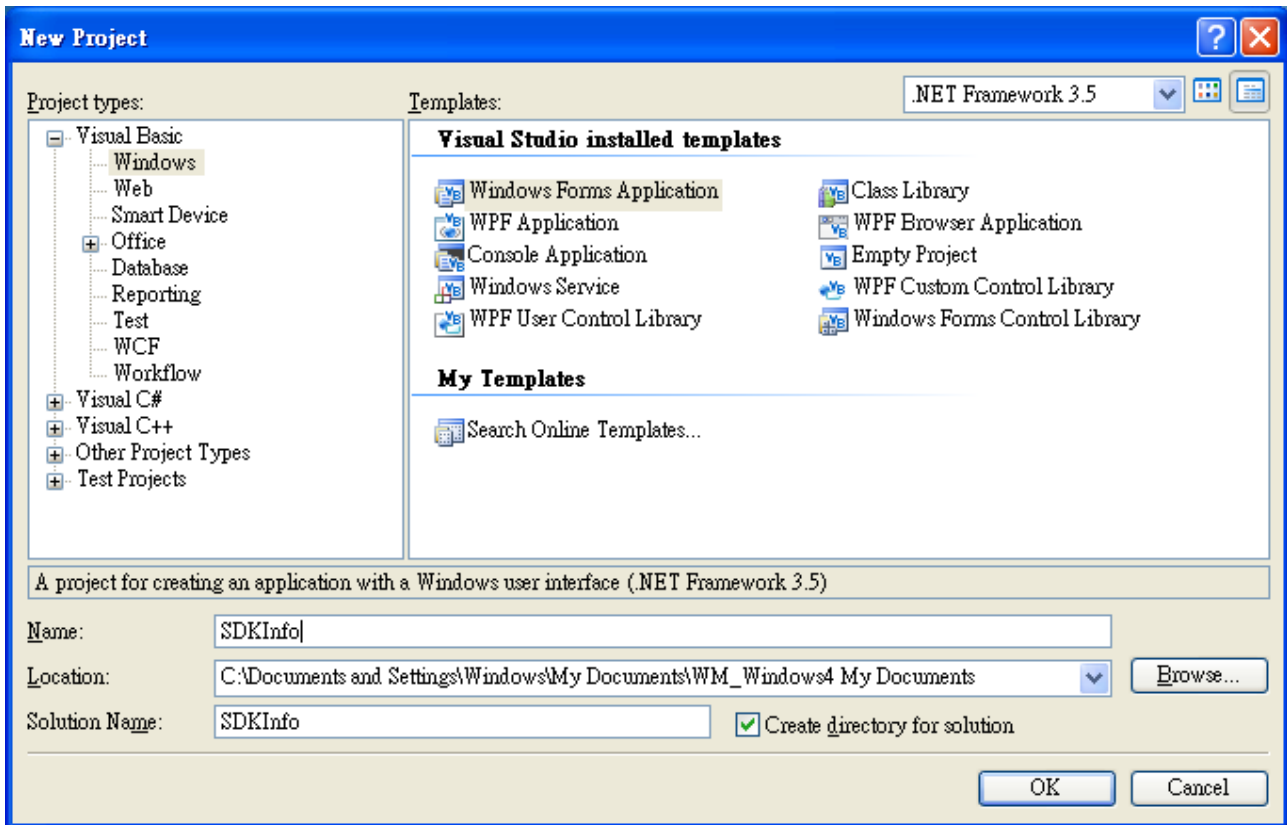

5.1.2. Specify the path of the PAC reference

The PAC SDK provides a complete solution to integrate with XP-8000 and it's compatible with Visual C#, Visual Basic .net and C++. In order to use a component in your application, you must first add a reference to it.

Step1: Get the PACNET.dll



The PACNET.dll can be found from the CD that was provided with the package or by downloading the latest version from ICP DAS web site.

- **For XP-8x31-WES7:**

CD:\ippc-wes7\sdk\pacsdk\pacnet\
<http://ftp.icpdas.com/pub/cd/ippc-wes7/sdk/pacsdk/pacnet/>

- **For XP-8x41:**

CD:\XP-8000\SDK\pacsdk\pacnet\
<http://ftp.icpdas.com/pub/cd/xp-8000/sdk/pacsdk/pacnet/>

- **For XP-8x41-Atom:**

CD:\XPAC-ATOM\SDK\packsdk\packnet\
<http://ftp.icpdas.com/pub/cd/xpac-atom/sdk/pacsdk/pacnet/>

Step 2: In the Solution Explorer, right-click the References node, and then click Add Reference...

Step 3: On the Browse tab and browse to where the PACNET.dll are installed, and then click OK

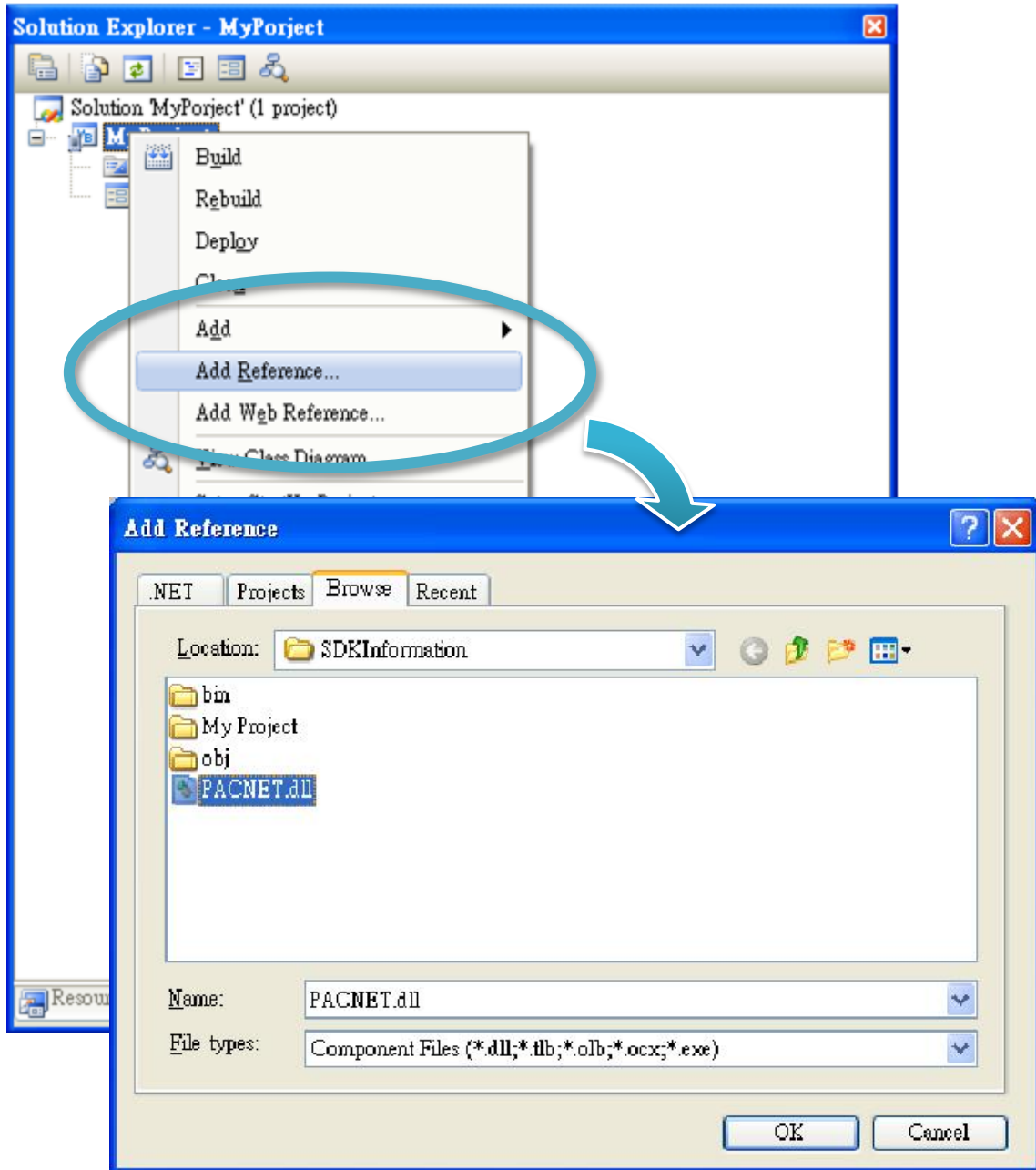

5.1.3. Add the control to the form

You can drag various controls from the Toolbox onto the form. These controls are not really "live"; they are just images that are convenient to move around on the form into a precise location.

After you add a control to your form, you can use the Properties window to set its properties, such as background color and default text. The values that you specify in the Properties window are the initial values that will be assigned to that property when the control is created at run time.

Step 1: On the Toolbox panel, drag a Button control onto the form

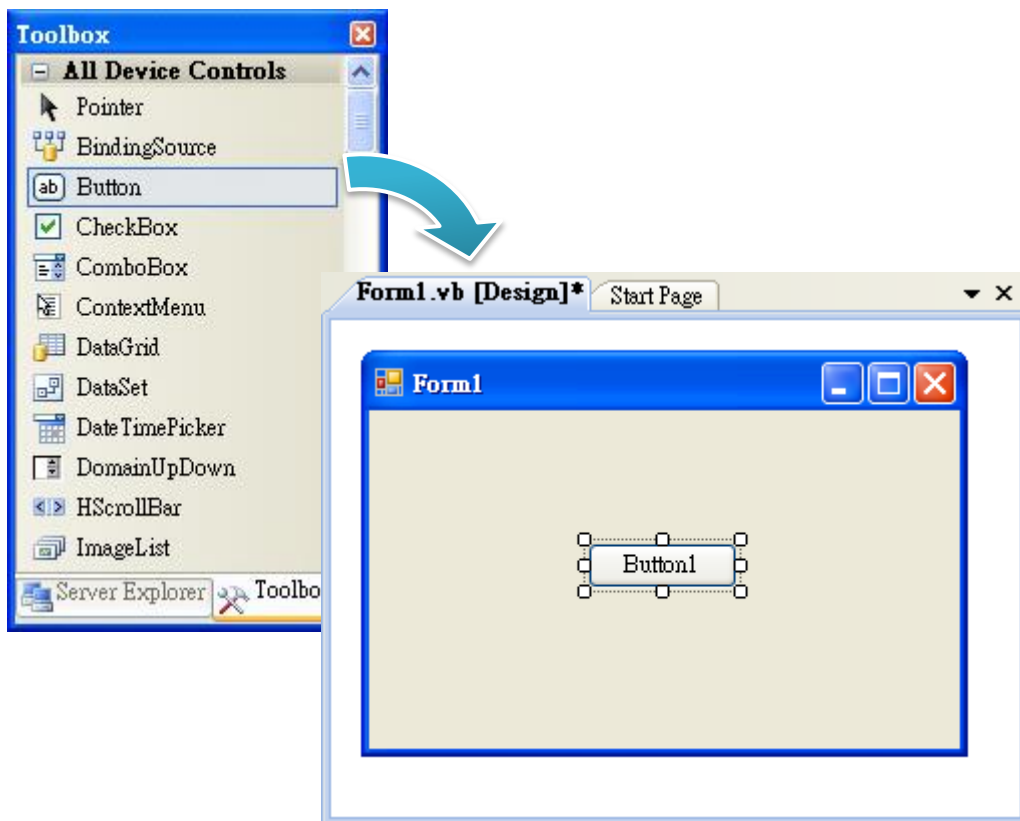

Step 2: On the Properties panel, type Check the SDK version in the Text field

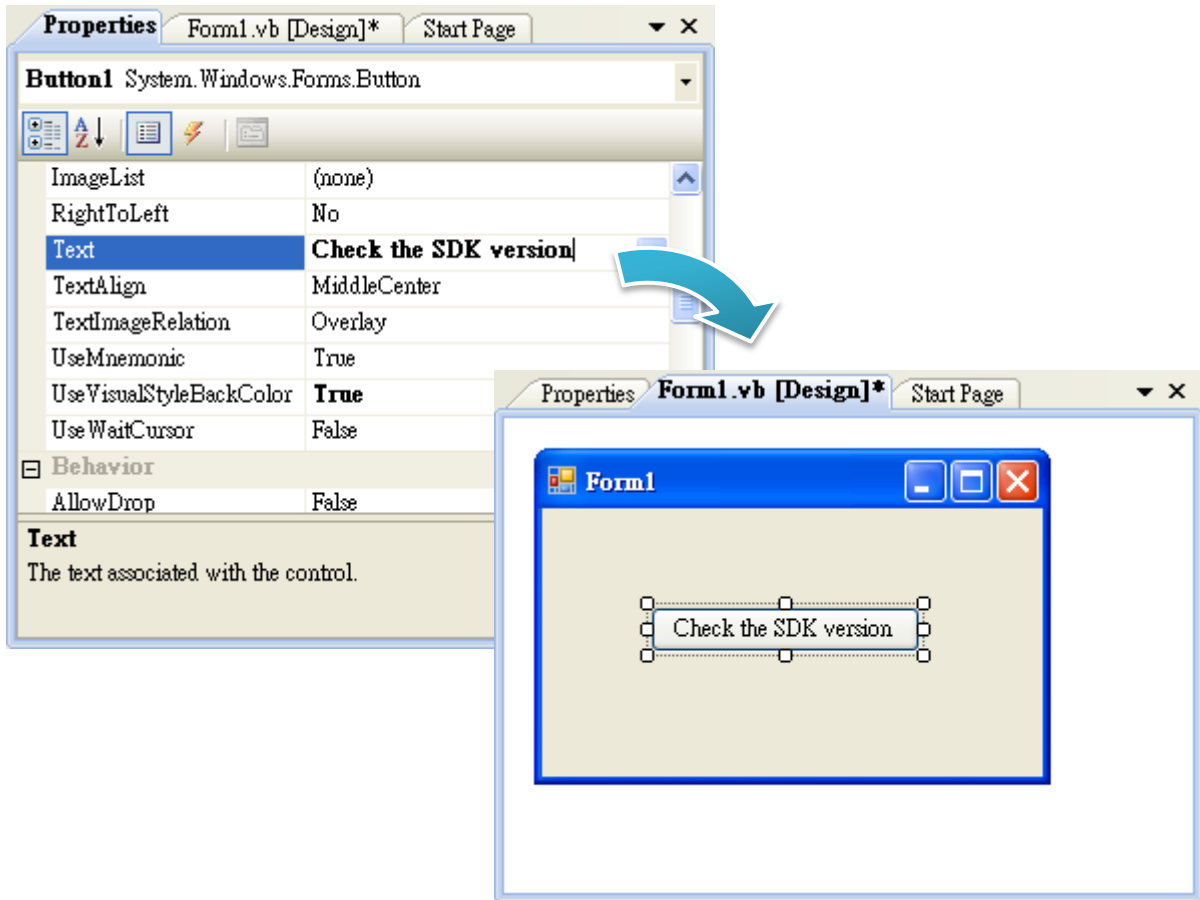

5.1.4. Add the event handling for the control

You have finished the design stage of your application and are at the point when you can start adding some code to provide the program's functionality.

Step 1: Double-click the button on the form

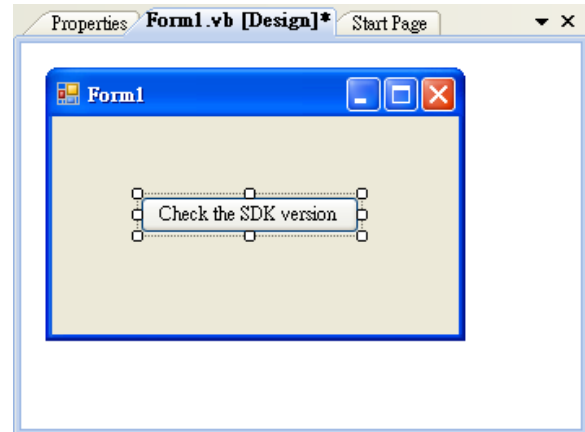

Step 2: Inserting the following code

```
Dim data(30) As Byte
PACNET.Sys.GetSDKVersion(data)
MessageBox.Show(PACNET.MISC.WideString(data))
```

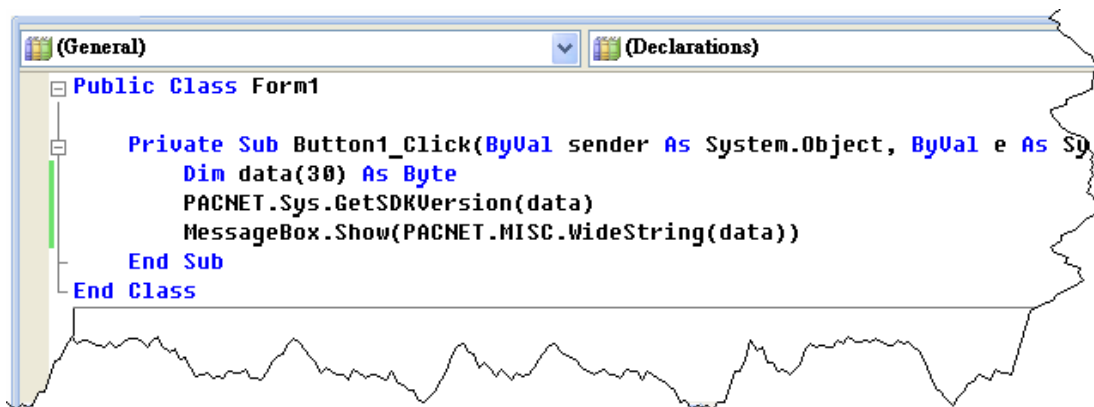

Tips & Warnings



The "PACNET" of "using PACNET" is case-sensitive.

5.1.5. Upload the application to XP-8000

XP-8000 supports FTP server service. You can upload files to XP-8000 or download files from a public FTP server.

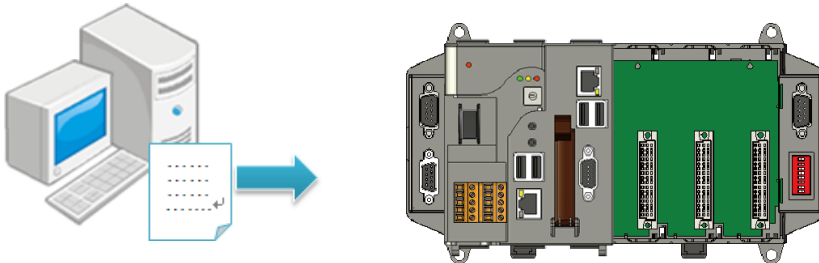

Step 1: On the Build menu, and then click Build Solution

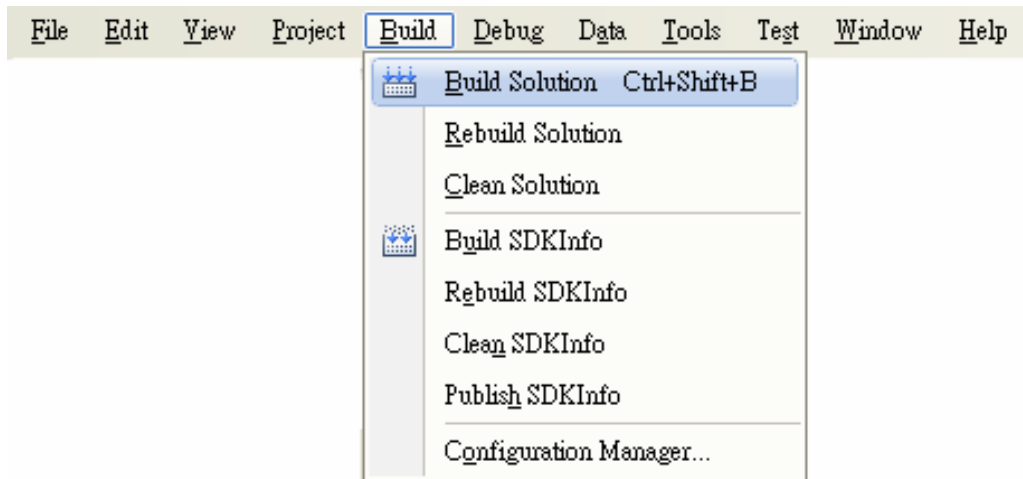

Step 2: Open the browser and type the IP address of XP-8000

Step 3: Upload the application and the corresponding PACNET.dll files to XP-8000

Tips & Warnings



For applications programming in C# and VB.net with .net compact framework, when executing these application on XP-8000, the corresponding PACNET.dll must be in the same directory as the .exe file.

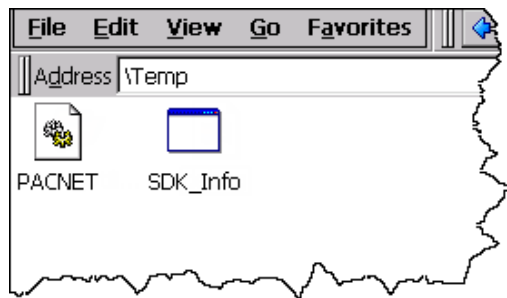

5.1.6. Execute the application on XP-8000

After uploading the application to XP-8000, you can just double-click it on XP-8000 to execute it.

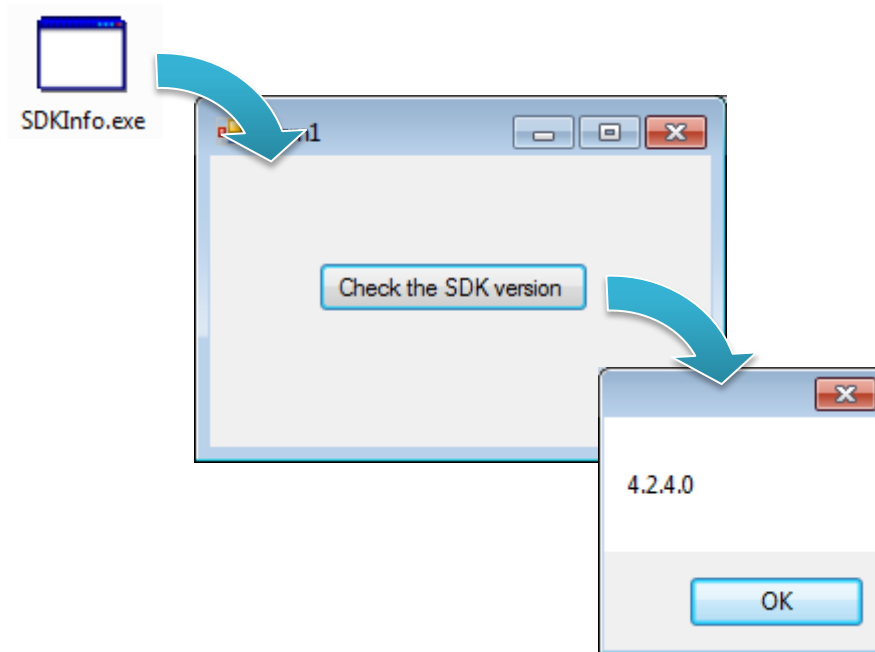

5.2. First XP-8000 Program in Visual C#

The best way to learn programming with XP-8000 is to actually create a XP-8000 program.

The example below demonstrates how to create a demo program running on XP-8000 with Visual C#.

To create a demo program with Visual C# that includes the following main steps:

1. Create a new project
2. Specify the path of the PAC reference
3. Add the control to the form
4. Add the event handling for the control
5. Upload the application to XP-8000
6. Execute the application on XP-8000

All main steps will be described in the following subsection.

5.2.1. Create a new project

The Visual VB.net project template is a composite control that you use in this example creates a new project with this user control.

Step 1: Start Visual Studio 2008



Step 2: On the File menu, point to New, and then click Project

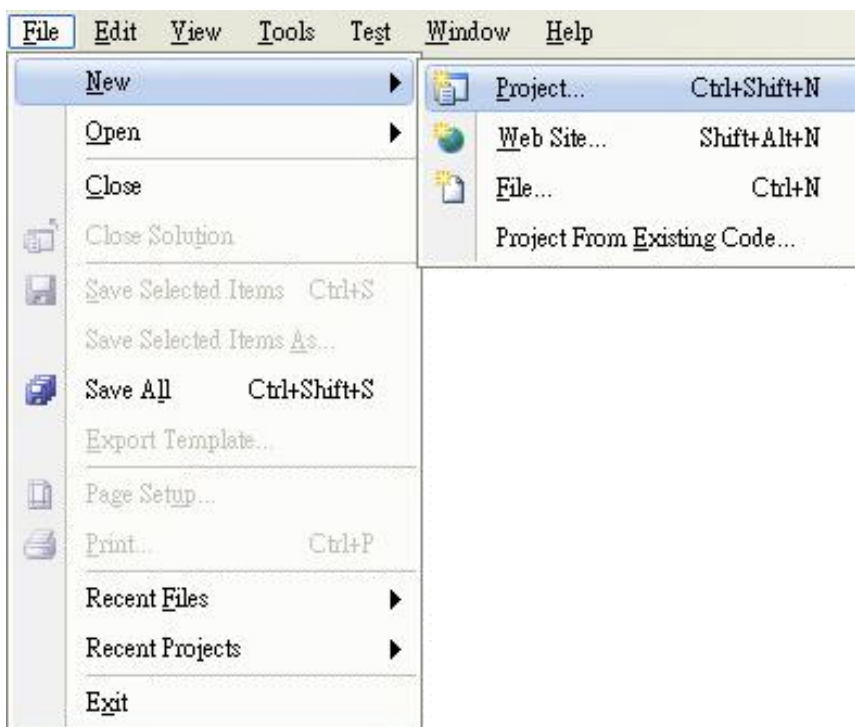

Step 3: In the Project types pane, expand Visual C# node and select Windows

Step 4: In the list of Templates, select Windows Forms Application

Step 5: Specify a name and a location for the application and then click OK

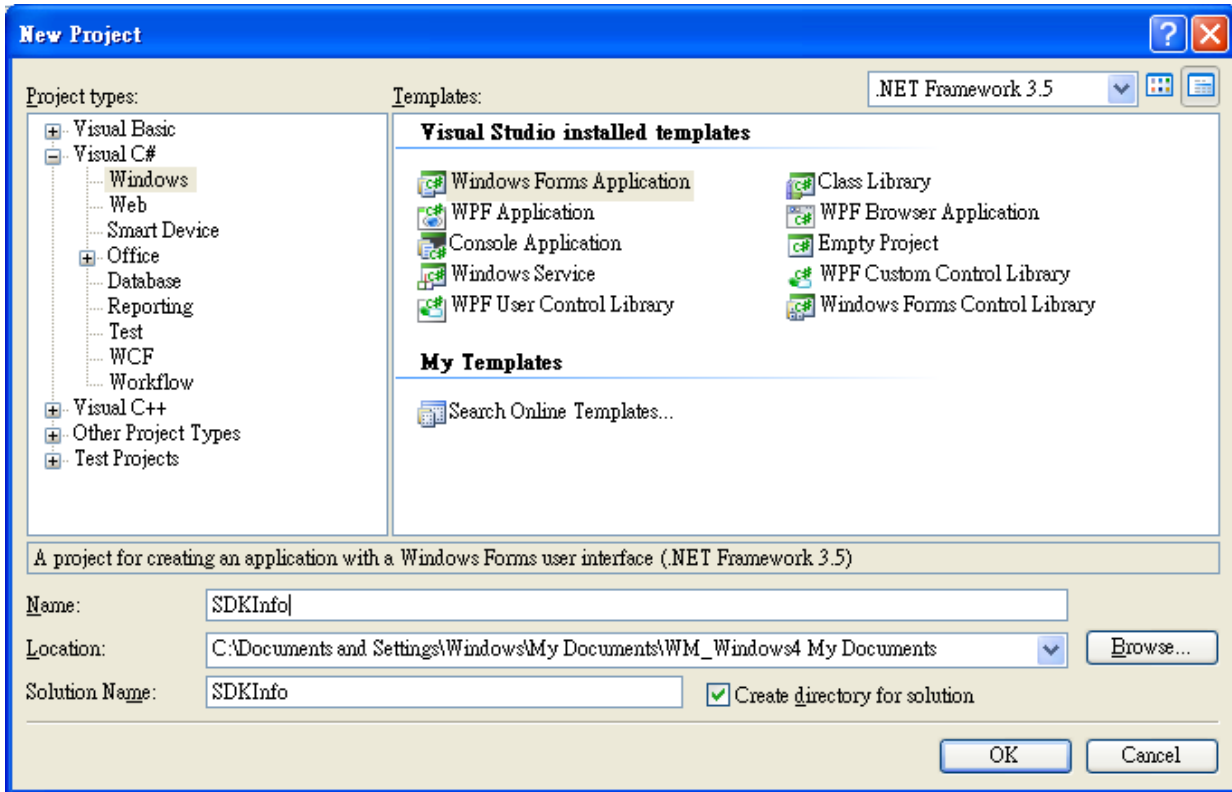

5.2.2. Specify the path of the PAC reference

The PAC SDK provides a complete solution to integrate with XP-8000 and it's compatible with Visual C#, Visual Basic .net and C++. In order to use a component in your application, you must first add a reference to it.

Step1: Get the PACNET.dll



The PACNET.dll can be found from the CD that was provided with the package or by downloading the latest version from ICP DAS web site.

- **For XP-8x31-WES7:**

CD:\ippc-wes7\sdk\pacsdk\pacnet\
<http://ftp.icpdas.com/pub/cd/ippc-wes7/sdk/pacsdk/pacnet/>

- **For XP-8x41:**

CD:\XP-8000\SDK\pacsdk\pacnet\
<http://ftp.icpdas.com/pub/cd/xp-8000/sdk/pacsdk/pacnet/>

- **For XP-8x41-Atom:**

CD:\XPAC-ATOM\SDK\packsdk\packnet\
<http://ftp.icpdas.com/pub/cd/xpac-atom/sdk/pacsdk/pacnet/>

Step 2: In the Solution Explorer, right-click the References node, and then click Add Reference...

Step 3: On the Browse tab and browse to where the PACNET.dll are installed, and then click OK

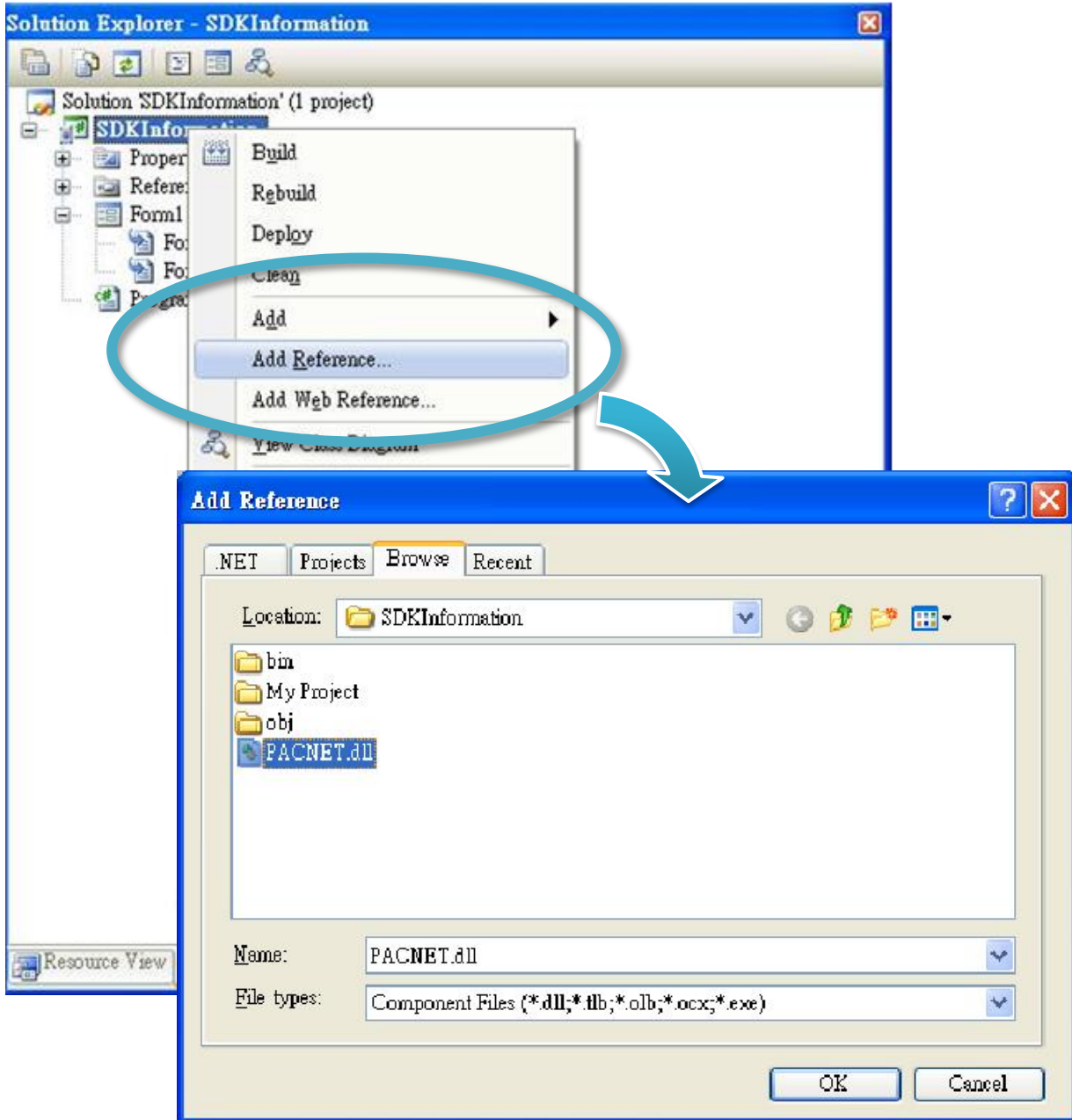

5.2.3. Add the control to the form

You can drag various controls from the Toolbox onto the form. These controls are not really "live"; they are just images that are convenient to move around on the form into a precise location.

After you add a control to your form, you can use the Properties window to set its properties, such as background color and default text. The values that you specify in the Properties window are the initial values that will be assigned to that property when the control is created at run time.

Step 1: On the Toolbox panel, drag a Button control onto the form

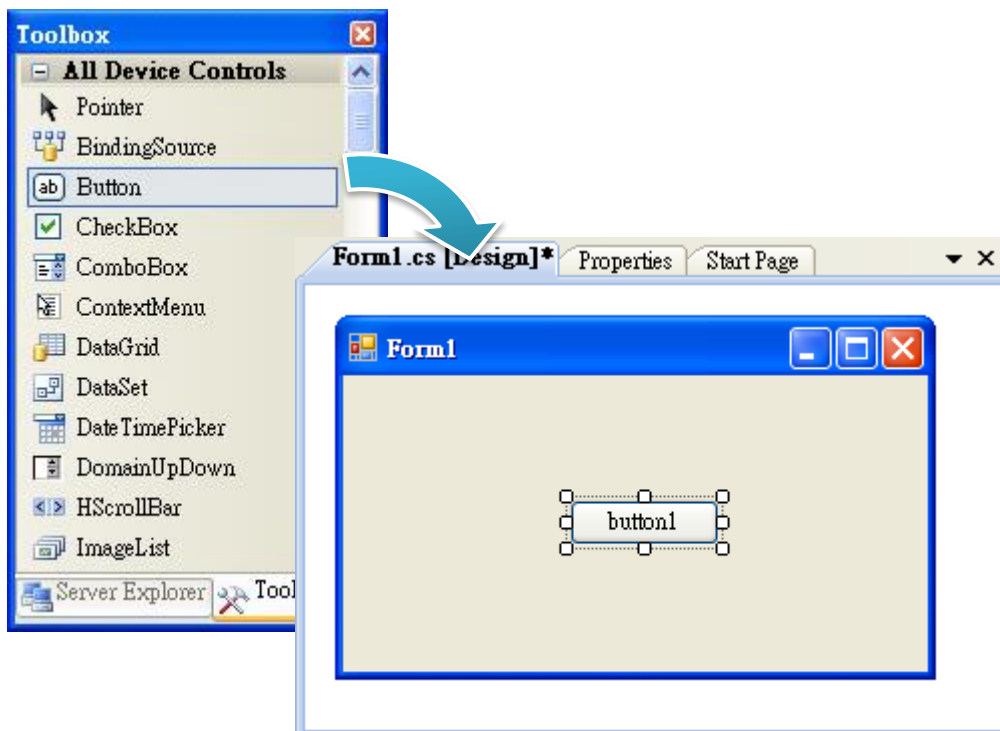

Step 2: On the Properties panel, type Check the SDK version in the Text field

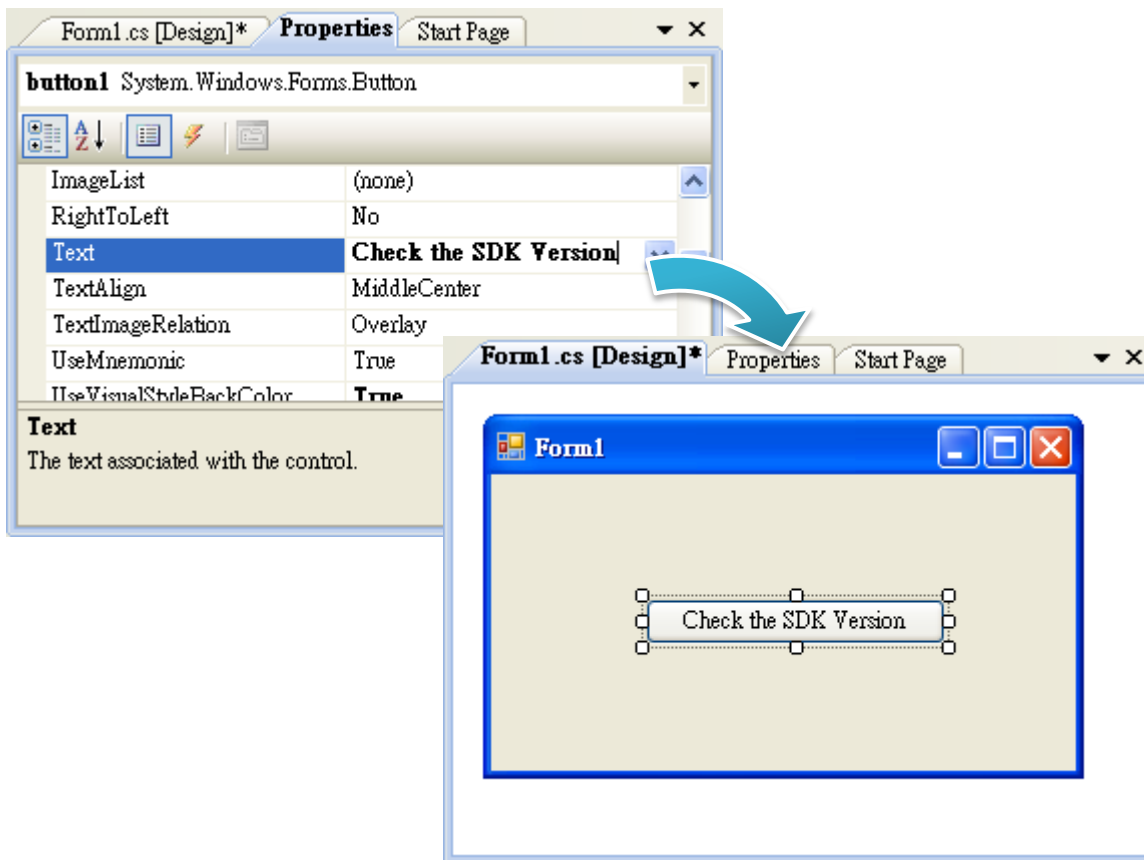

5.2.4. Add the event handling for the control

You have finished the design stage of your application and are at the point when you can start adding some code to provide the program's functionality.

Step 1: Double-click the button on the form

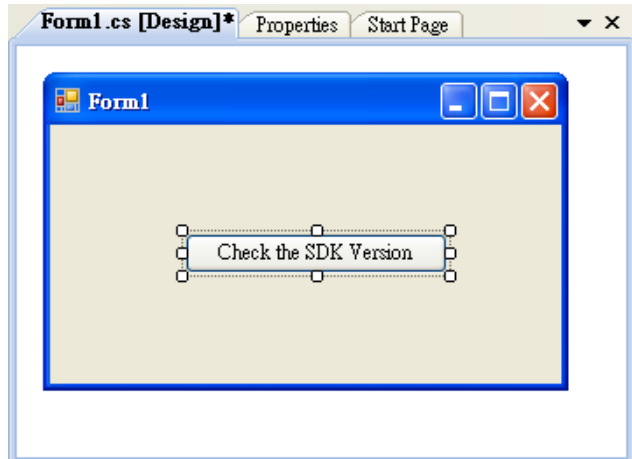

Step 2: Inserting the following code

```
byte[] data = new byte[30];  
PACNET.Sys.GetSDKVersion(data);  
MessageBox.Show(PACNET.MISC.WideString(data));
```

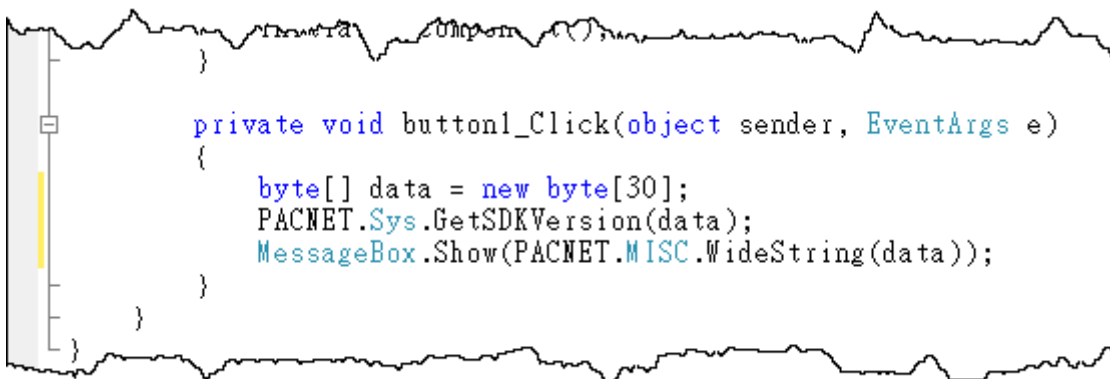

Tips & Warnings



The “PACNET” of “using PACNET” is case- sensitive.

5.2.5. Upload the application to XP-8000

XP-8000 supports FTP server service. You can upload files to XP-8000 or download files from a public FTP server.

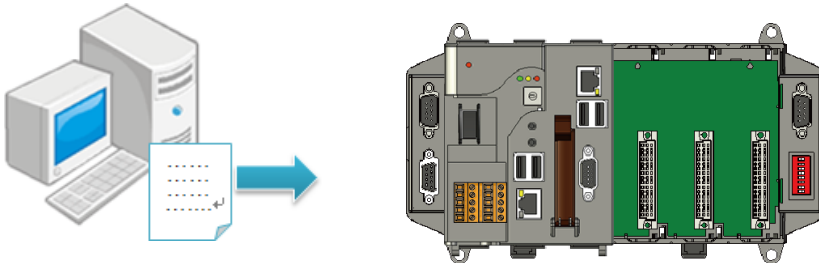

Step 1: On the Build menu, and then click Build Solution

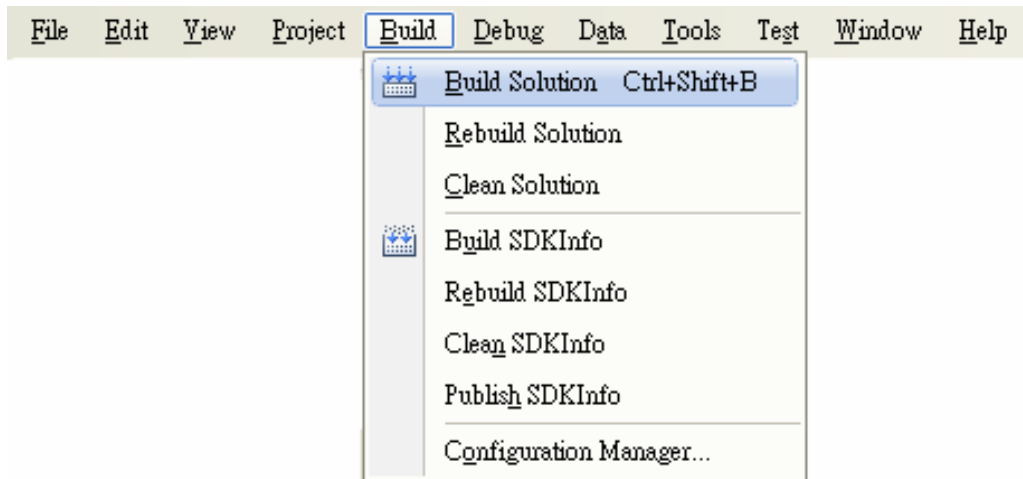

Step 2: Open the browser and type the IP address of XP-8000

Step 3: Upload the application and the corresponding PACNET.dll files to XP-8000

Tips & Warnings



For applications programming in C# and VB.net with .net compact framework, when executing these application on XP-8000, the corresponding PACNET.dll must be in the same directory as the .exe file.

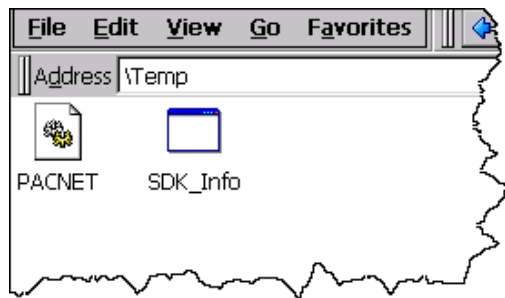

5.2.6. Execute the application on XP-8000

After uploading the application to XP-8000, you can just double-click it on XP-8000 to execute it.

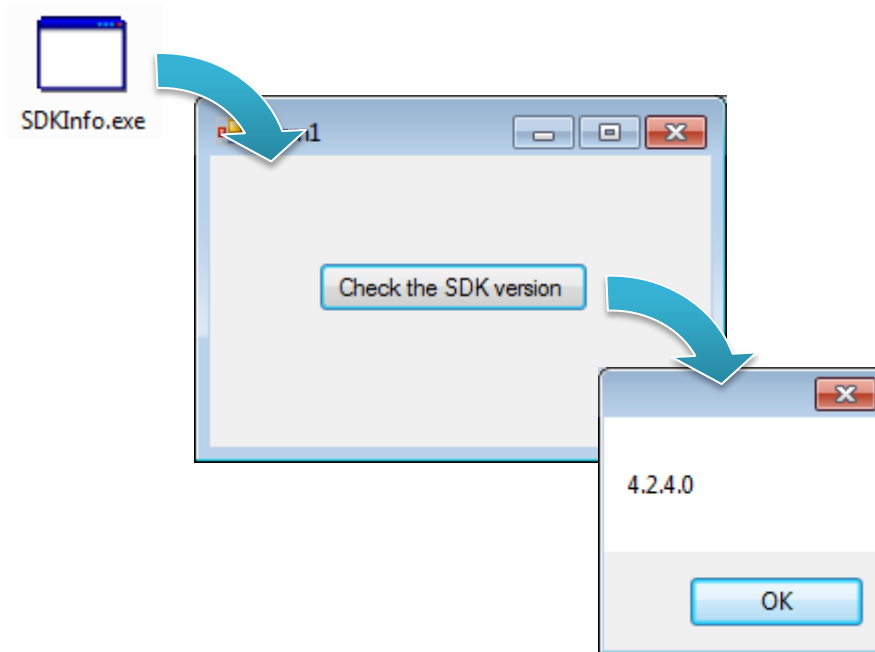

5.3. First XP-8000 Program in Visual C++

The best way to learn programming with XP-8000 is to actually create a XP-8000 program.

The example below demonstrates how to create a demo program running on XP-8000 with Visual C++.

To create a demo program with Visual C# that includes the following main steps:

1. Create a new project
2. Specify the path of the PAC reference
3. Add the control to the form
4. Add the event handling for the control
5. Upload the application to XP-8000
6. Execute the application on XP-8000

All main steps will be described in the following subsection.

5.3.1. Create a new project

The Visual C# project template is a composite control that you use in this example creates a new project with this user control.

Step 1: Start Visual Studio 2008



Step 2: On the File menu, point to New, and then click Project

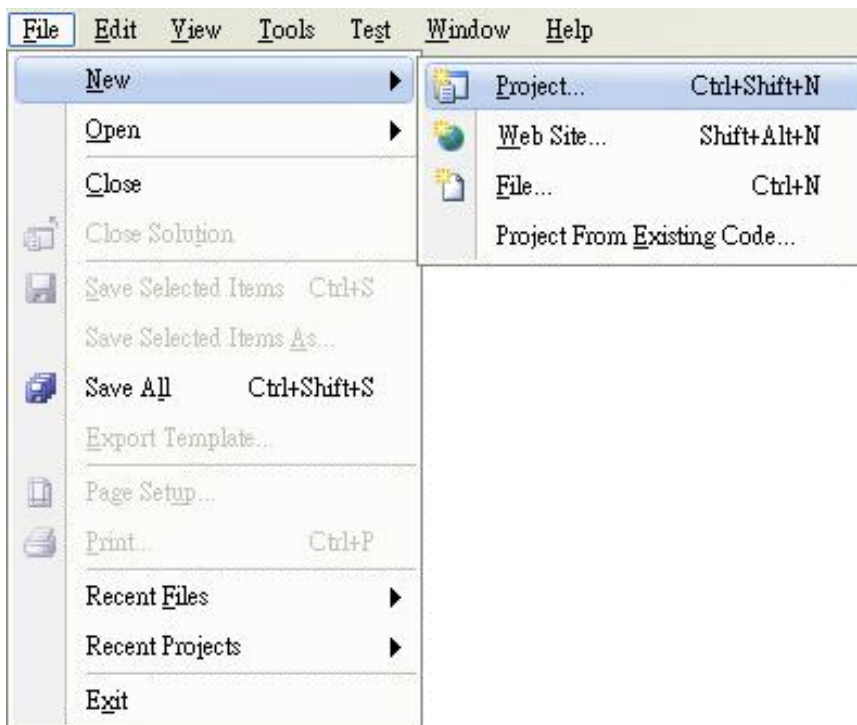

Step 3: In the Project types pane, expand Visual C++ node and select MFC

Step 4: In the list of Templates, select MFC Application

Step 5: Specify a name and a location for the application and then click OK

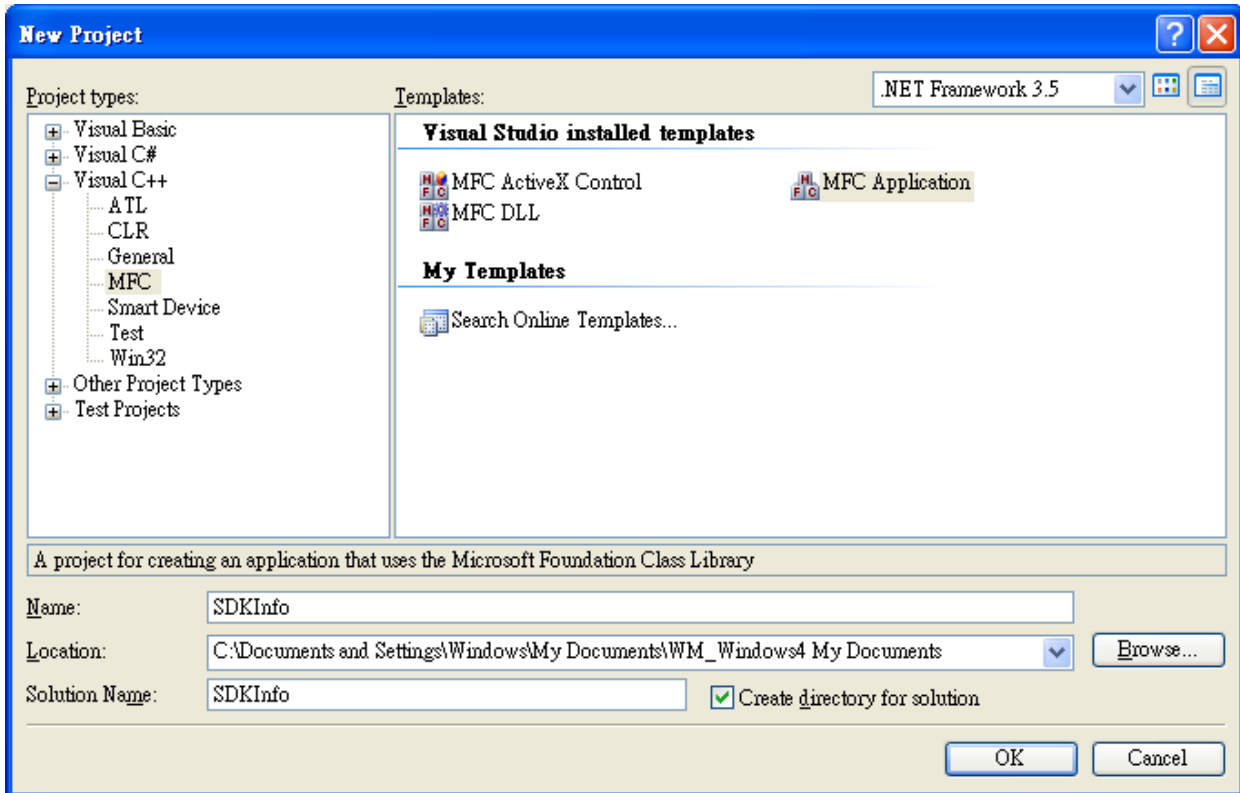

Step 6: On the first page of the wizard, click Next>

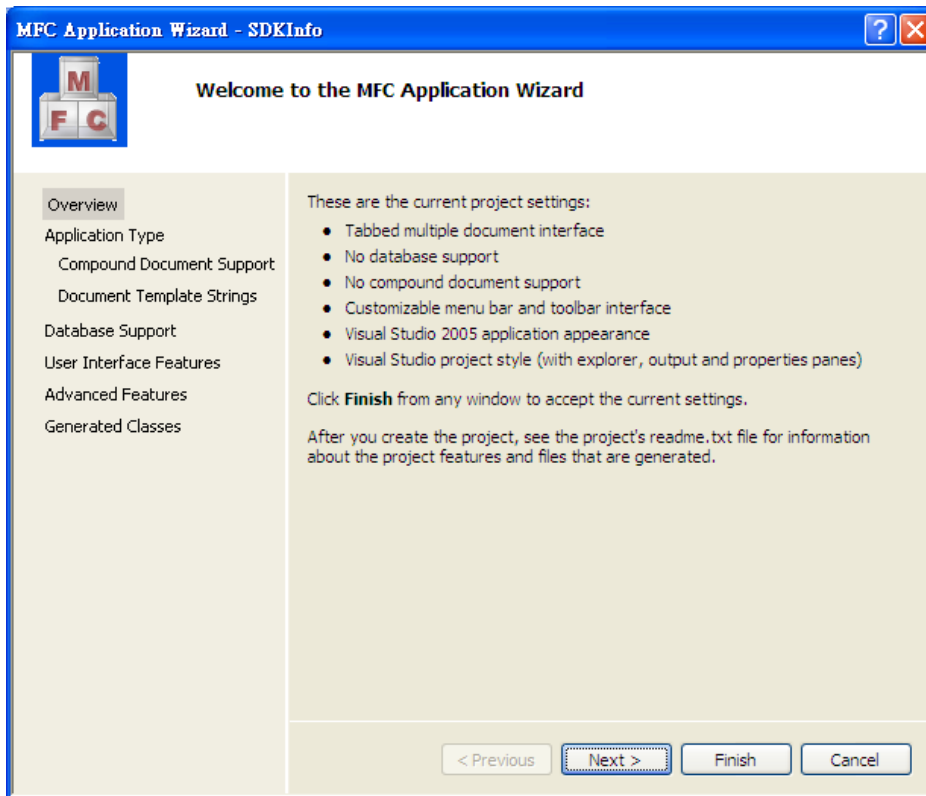

Step 7: On the next page of the wizard, select Dialog based, select Use MFC in a static library, and then click Finish

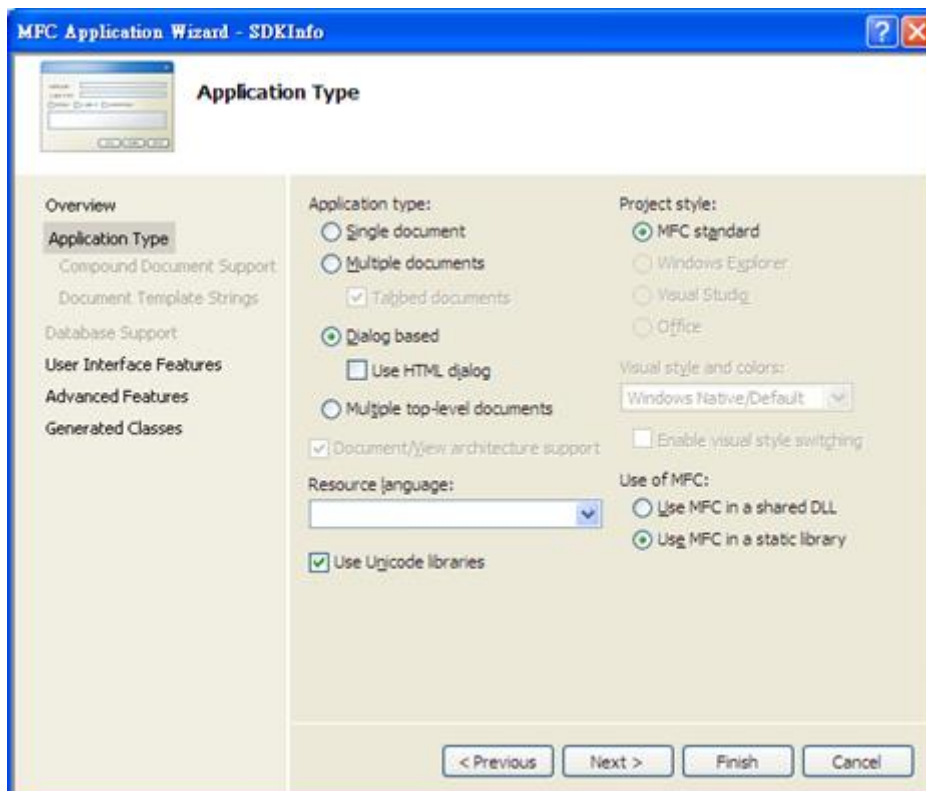

5.3.2. Specify the path of the PAC reference

The PAC SDK provides a complete solution to integrate with XP-8000 and it's compatible with Visual C#, Visual Basic .net and C++. In order to use a component in your application, you must first add a reference to it.

Step1: Get the PACSDK.H and PACSDK.lib

The PACSDK.H and PACSDK.lib can be found from the CD that was provided with the package or by downloading the latest version from ICP DAS web site.

- **For XP-8x31-WES7:**

CD:\ippc-wes7\sdk\pacsdk\pacsdk\

<http://ftp.icpdas.com/pub/cd/ippc-wes7/sdk/pacsdk/pacsdk/>

- **For XP-8x41:**

CD:\XP-8000\SDK\pacsdk\pacsdk\

<http://ftp.icpdas.com/pub/cd/xp-8000/sdk/pacsdk/pacsdk/>

- **For XP-8x41-Atom:**

CD:\XPAC-ATOM\SDK\packsdk\packsdk\

<http://ftp.icpdas.com/pub/cd/xpac-atom/sdk/pacsdk/pacsdk/>

Step 2: On the Tools menu, and then click Options

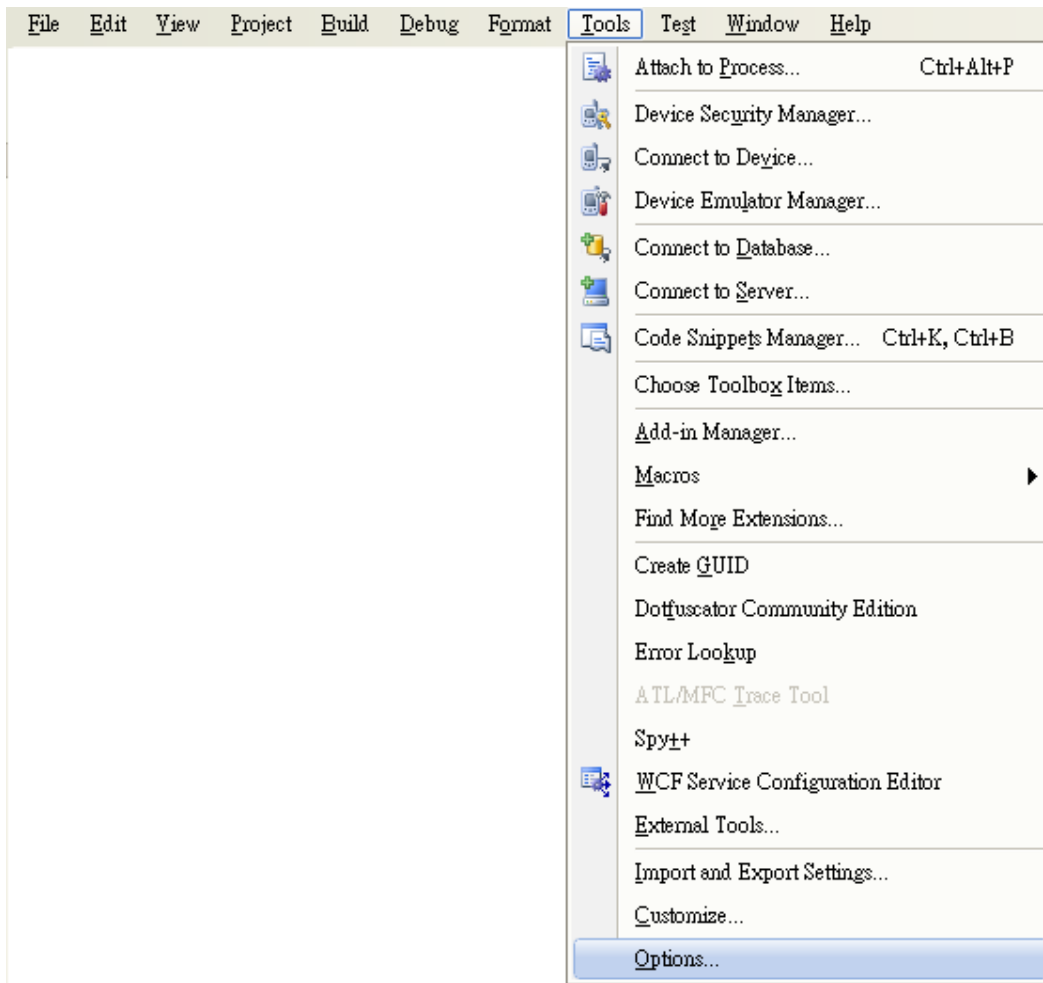

Step 3: In the left pane, expand Projects and Solutions, and then click the VC++ Directories

Step 4: Select Include files in the Show directories for drop down box, and then click the New Line button

Step 5: Add a new line to the list of directories. Browse to the directory that contains the PACSDK.H file.

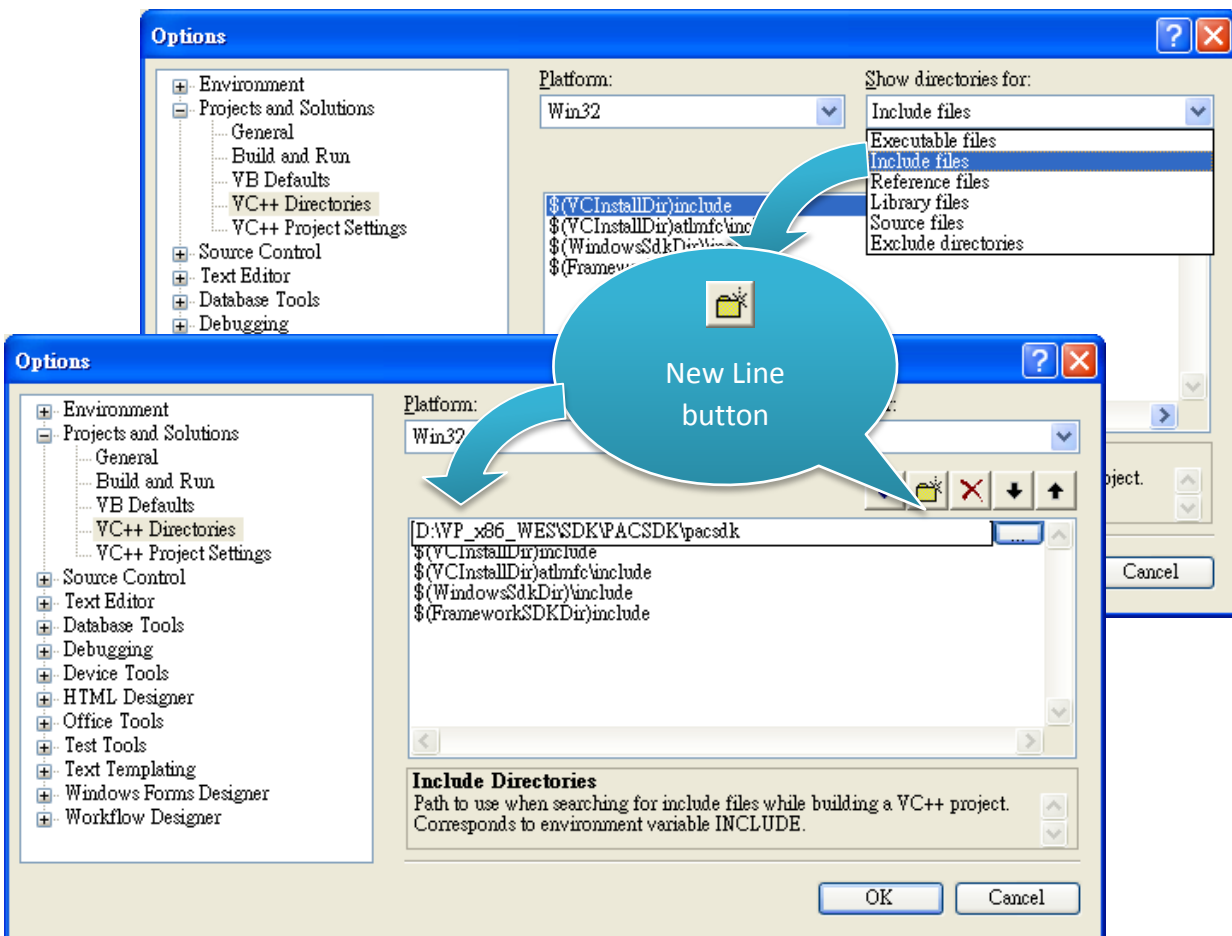

Step 6: Select Library files in the Show directories for drop down box, and then click the New Line button

Step 7: Add a new line to the list of directories. Browse to the directory that contains the PACSDK.lib file, and then click OK button

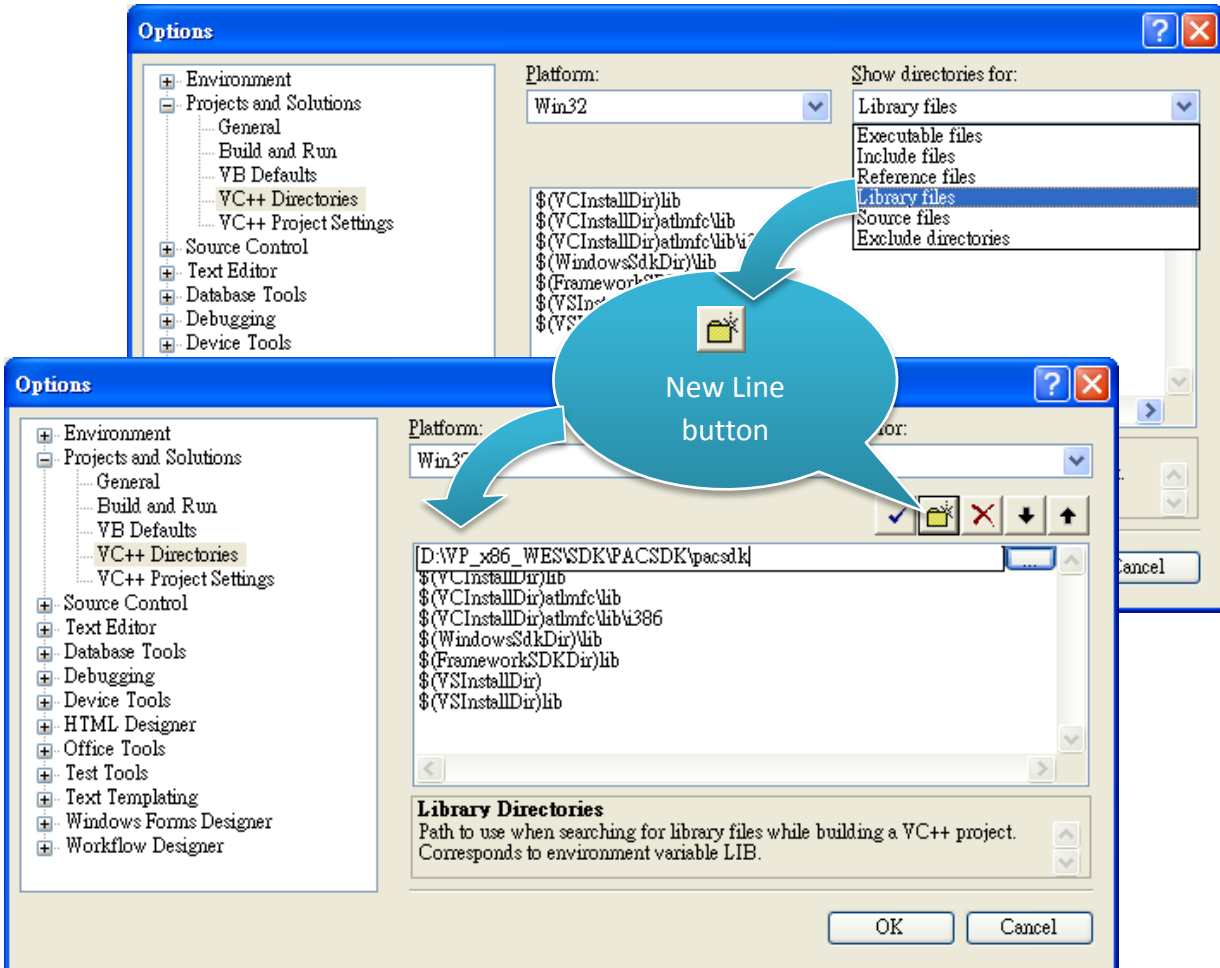

Step 8: In the Solution Explorer windows, right-click the project name, and then click Properties

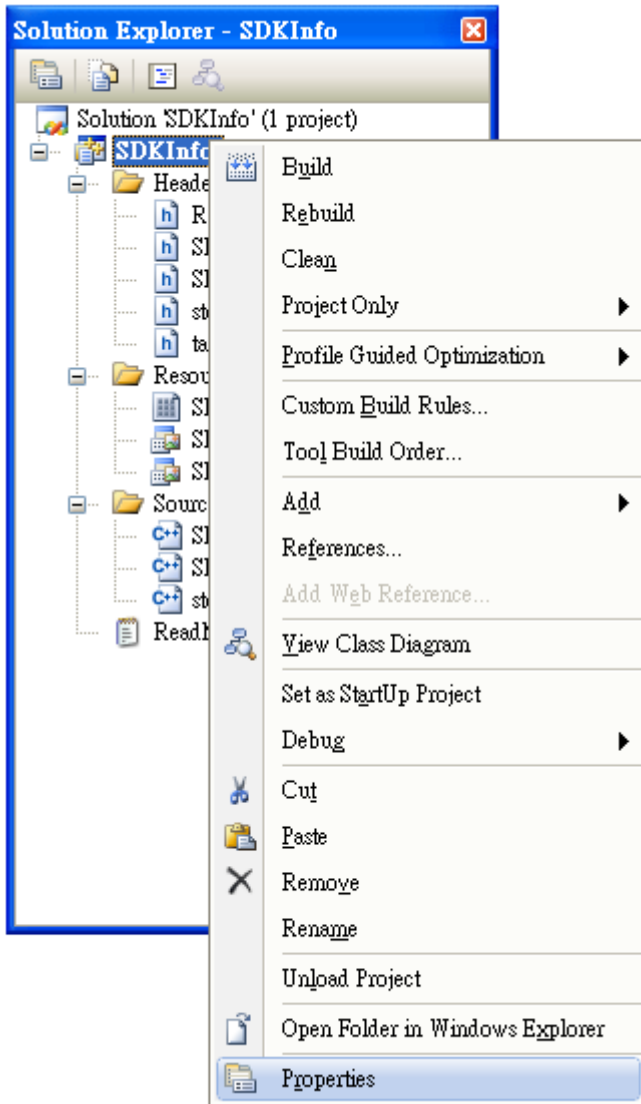

Step 9: In the left pane, expand **Configuration Properties**, and then click the **Link**

Step 10: In the right pane, type the **PACSDK.lib** in the **Additional Dependencies** item, click **Apply** button, and then click the **OK** button

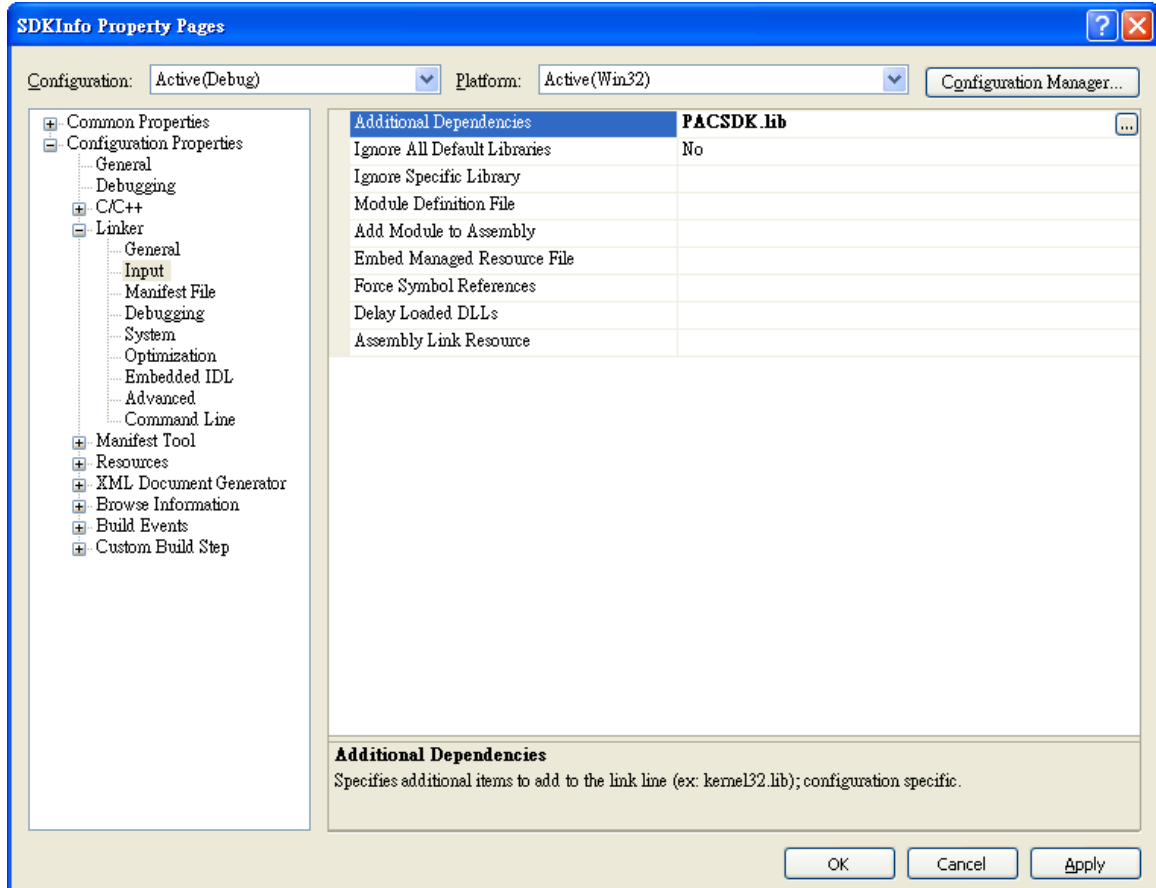

5.3.3. Add the control to the form

You can drag various controls from the Toolbox onto the form. These controls are not really "live"; they are just images that are convenient to move around on the form into a precise location.

After you add a control to your form, you can use the Properties window to set its properties, such as background color and default text. The values that you specify in the Properties window are the initial values that will be assigned to that property when the control is created at run time.

Step 1: On the Toolbox panel, drag a Button control onto the form

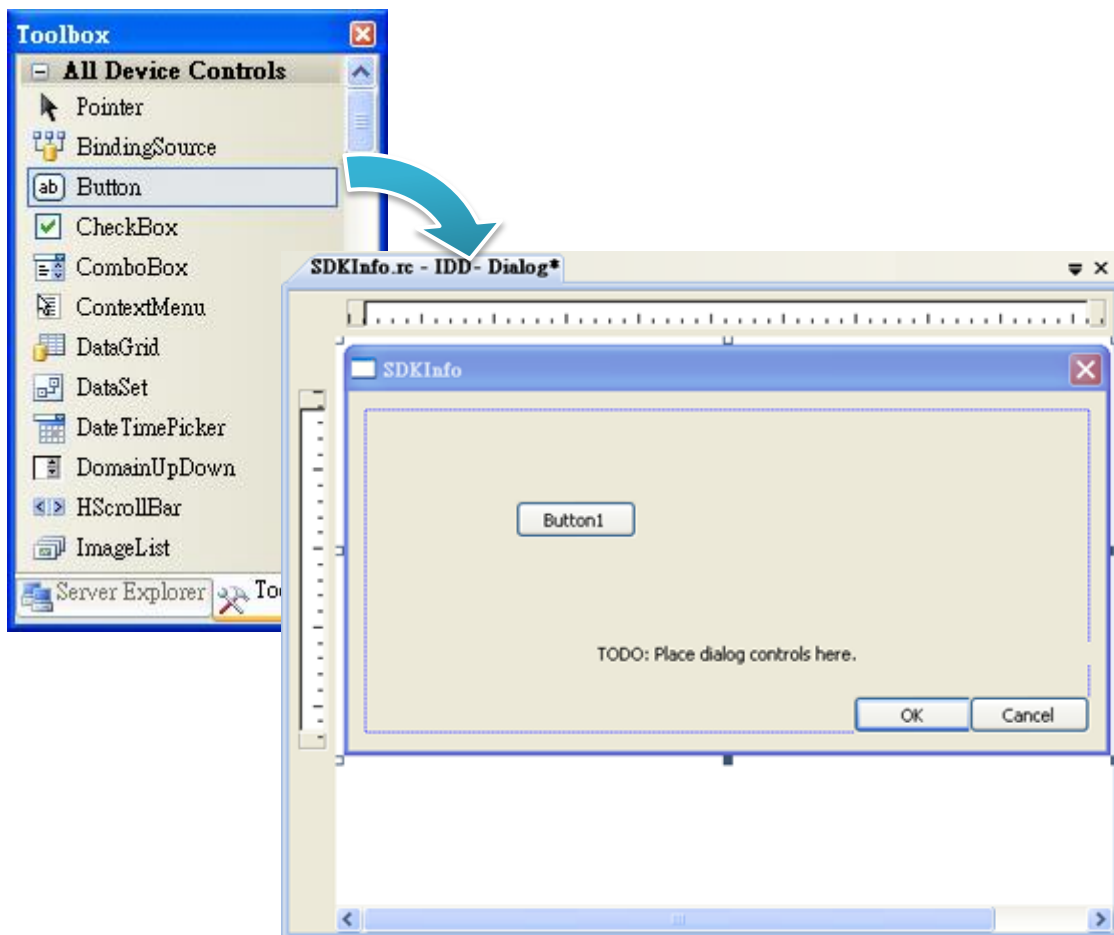

Step 2: On the Properties panel, type Check the SDK version in the Text field

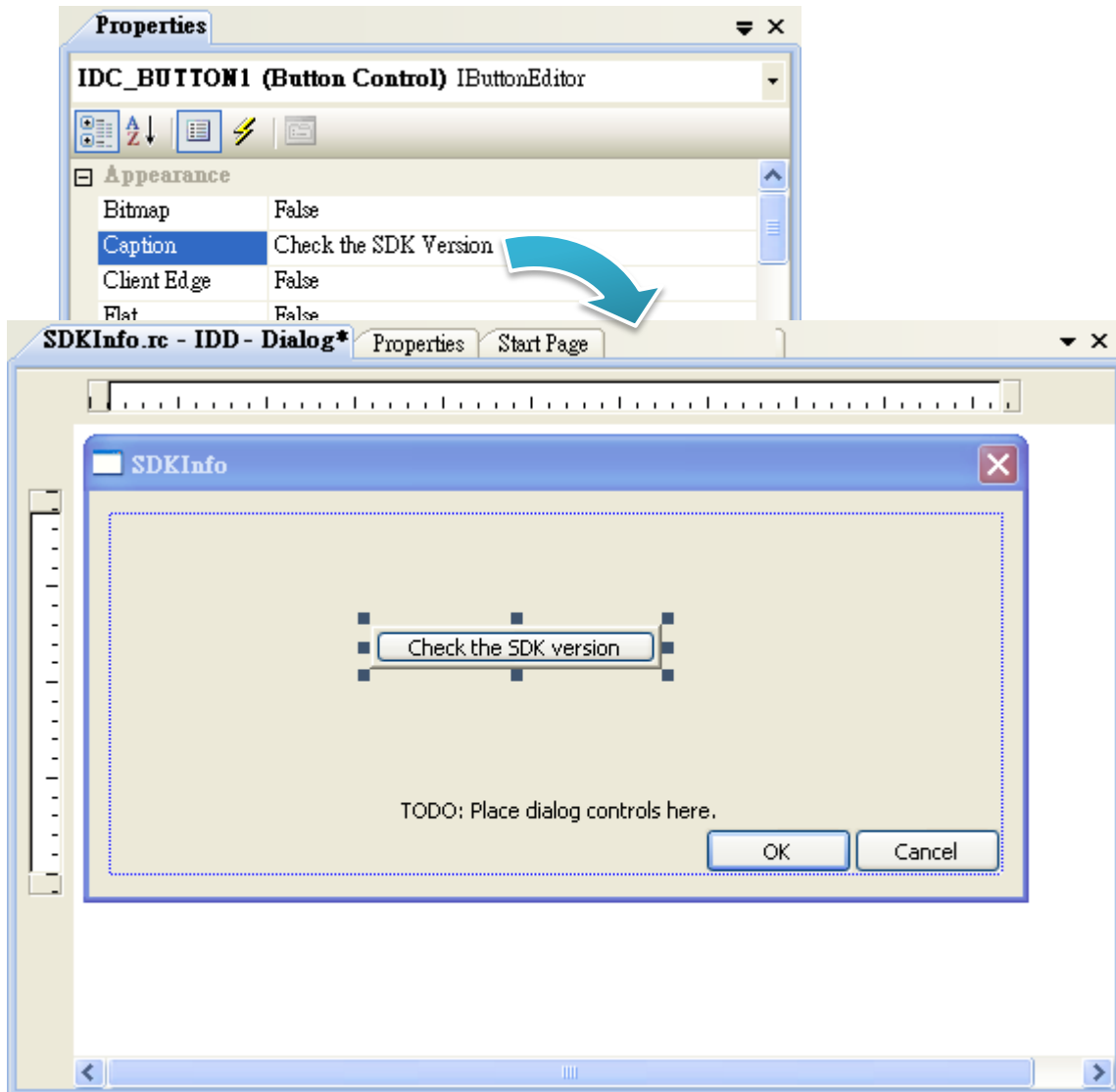

5.3.4. Add the event handling for the control

You have finished the design stage of your application and are at the point when you can start adding some code to provide the program's functionality.

Step 1: Double-click the button on the form

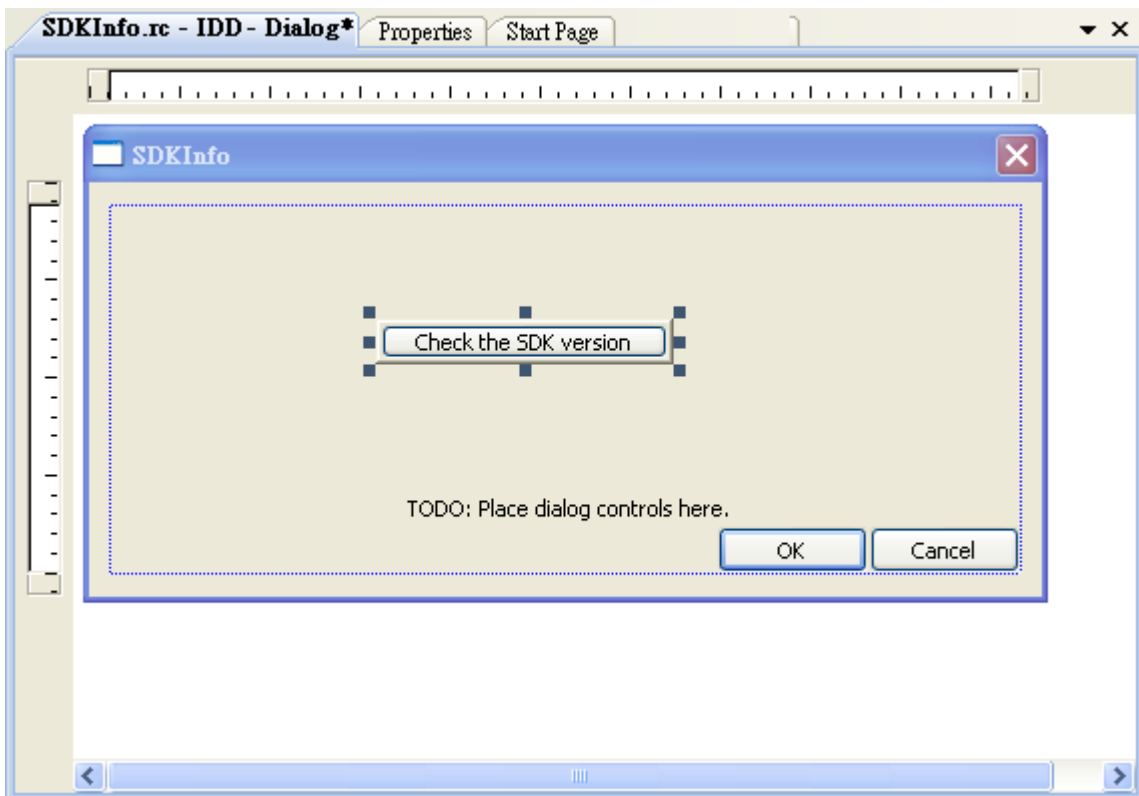

Step 2: Inserting the following code

```
char sdk_version[32];  
TCHAR buf[32];  
pac_GetSDKVersion(sdk_version);  
pac_AnsiToWideString(sdk_version, buf);  
MessageBox(buf,0,MB_OK);
```

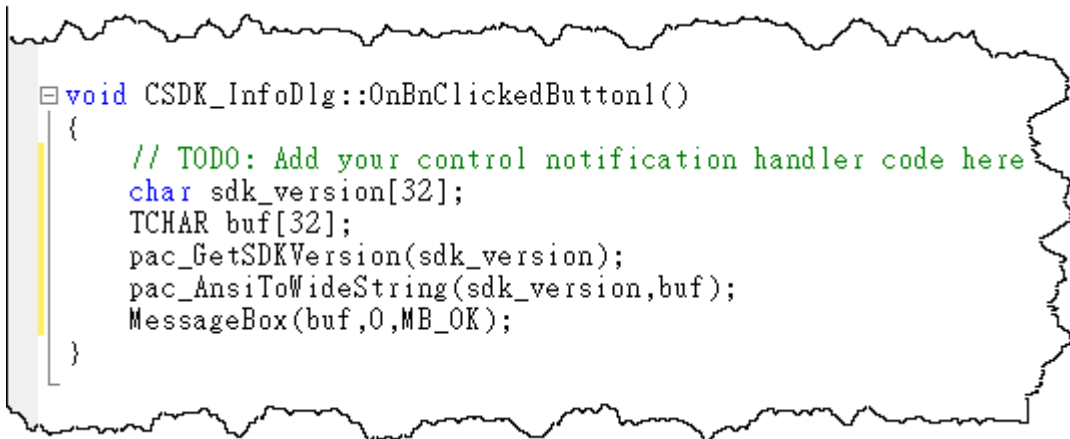

```
void CSDK_InfoDlg::OnBnClickedButton1()  
{  
    // TODO: Add your control notification handler code here  
    char sdk_version[32];  
    TCHAR buf[32];  
    pac_GetSDKVersion(sdk_version);  
    pac_AnsiToWideString(sdk_version, buf);  
    MessageBox(buf, 0, MB_OK);  
}
```

Step 2: Inserting the following code into the header area

```
#include "PACSDK.h"
```

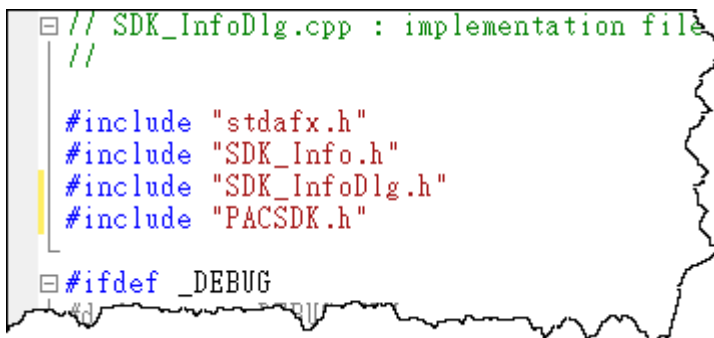

```
// SDK_InfoDlg.cpp : implementation file  
//  
#include "stdafx.h"  
#include "SDK_Info.h"  
#include "SDK_InfoDlg.h"  
#include "PACSDK.h"  
  
#ifdef _DEBUG
```

5.3.5. Upload the application to XP-8000

XP-8000 supports FTP server service. You can upload files to XP-8000 or download files from a public FTP server.

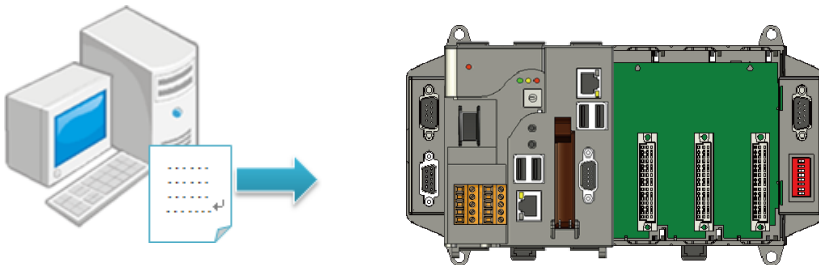

Step 1: On the **Build** menu, and then click **Build Solution**

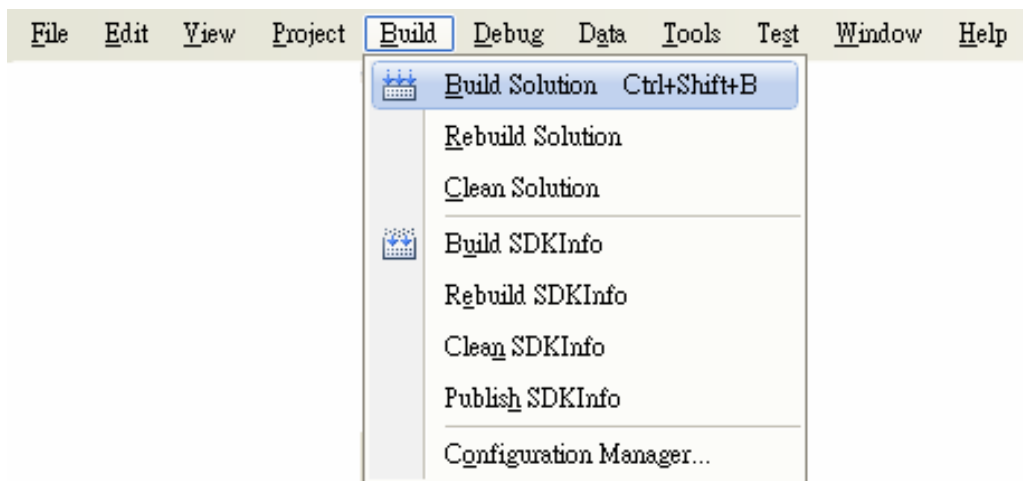

Step 2: Open the browser and type the IP address of XP-8000

Step 3: Upload the application to XP-8000



5.3.6. Execute the application on XP-8000

After uploading the application to XP-8000, you can just double-click it on XP-8000 to execute it.

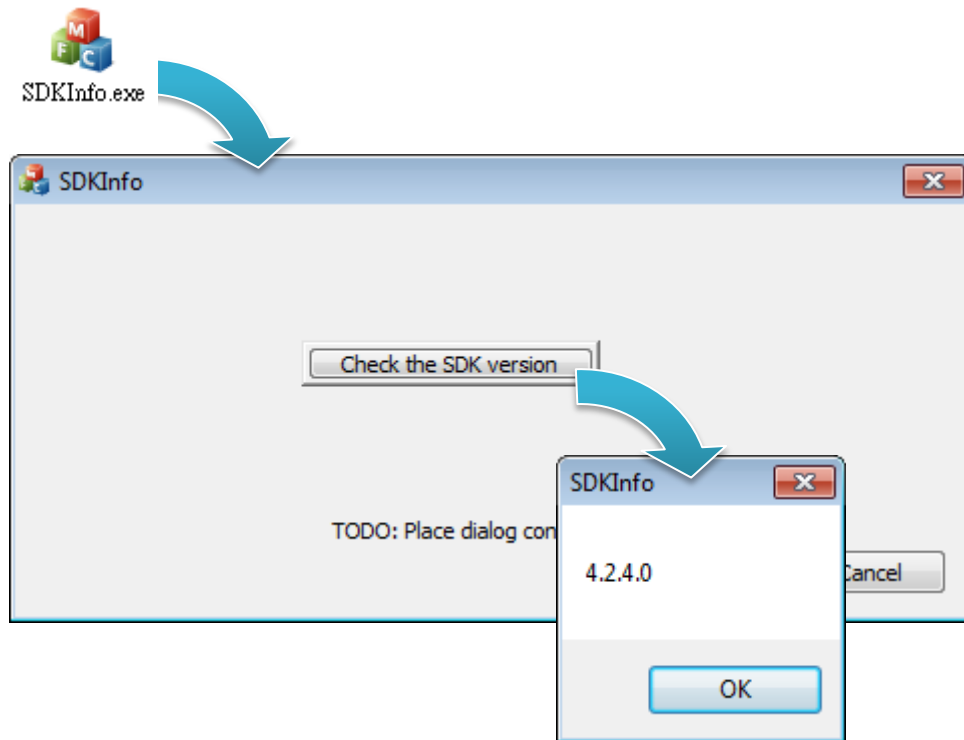

6. I/O Expansion Modules and SDKs Selection

This chapter describes how to select a suitable expansion I/O module and the corresponding SDK library to be used for developing programs on XP-8000.

XP-8000 provides the following I/O expansion buses:

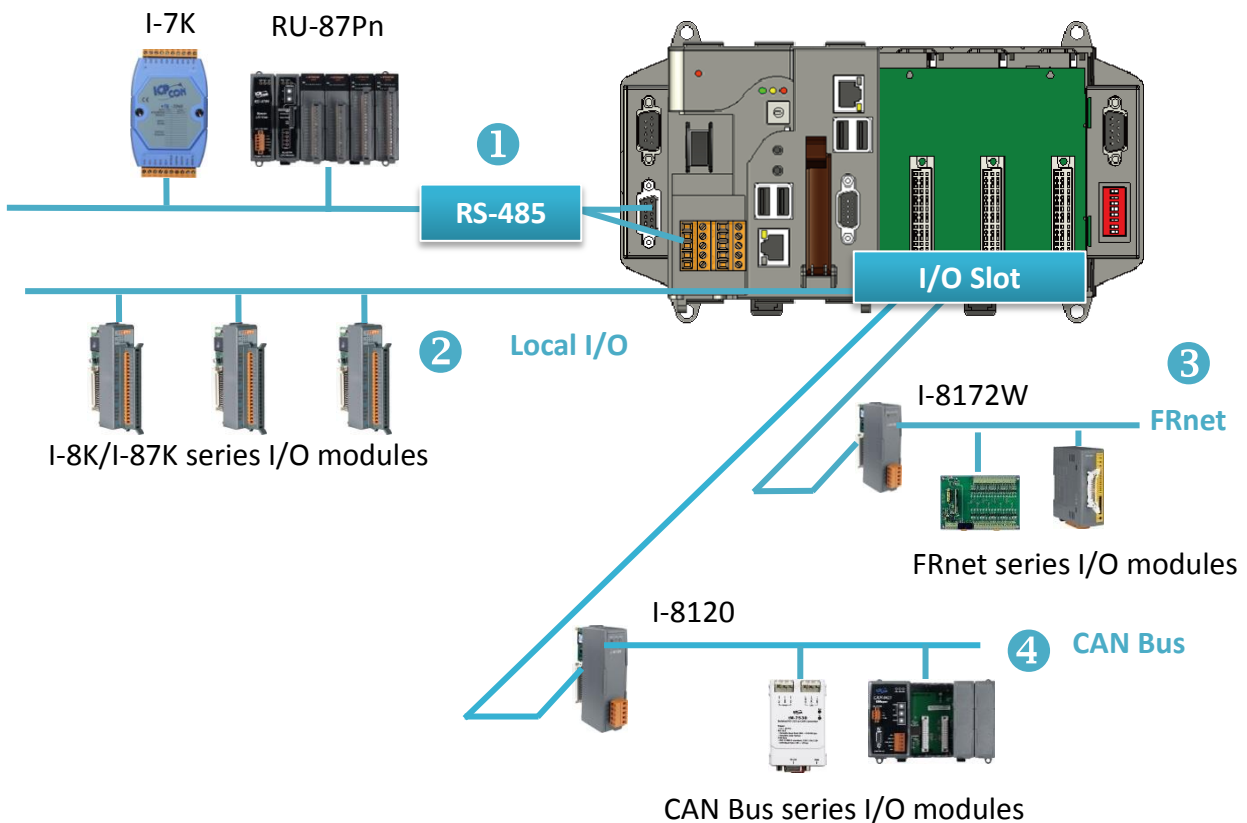

1. RS-485

I-7000, RU-87Pn and high profile I-87K series modules connect to XP-8000 via a twisted-pair, multi-drop, 2-wire RS-485 network.

➤ I-7000 series I/O module

Module	Native SDK	.NET CF SDK
I-7000 series	PACSDK.dll	PACNET.dll

For full details regarding I-7000 series I/O modules and its demos, please refer to:

- For XP-8x31-WES7:

<http://ftp.icpdas.com/pub/cd/ippc-wes7/demo/pacsdk/>

- For XP-8x41:

<http://ftp.icpdas.com/pub/cd/xp-8000/demo/pacsdk/>

- For XP-8x41-Atom:

<http://ftp.icpdas.com/pub/cd/xpac-atom/demo/pacsdk/>

➤ RU-87Pn + I-87K series I/O module

Module	Native SDK	.NET CF SDK
RU-87Pn+I-87K series	PACSDK.dll	PACNET.dll

➤ Other Specified I/O

Module	Native SDK	.NET CF SDK
Others	PACSDK.dll	PACNET.dll

2. Local I/O

XP-8000 has 0/1/3/7 expansion slot(s) that can be used to add expansion I/O modules. The expansion I/O modules can be divided into two categories: High Profile I-8K series I/O modules and High profile I-87K series I/O modules. The following indicates the appropriate SDK library to be used for I/O modules.

➤ General I-8K/I-87K series I/O module

Module	Native SDK	.NET CF SDK
I-8K series	PACSDK.dll	PACNET.dll
I-87K series	PACSDK.dll	PACNET.dll

For full details regarding I-8K and I-87K series I/O modules and its demos, please refer to:

▪ **For XP-8x31-WES7:**

<http://ftp.icpdas.com/pub/cd/ippc-wes7/demo/pacsdk/>

▪ **For XP-8x41:**

<http://ftp.icpdas.com/pub/cd/xp-8000/demo/pacsdk/>

▪ **For XP-8x41-Atom:**

<http://ftp.icpdas.com/pub/cd/xpac-atom/demo/pacsdk/>

➤ Other Specified I/O

Module	Native SDK	.NET CF SDK
I-8014W	pac_i8014W.dll	pac_i8014WNET.dll
I-8017HW	pac_i8017HW.dll	pac_i8017HWNET.dll
I-8024W	pac_i8024W.dll	pac_i8024WNET.dll
I-8026W	pac_i8026W.dll	pac_i8026WNET.dll
I-8048W	pac_i8048W.dll	pac_i8048WNET.dll
I-8050W	pac_i8050W.dll	pac_i8050WNET.dll
I-8084W	pac_i8084W.dll	pac_i8084WNET.dll
I-8088W	pac_i8088W.dll	pac_i8088WNET.dll
I-8093W	pac_i8093W.dll	pac_i8093WNET.dll
Others	PACSDK.dll	PACNET.dll

3. FRnet

FRnet is an innovative industrial field bus technology that uses twisted pair cable as the transmission medium. The status of all I/O devices is updated on a fixed cycle, no matter how many FRnet I/O modules are connected to the FRnet network.

Module	Native SDK	.NET CF SDK
I-8172W	pac_i8172W.lib	pac8172WNet.dll

4. CAN Bus

The Controller Area Network (CAN) is a serial communication way, which efficiently supports distributed real-time control with a very high level of security. It provides the error-processing mechanisms and concepts of message priority. These features can improve the network reliability and transmission efficiency.

Module	Native SDK	.NET CF SDK
I-8120W	i8120.lib	i8120net_pac.dll

7. APIs and Demo References

This chapter provides a brief overview of PAC standard APIs and demos that have been designed for XP-8000 from the PAC SDK package.

ICP DAS provides a set of demos in different programming languages. You can examine the demo codes, which includes numerous comments, to familiarize yourself with the PAC APIs. This will allow developing your own applications quickly by modifying these demo programs.

For full usage information regarding the description, prototype and the arguments of the functions, please refer to the “PAC Standard API Manual”

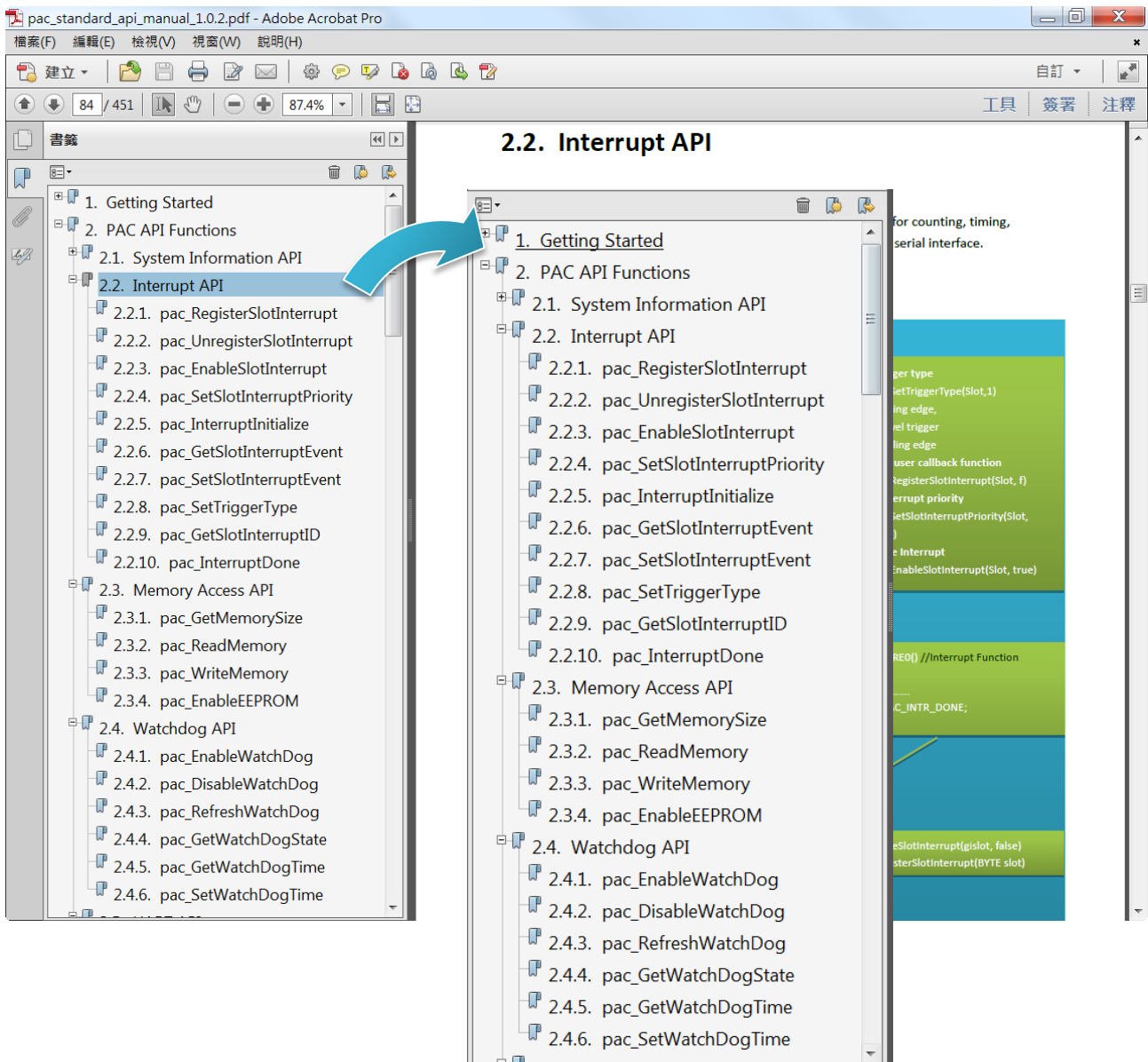

7.1. PAC Standard APIs for System Operation

The diagram below shows the set of each system operation API provided in the PACSDK.

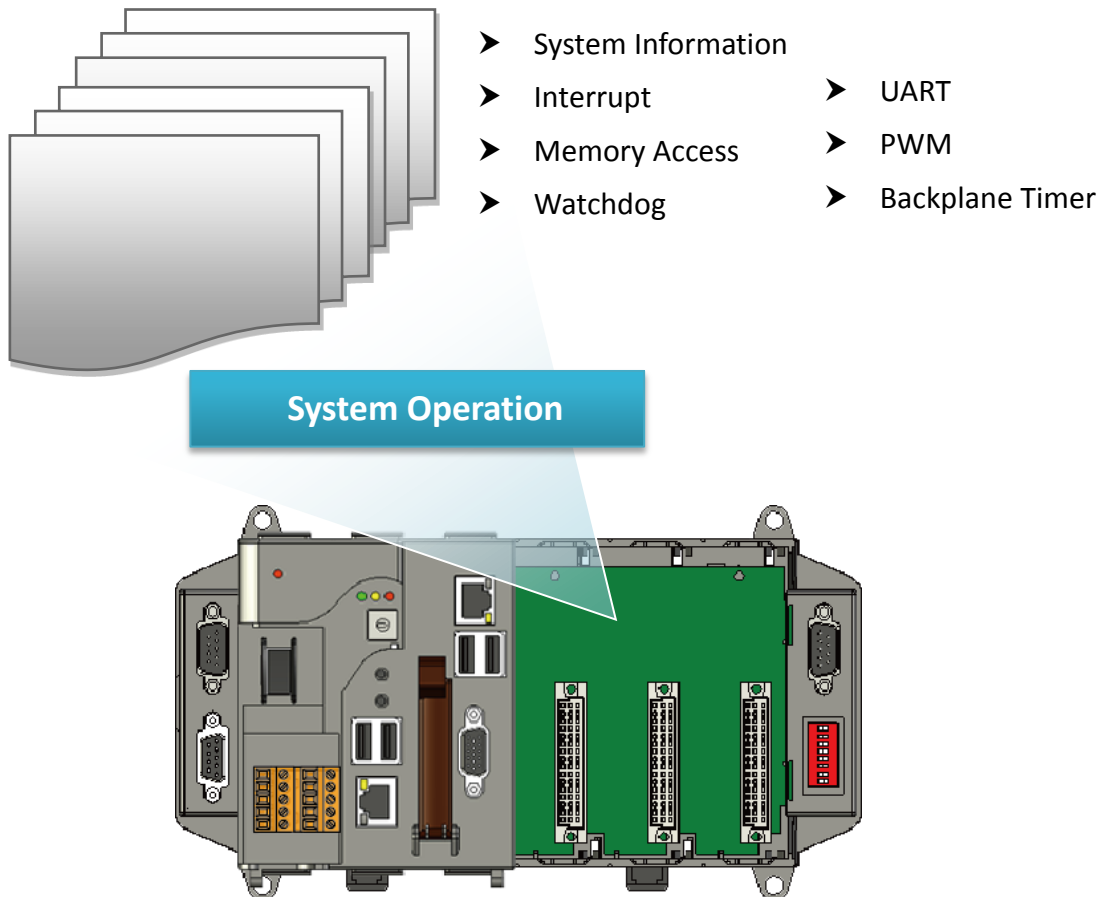

7.1.1. VB.NET Demos for PAC Standard APIs

The PAC SDK includes the following demos that demonstrate the use of the PAC Standard APIs in a VB.NET language environment.

The following demos can be found on the CD that was provided with the package or by downloading the latest version from ICP DAS web site.

▪ **For XP-8x31-WES7:**

CD:\ippc-wes7\demo\pacsdk\vb.net\standard\

<http://ftp.icpdas.com/pub/cd/ippc-wes7/demo/pacsdk/vb.net/standard/>

▪ **For XP-8x41:**

CD:\XP-8000\demo\pacsdk\vb.net\standard\

<http://ftp.icpdas.com/pub/cd/xp-8000/demo/pacsdk/vb.net/standard/>

▪ **For XP-8x41-Atom:**

CD:\XPAC-Atom\demo\pacsdk\vb.net\standard\

<http://ftp.icpdas.com/pub/cd/xpac-atom/demo/pacsdk/vb.net/standard/>

Folder	Demo	Explanation
deviceinformation	deviceinformation	Retrieves information about the OS version, the CPU version and the SDK version, etc.
diagnostic	diagnostic	Retrieves information about the slot count and the module inserted in the backplane.
dip	dip	Retrieves information about the status of the DIP switch.
getrotaryid	getrotaryid	Retrieves information about the status of the rotary switch.
memory	memory	Shows how to read/write date values from/to EEPROM.
uart	uart	Shows how to read the name of local I/O modules via UART
watchdog	watchdog	Displays information about how to operate the watchdog

7.1.2. C# Demos for PAC Standard APIs

The PAC SDK includes the following demos that demonstrate the use of the PAC Standard APIs in a C# language environment.

The following demos can be found on the CD that was provided with the package or by downloading the latest version from ICP DAS web site.

- **For XP-8x31-WES7:**

CD:\ippc-wes7\demo\pacsdk\csharp.net\standard\windows_forms\
http://ftp.icpdas.com/pub/cd/ippc-wes7/demo/pacsdk/csharp.net/standard/windows_forms/

- **For XP-8x41:**

CD:\XP-8000\demo\pacsdk\csharp.net\standard\windows_forms\
http://ftp.icpdas.com/pub/cd/xp-8000/demo/pacsdk/csharp.net/standard/windows_forms/

- **For XP-8x41-Atom:**

CD:\XPAC-Atom\demo\pacsdk\csharp.net\standard\windows_forms\
http://ftp.icpdas.com/pub/cd/xpac-atom/demo/pacsdk/csharp.net/standard/windows_forms/

Folder	Demo	Explanation
deviceinformation	deviceinformation	Retrieves information about the OS version, the CPU version and the SDK version, etc.
diagnostic	diagnostic	Retrieves information about the slot count and the module inserted in the backplane.
dip	dip	Retrieves information about the status of the DIP switch.
getrotaryid	getrotaryid	Retrieves information about the status of the rotary switch.
memory	memory	Shows how to read/write date values from/to EEPROM.
uart	uart	Shows how to read the name of local I/O modules via UART
watchdog	watchdog	Displays information about how to operate the watchdog

7.1.3. Visual C++ Demos for PAC Standard APIs

The PAC SDK includes the following demos that demonstrate the use of the PAC Standard APIs in a Visual C++ language environment.

The following demos can be found on the CD that was provided with the package or by downloading the latest version from ICP DAS web site.

▪ **For XP-8x31-WES7:**

CD:\ippc-wes7\demo\pacsdk\vc\standard\

<http://ftp.icpdas.com/pub/cd/ippc-wes7/demo/pacsdk/vc/standard/>

▪ **For XP-8x41:**

CD:\XP-8000\demo\pacsdk\vc\standard\

<http://ftp.icpdas.com/pub/cd/xp-8000/demo/pacsdk/vc/standard/>

▪ **For XP-8x41-Atom:**

CD:\XPAC-Atom\demo\pacsdk\vc\standard\

<http://ftp.icpdas.com/pub/cd/xpac-atom/demo/pacsdk/vc/standard/>

Folder	Demo	Explanation
deviceinformation	deviceinformation	Retrieves information about the OS version, the CPU version and the SDK version, etc.
diagnostic	diagnostic	Retrieves information about the slot count and the module inserted in the backplane.
dip	dip	Retrieves information about the status of the DIP switch.
getrotaryid	getrotaryid	Retrieves information about the status of the rotary switch.
memory	memory	Shows how to read/write date values from/to EEPROM.
uart	uart	Shows how to read the name of local I/O modules via UART
watchdog	watchdog	Displays information about how to operate the watchdog

7.2. PAC Standard APIs for PAC Expansion I/O

The diagram below shows the types of the PAC IO APIs provided in the PACSDK.

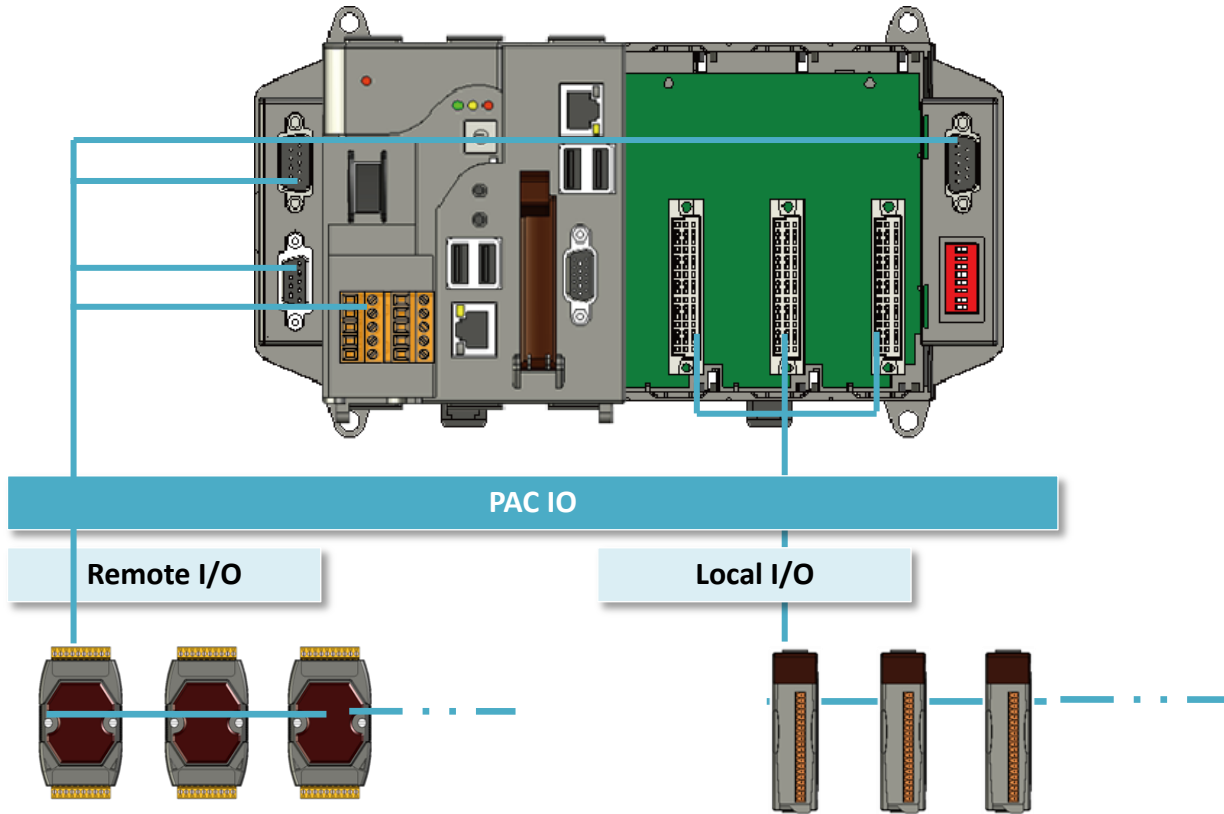

7.2.1. VB.NET Demos for PAC Expansion I/O

The PAC SDK includes the following demos that demonstrate the use of the PAC expansion I/O in a VB.NET language environment.

The following demos can be found on the CD that was provided with the package or by downloading the latest version from ICP DAS web site.

- **For XP-8x31-WES7:**

CD:\ippc-wes7\demo\pacsdk\vb.net\io\

<http://ftp.icpdas.com/pub/cd/ippc-wes7/demo/pacsdk/vb.net/io/>

- **For XP-8x41:**

CD:\XP-8000\demo\pacsdk\vb.net\standard\

<http://ftp.icpdas.com/pub/cd/xp-8000/demo/pacsdk/vb.net/io/>

- **For XP-8x41-Atom:**

CD:\XPAC-Atom\demo\pacsdk\vb.net\standard\

<http://ftp.icpdas.com/pub/cd/xpac-atom/demo/pacsdk/vb.net/io/>

Folder	Demo	Explanation
Local	find_io	Shows how to retrieve the module name and type which plugged in the XP-8000.
	8k_di	Shows how to read the DI values of DI module. This demo program is used by 8K series DI modules.
	8k_do	Shows how to write the DO values to DO module. This demo program is used by 8K series DO modules.
	8k_dio	Shows how to read the DI and the DO values of the DIO module. This demo program is used by 8K series DIO modules.
	87k_basic	Shows how to send/receive a command/response application. This demo program is used by 87K series modules.
	87K_demo	Shows how use uart API and the IO modules located as slots. This demo program is used by 87K series modules.
	87k_ai	Shows how to read the AI values of AI module. This demo program is used by 87K series AI modules.
	87k_ao	Shows how to write the AO values to AO module. This demo program is used by 87K series AO modules.
	87k_di	Shows how to read the DI values of DI module. This demo program is used by 87K series DI modules.

Folder	Demo	Explanation
Local	87k_do	Shows how to write the DO values to DO module. This demo program is used by 87K series DO modules.
	87k_dio	Shows how to read the DI and the DO values of the DIO module. This demo program is used by 87K series DIO modules.
Remote	7k87k_basic	Shows how to send/receive a command/response application. This demo program is used by 7K or 87K series AI modules which connected through a COM port.
	7k87k_ai	Shows how to read the AI values of AI module. This demo program is used by 7K or 87K series AI modules which connected through a COM port.
	7k87k_ao	Shows how to write the AO values to AO module. This demo program is used by 7K or 87K series AI modules which connected through a COM port.
	7k87k_di	Shows how to read the DI values of DI module. This demo program is used by 7K or 87K series AI modules which connected through a COM port.
	7k87k_do	Shows how to write the DO values to DO module. This demo program is used by 7K or 87K series AI modules which connected through a COM port.
	7k87k_dio	Shows how to read the DI and the DO values of the DIO module. This demo program is used by 7K or 87K series AI modules which connected through a COM port.

7.2.2. C# Demos for PAC Expansion I/O

The PAC SDK includes the following demos that demonstrate the use of the PAC expansion I/O in a C# language environment.

The following demos can be found on the CD that was provided with the package or by downloading the latest version from ICP DAS web site.

- **For XP-8x31-WES7:**

CD:\ippc-wes7\demo\pacsdk\csharp.net\io\

<http://ftp.icpdas.com/pub/cd/ippc-wes7/demo/pacsdk/csharp.net/io/>

- **For XP-8x41:**

CD:\XP-8000\demo\pacsdk\csharp.net\io\

<http://ftp.icpdas.com/pub/cd/xp-8000/demo/pacsdk/csharp.net/io/>

- **For XP-8x41-Atom:**

CD:\XPAC-Atom\demo\pacsdk\csharp.net\io\

<http://ftp.icpdas.com/pub/cd/xpac-atom/demo/pacsdk/csharp.net/io/>

Folder	Demo	Explanation
Local	find_io	Shows how to retrieve the module name and type which plugged in the XP-8000.
	8k_di	Shows how to read the DI values of DI module. This demo program is used by 8K series DI modules.
	8k_do	Shows how to write the DO values to DO module. This demo program is used by 8K series DO modules.
	8k_dio	Shows how to read the DI and the DO values of the DIO module. This demo program is used by 8K series DIO modules.
	87k_basic	Shows how to send/receive a command/response application. This demo program is used by 87K series modules.
	87K_demo	Shows how use uart API and the IO modules located as slots. This demo program is used by 87K series modules.
	87k_ai	Shows how to read the AI values of AI module. This demo program is used by 87K series AI modules.
	87k_ao	Shows how to write the AO values to AO module. This demo program is used by 87K series AO modules.
	87k_di	Shows how to read the DI values of DI module. This demo program is used by 87K series DI modules.

Folder	Demo	Explanation
Local	87k_do	Shows how to write the DO values to DO module. This demo program is used by 87K series DO modules.
	87k_dio	Shows how to read the DI and the DO values of the DIO module. This demo program is used by 87K series DIO modules.
Remote	7k87k_basic	Shows how to send/receive a command/response application. This demo program is used by 7K or 87K series AI modules which connected through a COM port.
	7k87k_ai	Shows how to read the AI values of AI module. This demo program is used by 7K or 87K series AI modules which connected through a COM port.
	7k87k_ao	Shows how to write the AO values to AO module. This demo program is used by 7K or 87K series AI modules which connected through a COM port.
	7k87k_di	Shows how to read the DI values of DI module. This demo program is used by 7K or 87K series AI modules which connected through a COM port.
	7k87k_do	Shows how to write the DO values to DO module. This demo program is used by 7K or 87K series AI modules which connected through a COM port.
	7k87k_dio	Shows how to read the DI and the DO values of the DIO module. This demo program is used by 7K or 87K series AI modules which connected through a COM port.

7.2.3. Visual C++ Demos for PAC Expansion I/O

The PAC SDK includes the following demos that demonstrate the use of the PAC expansion I/O in a C# language environment.

The following demos can be found on the CD that was provided with the package or by downloading the latest version from ICP DAS web site.

- **For XP-8x31-WES7:**

CD:\ippc-wes7\demo\pacsdk\vc\io\

<http://ftp.icpdas.com/pub/cd/ippc-wes7/demo/pacsdk/vc/io/>

- **For XP-8x41:**

CD:\XP-8000\demo\pacsdk\vc\io\

<http://ftp.icpdas.com/pub/cd/xp-8000/demo/pacsdk/vc/io/>

- **For XP-8x41-Atom:**

CD:\XPAC-Atom\demo\pacsdk\vc\io\

<http://ftp.icpdas.com/pub/cd/xpac-atom/demo/pacsdk/vc/io/>

Folder	Demo	Explanation
Local	find_io	Shows how to retrieve the module name and type which plugged in the XP-8000.
	8k_di	Shows how to read the DI values of DI module. This demo program is used by 8K series DI modules.
	8k_do	Shows how to write the DO values to DO module. This demo program is used by 8K series DO modules.
	8k_dio	Shows how to read the DI and the DO values of the DIO module. This demo program is used by 8K series DIO modules.
	87k_basic	Shows how to send/receive a command/response application. This demo program is used by 87K series modules.
	87K_demo	Shows how use uart API and the IO modules located as slots. This demo program is used by 87K series modules.
	87k_ai	Shows how to read the AI values of AI module. This demo program is used by 87K series AI modules.
	87k_ao	Shows how to write the AO values to AO module. This demo program is used by 87K series AO modules.
	87k_di	Shows how to read the DI values of DI module. This demo program is used by 87K series DI modules.

Folder	Demo	Explanation
Local	87k_do	Shows how to write the DO values to DO module. This demo program is used by 87K series DO modules.
	87k_dio	Shows how to read the DI and the DO values of the DIO module. This demo program is used by 87K series DIO modules.
Remote	7k87k_basic	Shows how to send/receive a command/response application. This demo program is used by 7K or 87K series AI modules which connected through a COM port.
	7k87k_ai	Shows how to read the AI values of AI module. This demo program is used by 7K or 87K series AI modules which connected through a COM port.
	7k87k_ao	Shows how to write the AO values to AO module. This demo program is used by 7K or 87K series AI modules which connected through a COM port.
	7k87k_di	Shows how to read the DI values of DI module. This demo program is used by 7K or 87K series AI modules which connected through a COM port.
	7k87k_do	Shows how to write the DO values to DO module. This demo program is used by 7K or 87K series AI modules which connected through a COM port.
	7k87k_dio	Shows how to read the DI and the DO values of the DIO module. This demo program is used by 7K or 87K series AI modules which connected through a COM port.

8. Recovery and Restore

This chapter provides information of the XP-8000 restore and recovery, and a guided tour that describes the steps needed to restore and recovery the XP-8000.

The XP-8000 comes with a rescue CF card that can be used to not only boot the XP-8000 when the OS fails to load, but also recover files.

The recovery file of the rescue CF card can be found separately on the CD that was provided with the package or by downloading the latest version from ICP DAS web site.

- **For XP-8x31-WES7:**

CD:\ippc-wes7\Rescue_Disk\

http://ftp.icpdas.com/pub/cd/ippc-wes7/rescue_disk/

- **For XP-8x41:**

CD:\XP-8000\Rescue_Disk\

http://ftp.icpdas.com/pub/cd/xp-8000/rescue_disk/

- **For XP-8x41-Atom:**

CD:\XPAC-ATOM\Rescue_Disk\

http://ftp.icpdas.com/pub/cd/xpac-atom/rescue_disk/

8.1. XP-8000 Recovery

If the XP-8000 crashes and won't start up, you can use the rescue CF card to start up the XP-8000 and then fix the problem that caused the crash.

8.1.1. Recovering the XP-8x31-WES7

Here are step by step instructions on how to recovering the XP-8x31-WES7.

Step 1: Plug the CF card in CF slot and turn the rotary switch in position 0

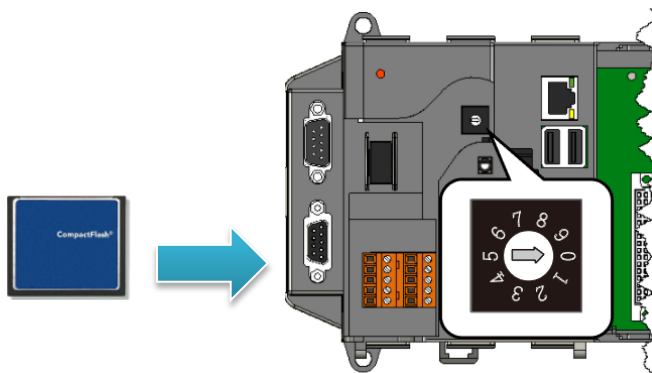

Step 2: Reboot the XP-8000, press Delete key to enter the BIOS setup utility

Step 3: On the Boot menu, select Hard Disk Drives and then press Enter key

BIOS SETUP UTILITY						
Main	Advanced	PCIPnP	Boot	Security	Chipset	Exit
Boot Settings					Specifies the Boot Device Priority sequence from available Hard drives	
Boot Settings Configuration						
Hard Disk Drives						

Step 4: Select 1st Drive and then press Enter key

Step 5: Set 1st Drive as PM-CF Card, it means the XP-8000 booting from the CF card

BIOS SETUP UTILITY						
Main	Advanced	PCIPnP	Boot	Security	Chipset	Exit
Hard Disk Drivers					Specifies the Boot sequence from available drives	
1st Drive			[SATA: PM-CF Card]			
2nd Drive			[SATA: SM-InnoDisk C]			

Step 6: Press F10 key and select OK to exit the setup utility and reboot the XP-8000

After rebooting the XP-8000, the system will enter the XP-8000 Rescue Utility.

Step 7: Select the Yes, I accept the EULA option, and then click the Start WES Recovery button for starting the recovery process



Step 8: Click OK button to reboot the XP-8000

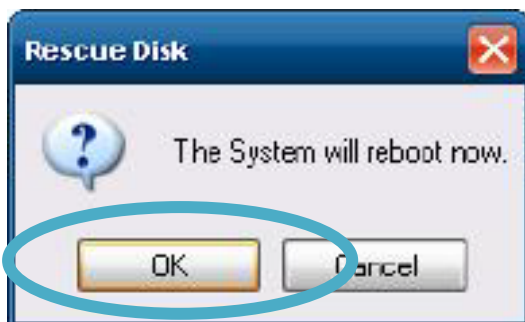

Step 9: Repeat step 2 to step 6 to set 1st Drive as SM-InnoDisk C

SM-InnoDisk C means Built-in flash.

BIOS SETUP UTILITY						
Main	Advanced	PCIPnP	Boot	Security	Chipset	Exit
Hard Disk Drivers					Specifies the Boot sequence from available drives	
1st Drive			[SATA: SM-InnoDisk C]			
2nd Drive			[SATA: PM-CF Card]			

Step 10: The XP-8000 has been recovered

Tips & Warnings



After recovery, please do not unplug the CF card from the XP-8000 until the initial settings of OS is complete.

8.1.2. Recovering the XP-8x41-Atom

Here are step by step instructions on how to recovering the XP-8x41-Atom.

Step 1: Plug the CF card in CF slot and turn the rotary switch in position 0

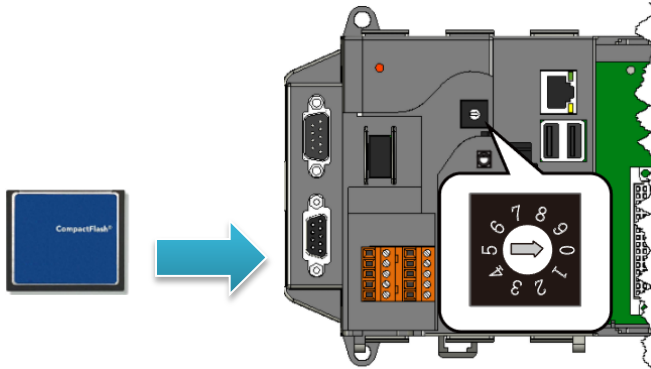

Step 2: Reboot the XP-8000-Atom, press Delete key to enter the BIOS setup utility

Step 3: On the Boot menu, select Hard Disk Drives and then press Enter key

BIOS SETUP UTILITY						
Main	Advanced	PCIPnP	Boot	Security	Chipset	Exit
Boot Settings					Specifies the Boot Device Priority	
Boot Settings Configuration					sequence from available Hard drives	
Hard Disk Drives						

Step 4: Select 1st Drive and then press Enter key

Step 5: Set 1st Drive as PS-xxx, it means the XP-8000-Atom booting from the CF card

BIOS SETUP UTILITY						
Main	Advanced	PCIPnP	Boot	Security	Chipset	Exit
Hard Disk Drivers				Specifies the Boot sequence from available drives		
1st Drive			[SATA: PS-xxx]			
2nd Drive			[SATA: PM-xxx]			

Step 6: Press F10 key and select OK to exit the setup utility and reboot the XP-8000-Atom

After rebooting the XP-8000-Atom, the system will enter the XP-8000-Atom Rescue Utility.

```
*****
*          XP-8000-Atom Rescue Disk -- Main Menu          *
*****

Choose one of the followings:

(1) Recover XP-8000-Atom to factory default
(2) Upgrade XP-8000-Atom manually
(3) Display Drive [C]
(4) Quit rescue disk and reboot
(5) Command Shell

Enter Choice:
```

Step 7: Enter 1, (1) Recover XP-8000-Atom to factory default

The system will recovery to the factory default settings, and wait a while until the system enter the XP-8000-Atom Rescue Utility again.

```
*****
*      XP-8000-Atom Rescue Disk -- Main Menu      *
*****

Choose one of the followings:

(1) Recover XP-8000-Atom to factory default
(2) Upgrade XP-8000-Atom manually
(3) Display Drive [C]
(4) Quit rescue disk and reboot
(5) Command Shell

Enter Choice: 1
```

Step 8: Enter 4, (4) Quit rescue disk and reboot

```
*****
*      XP-8000-Atom Rescue Disk -- Main Menu      *
*****

Choose one of the followings:

(1) Recover XP-8000-Atom to factory default
(2) Upgrade XP-8000-Atom manually
(3) Display Drive [C]
(4) Quit rescue disk and reboot
(5) Command Shell

Enter Choice: 4
```

Step 9: Repeat step 2 to step 6 to set 1st Drive as PM-xxx

PM-xxx means Built-in flash.

BIOS SETUP UTILITY						
Main	Advanced	PCIPnP	Boot	Security	Chipset	Exit
Hard Disk Drivers					Specifies the Boot sequence from available drives	
1st Drive			[SATA: PM-xxx]			
2nd Drive			[SATA: PS-xxx]			

Step 10: The XP-8000-Atom has been recovered

8.1.3. Recovering the XP-8x41

Here are step by step instructions on how to recovering the XP-8x41.

Step 1: Plug the CF card in CF slot and turn the rotary switch in position 0

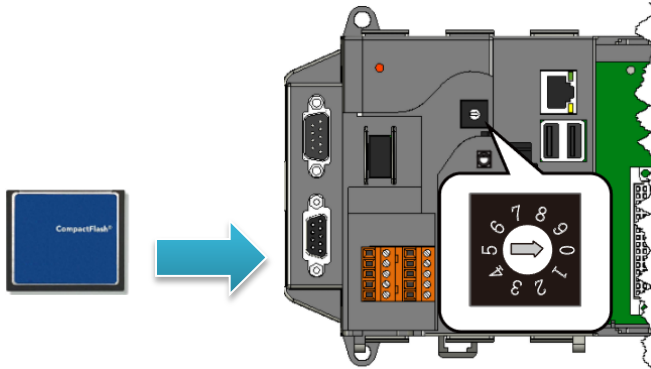

Step 2: Reboot the XP-8000, press Delete key to enter the BIOS setup utility

Step 3: Select Advanced BIOS Features and then press Enter key

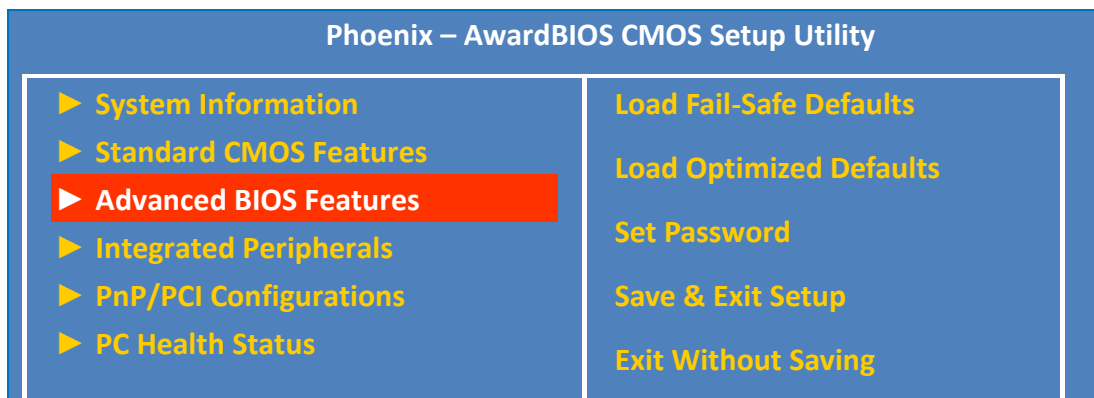

Step 4: Select First Boot Device and then press Enter key

Step 5: Set First Boot Device as HDD-1, it means the XP-8000 booting from the CF card

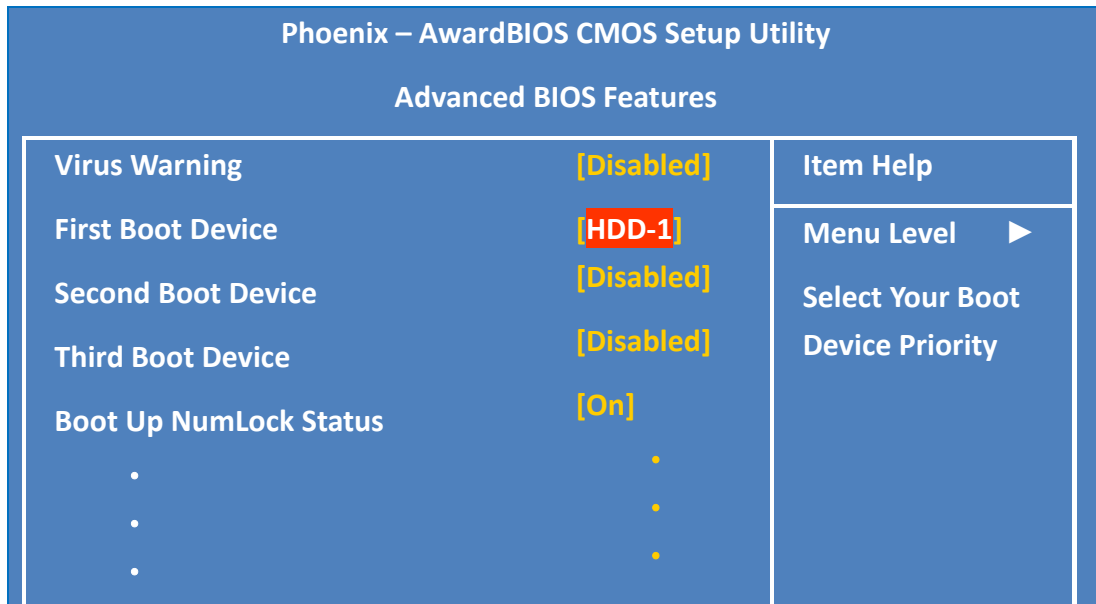

Step 6: Press F10 key and select OK to exit the setup utility and reboot the XP-8000

After rebooting the XP-8000, the system will enter the XP-8000 Rescue Utility.

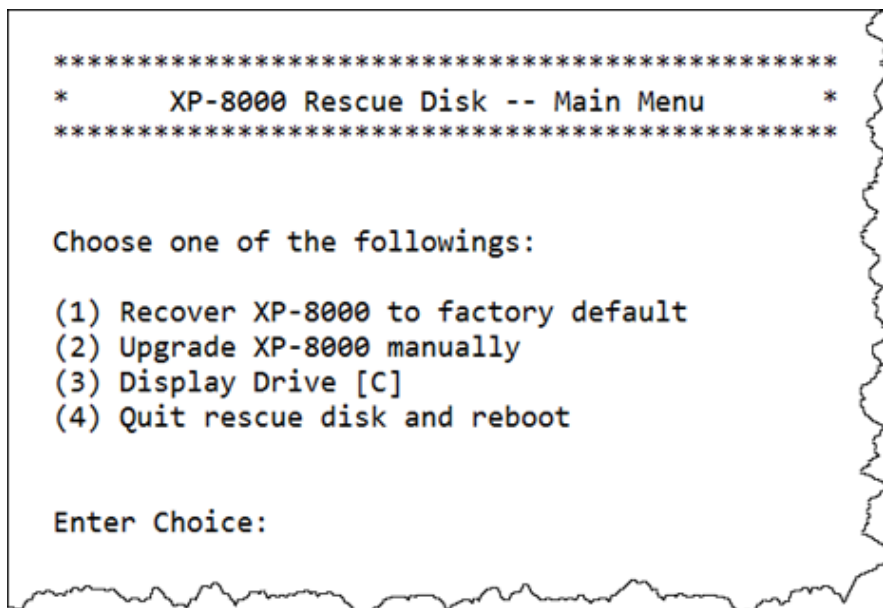

Step 7: Enter 1, (1) Recover XP-8000 to factory default

The system will recovery to the factory default settings, and wait a while until the system enter the XP-8000 Rescue Utility again.

```
*****
*      XP-8000 Rescue Disk -- Main Menu      *
*****

Choose one of the followings:

(1) Recover XP-8000 to factory default
(2) Upgrade XP-8000 manually
(3) Display Drive [C]
(4) Quit rescue disk and reboot

Enter Choice: 1
```

Step 8: Enter 4, (4) Quit rescue disk and reboot

```
*****
*      XP-8000 Rescue Disk -- Main Menu      *
*****

Choose one of the followings:

(1) Recover XP-8000 to factory default
(2) Upgrade XP-8000 manually
(3) Display Drive [C]
(4) Quit rescue disk and reboot

Enter Choice: 4
```

Step 9: Repeat step 2 to step 6 to set First Boot Device as HDD-0

HDD-0 means Built-in flash.

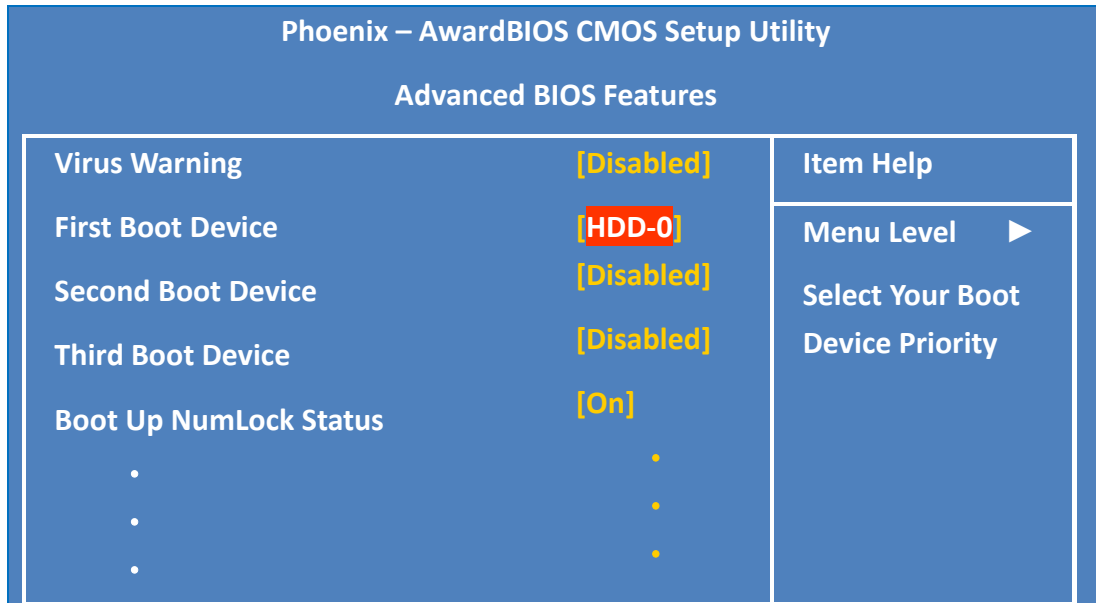

Step 10: The XP-8000 has been recovered

8.2. Restoring the Rescue CF Card

The rescue CF card is rescue equipment that allows you to perform some maintenance tasks on your system in case of failure.

Once the rescue CF card are partitioned or formatted, you must restore the rescue CF card.

Requirements

For restoring the Rescue CF card, you should prepare Ghost 11 or later, which you could obtain by contacting Symantec (<http://www.symantec.com>)

Here are step by step instructions on how to restore the rescue CF card. In this demonstration, we will use Symantec Norton Ghost32 V.11.0 (The Symantec Norton Ghost V.11 or above version are recommend).

Step 1: Get the latest version of rescue ghost file, rescue.gho

The latest version of rescue.gho file can be found by downloading the latest version from ICP DAS web site.

- **For XP-8x31-WES7:**

http://ftp.icpdas.com/pub/cd/ippc-wes7/rescue_disk/

- **For XP-8x41:**

http://ftp.icpdas.com/pub/cd/xp-8000/rescue_disk/

- **For XP-8x41-Atom:**

http://ftp.icpdas.com/pub/cd/xpac-atom/rescue_disk/

Step 2: Start the Symantec Norton Ghost32 V.11, and then click OK

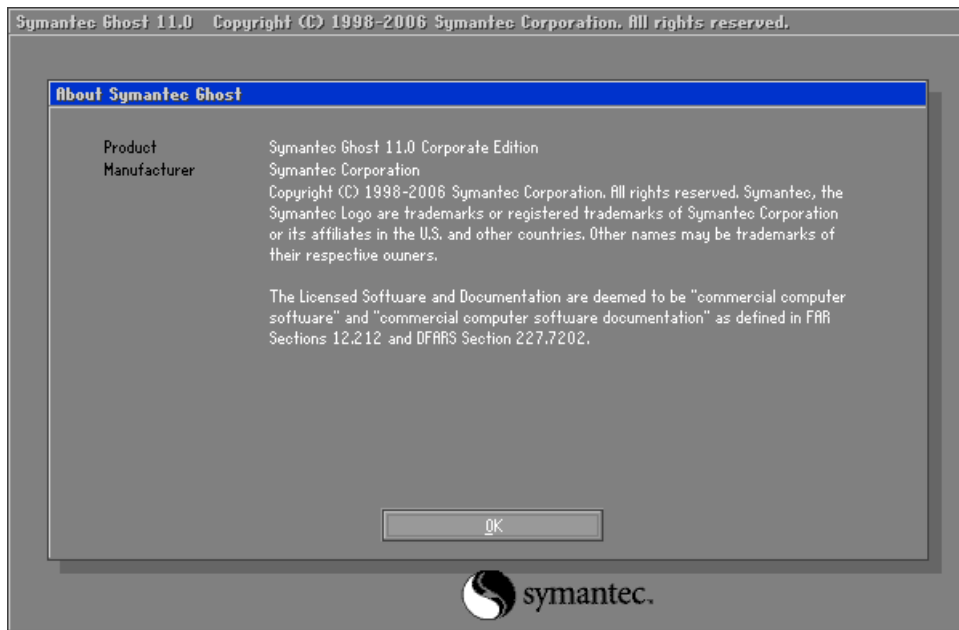

Step 3: Click Function Menu, point to Local, point to Disk, and then click From Image

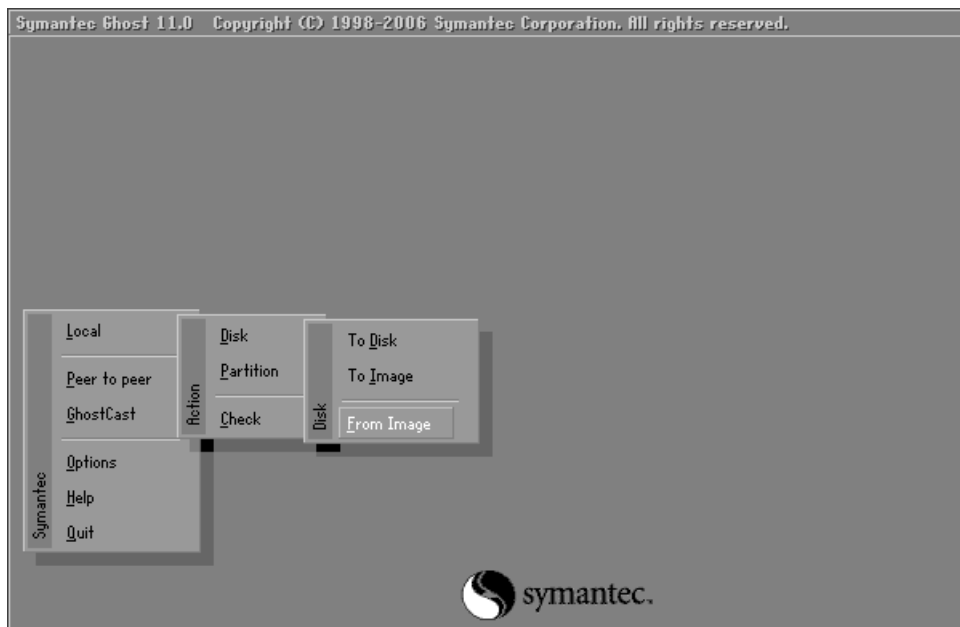

Step 4: Select the rescue ghost file that you saved, and then click Open

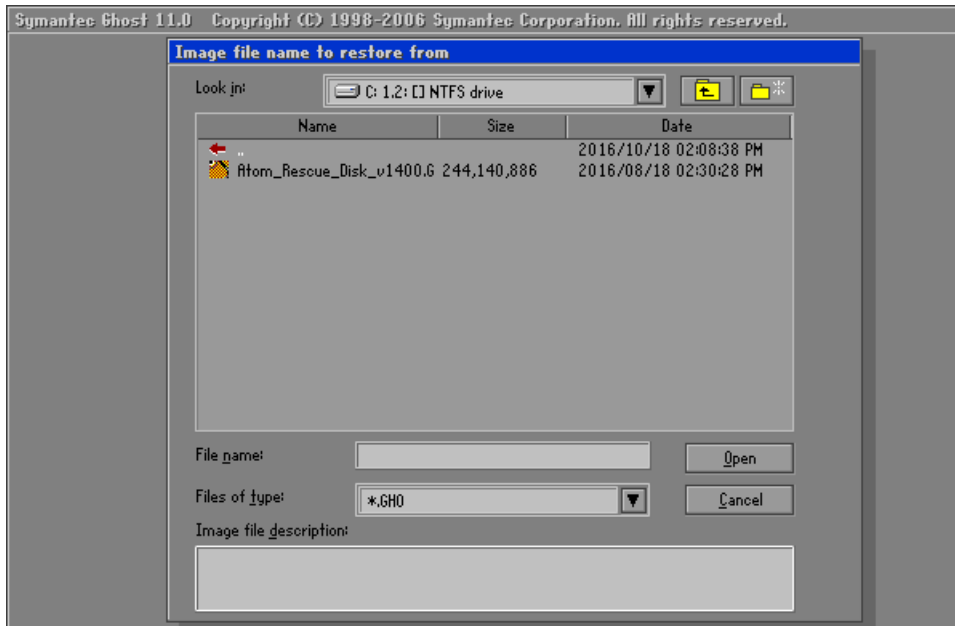

Step 5: Select the destination to CF card and click then OK

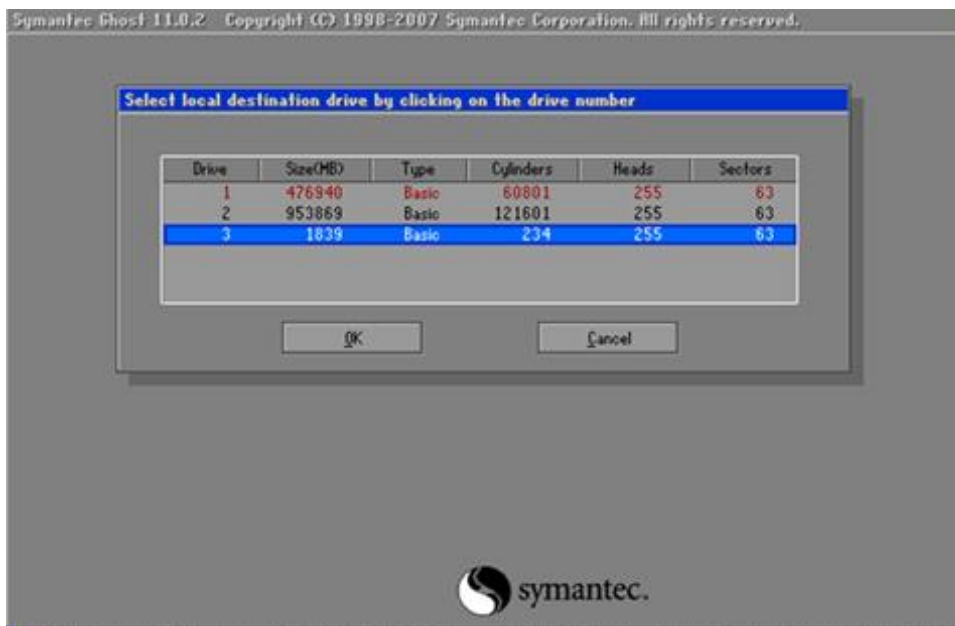

Step 6: Recover the rescue ghost file into CF card and then click OK

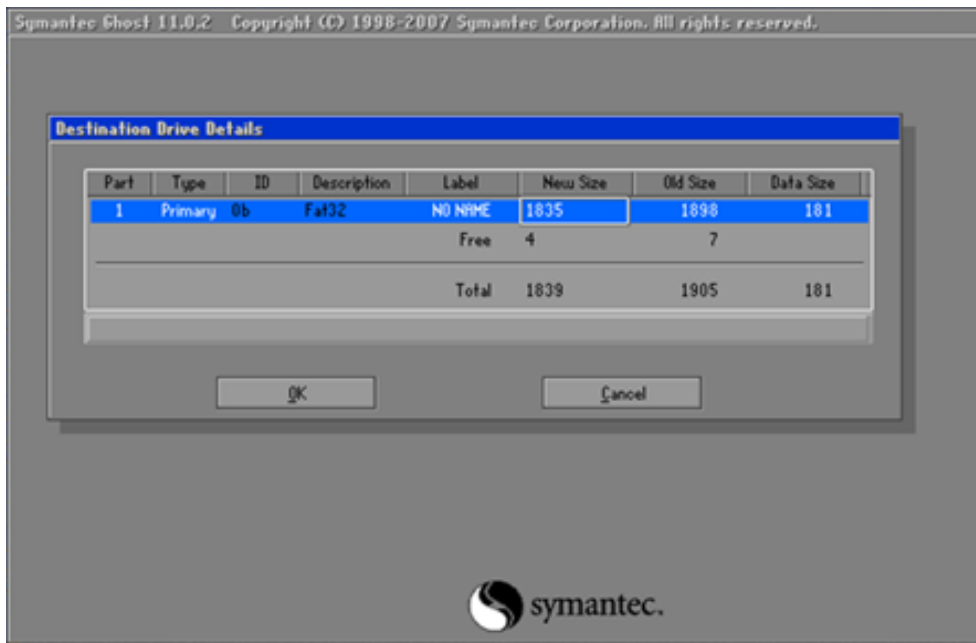

Step 7: The rescue CF card has been done

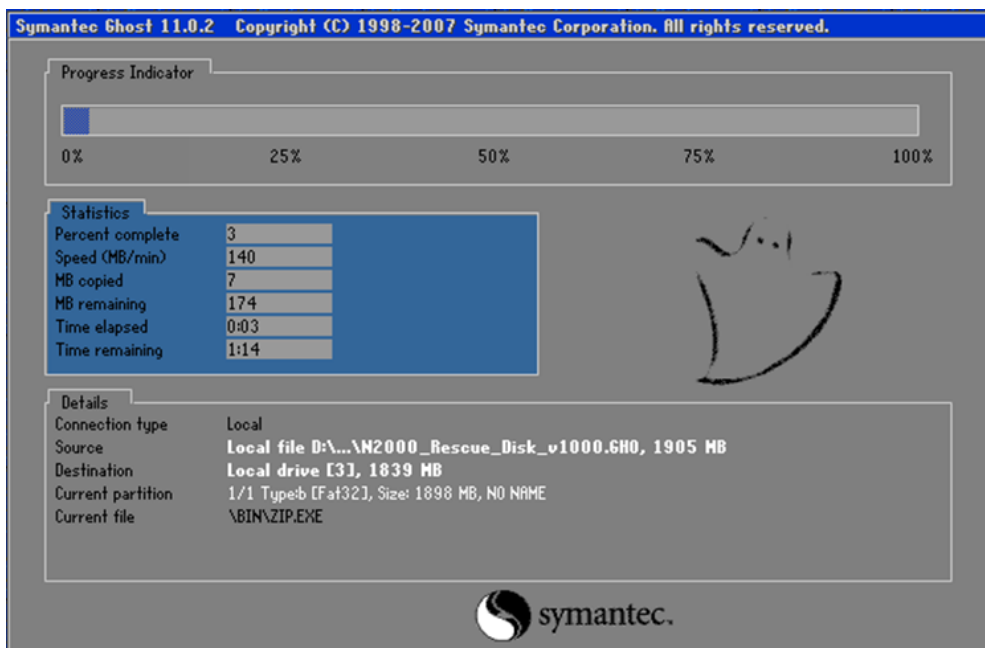

9. XP-8000 Updates

This chapter provides information of the XP-8000 OS and SDKs, and a guided tour that demonstrates the steps needed to update the XP-8000 OS and SDKs.

ICP DAS will continue to add additional features to XP-8000 OS and SDKs in the future, so we advise you to periodically check the ICP DAS web site for the latest updates.

Both the files of OS updates and SDK updates can be found on the CD that was provided with the package or by downloading the latest version from ICP DAS web site.

- For XP-8x31-WES7:
CD:\ippc-wes7\
<ftp://ftp.icpdas.com/pub/cd/ippc-wes7/>
- For XP-8x41:
CD:\XP-8000\
<http://ftp.icpdas.com/pub/cd/xp-8000/>
- For XP-8x41-Atom:
CD:\XPAC-Atom\
<http://ftp.icpdas.com/pub/cd/xpac-atom/>

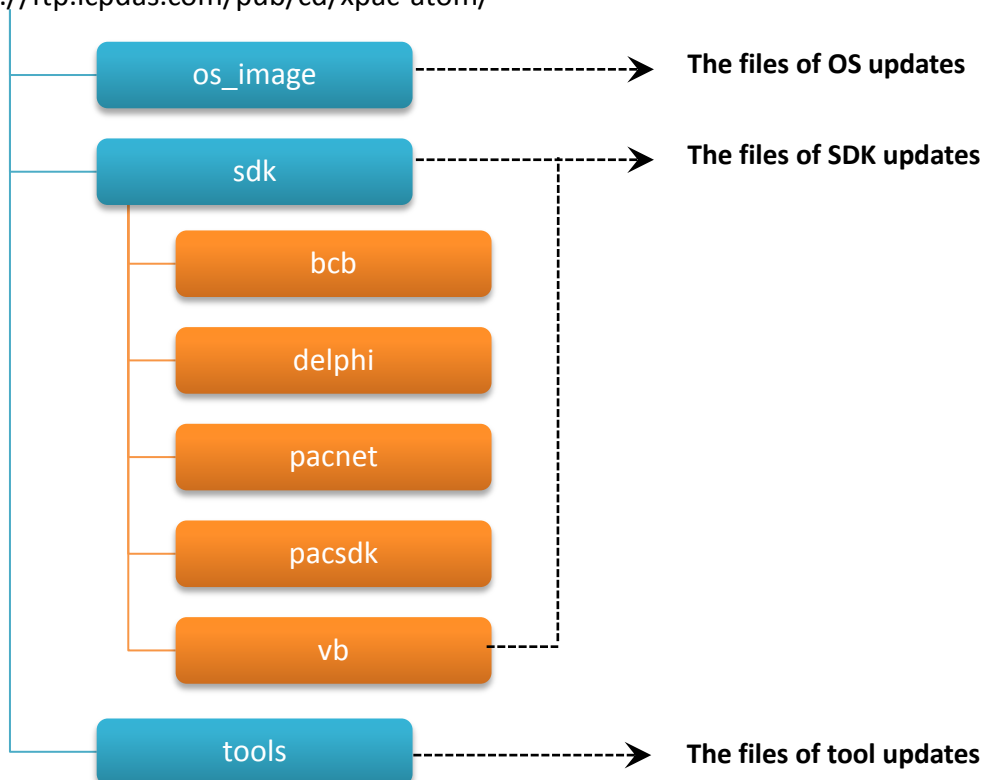

9.1. Updating the XP-8000 OS

ICP DAS will continue to add additional features and improve performances to XP-8000 OS in the future, so we advise you to periodically check the ICP DAS web site for the latest updates.

The information can be obtained from:

- **For XP-8x31-WES7:**

http://ftp.icpdas.com/pub/cd/ippc-wes7/os_image/

- **For XP-8x41:**

http://ftp.icpdas.com/pub/cd/xp-8000/os_image/

- **For XP-8x41-Atom:**

http://ftp.icpdas.com/pub/cd/xpac-atom/os_image/

Free feel to contact us to get the latest version of OS image.

E-mail: service@icpdas.com

9.2. Updating the XP-8000 SDK

ICP DAS will continue to include more functionality and API calls to XP-8000 SDK in the future, so we advise you to periodically check the ICP DAS web site for the latest updates.

Step 1: Download the latest version of the pacsdk.dll

The latest version of the pacsdk.dll file can be obtained from ICP DAS web site.

- For XP-8x31-WES7:

<http://ftp.icpdas.com/pub/cd/ippc-wes7/sdk/pacsdk/>

- For XP-8x41:

<http://ftp.icpdas.com/pub/cd/xp-8000/sdk/pacsdk/>

- For XP-8x41-Atom:

<http://ftp.icpdas.com/pub/cd/xpac-atom/sdk/pacsdk/>

Step 2: Copy the downloaded file, pacsdk.dll, into the C:\Windows\System32\ folder

This will overwrite the existing pacsdk.dll file.

Step 3: Run the PAC Utility, and then commit the EWF overlay

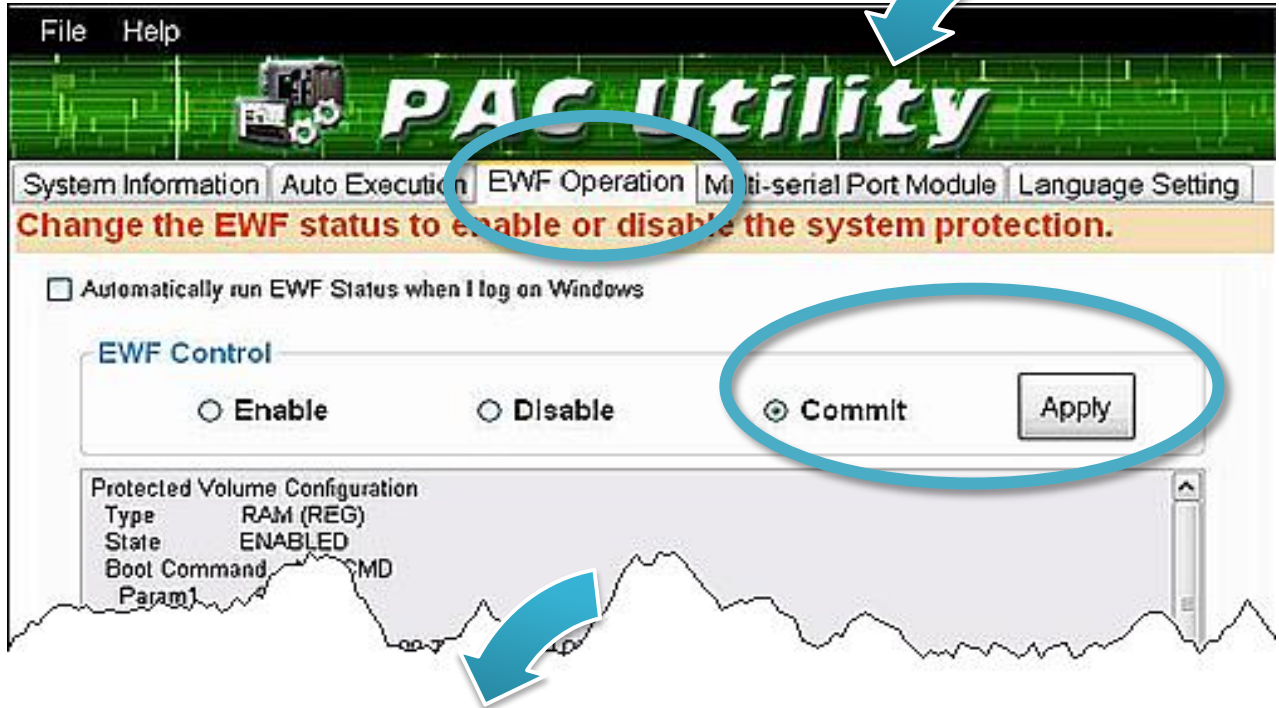

For XP-8x41 and
XP-8x41-Atom:

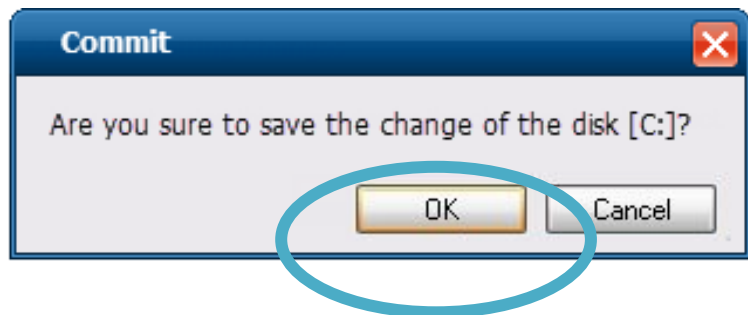

For XP-8x31-WES7:

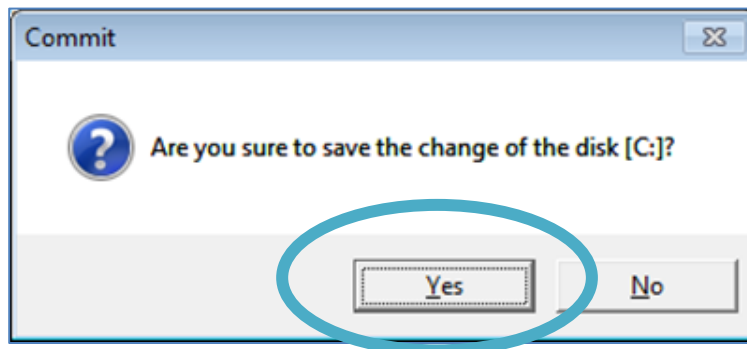

Step 4: Log off the XP-8000, and then login again for changes to take effect.

For XP-8x41 and XP-8x41-Atom:

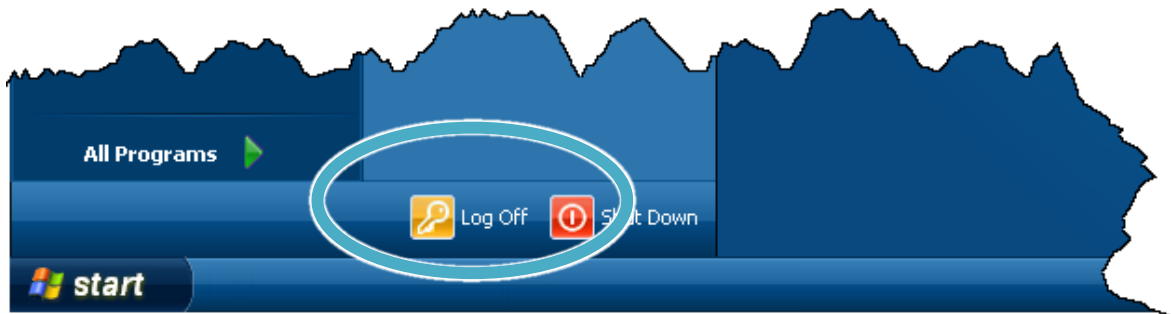

For XP-8x31-WES7:

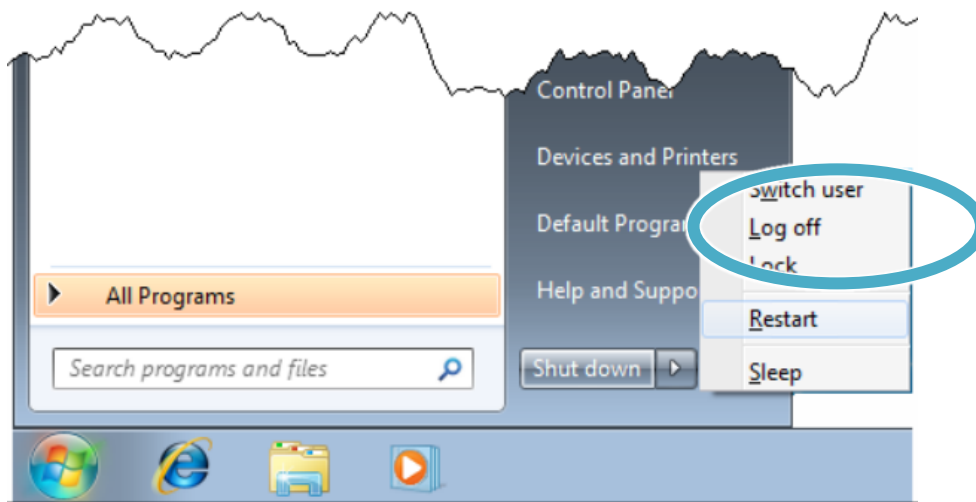

9.3. Updating the PAC Utility

ICP DAS will continue to add more functionality and support to the PAC utility in the future, so we advise you to periodically check the ICP DAS web site for the latest updates.

Step 1: Get the latest version of PAC Utility in PC or a laptop

The latest version of rescue.gho file can be found by downloading the latest version from ICP DAS web site.

- For XP-8x31-WES7:
http://ftp.icpdas.com/pub/cd/ippc-wes7/tools/pac_utility/
- For XP-8x41:
http://ftp.icpdas.com/pub/cd/xp-8000/tools/pac_utility/
- For XP-8x41-Atom:
http://ftp.icpdas.com/pub/cd/xpac-atom/tools/pac_utility/

Step 2: Extract the downloaded file, and then copy the file folder to the CF card

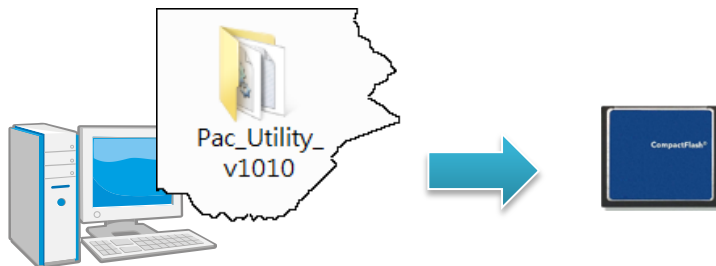

Step 3: Plug the Rescue CF card into CF slot in XP-8000

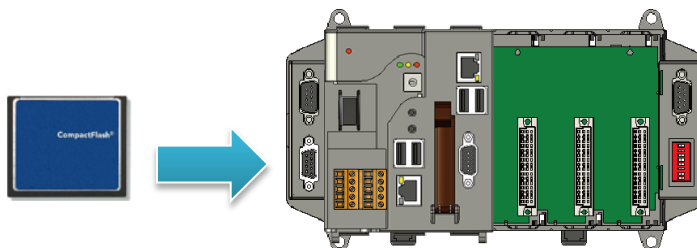

Step 4: Copy the file folder into C:\icpdas\, and then delete the older, existing file folder

10. XP-8000 Download Center

This chapter provides a brief introduction of the XP-8000 download center.

XP-8000 has a download center where you can access the latest version of the software, tools, demo programs, and related information.

The XP-8000 Download Center can be found separately at:

<http://www.icpdas.com/root/support/download/download.php>

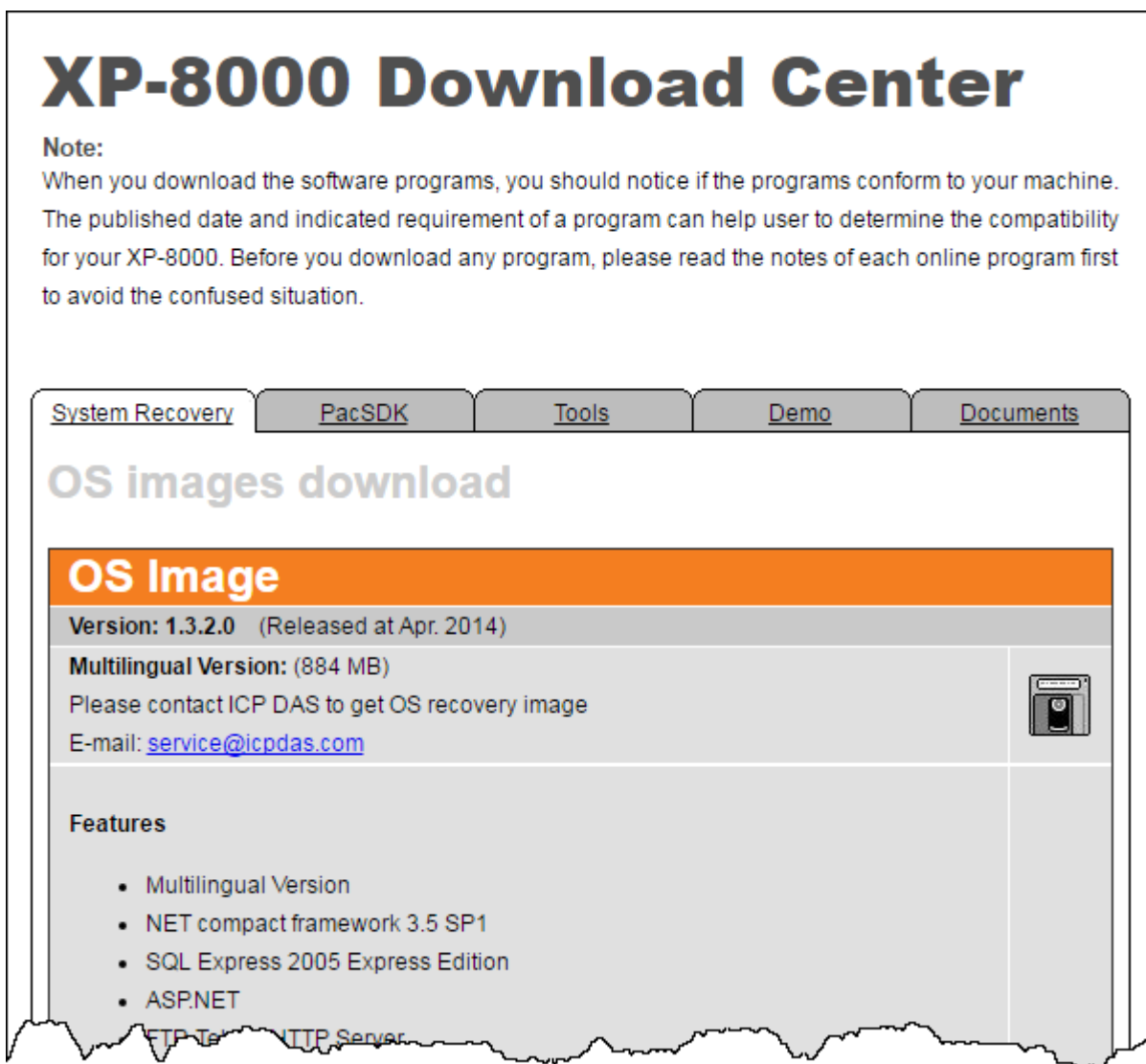

XP-8000 Download Center

Note:
When you download the software programs, you should notice if the programs conform to your machine. The published date and indicated requirement of a program can help user to determine the compatibility for your XP-8000. Before you download any program, please read the notes of each online program first to avoid the confused situation.

System Recovery | PacSDK | Tools | Demo | Documents

OS images download

OS Image	
Version: 1.3.2.0 (Released at Apr. 2014)	
Multilingual Version: (884 MB)	
Please contact ICP DAS to get OS recovery image E-mail: service@icpdas.com	
Features	
<ul style="list-style-type: none">• Multilingual Version• NET compact framework 3.5 SP1• SQL Express 2005 Express Edition• ASP.NET	

FTP Server | HTTP Server

Appendix

This chapter provides tips and a guided tour on using and maintaining the XP-8000.

A. I-8K Modules and I-87K Modules

This chapter provides a brief overview of the different between the I-8K series modules and I-87K series modules.

I-8K and I-87K modules provide the option to expand the local I/O to expansion I/O slots and the bus type for the modules can be either parallel (high profile I-8K series) or serial (high profile I-87K series).

The differences between the I-8K series modules and I-87K series modules are as follows.

Item	I-8K Series	I-87K Series
Microprocessor	No	Yes (8051)
Communication Interface	Parallel Bus	Serial Bus
Communication Speed	Fast	Slow
Latched DI Function	No	Yes
Counter Input (for digital input modules)	No	Yes (100 Hz)
Power-on Value	No	Yes
Safe Value	No	Yes
Programmable Slew-Rate for AO modules	No	Yes

B. Revision History

This chapter provides revision history information to this document.

The table below shows the revision history.

Revision	Date	Description
1.0.0	October 2016	Initial issue