

Quick Start for ECAT-2055

English / July,2016/ Ver 1.0

1 Shipping Package

This shipping package contains the following items

1 x ECAT-2000 module



1 x Quick Start Guide (This Document)



2 Connecting the Power and Host device

Switch on module and connect it to an EtherCAT network

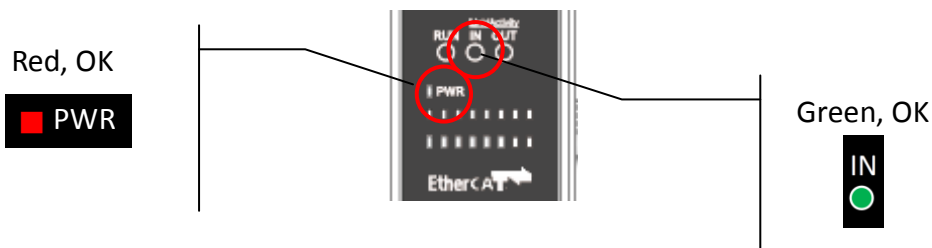
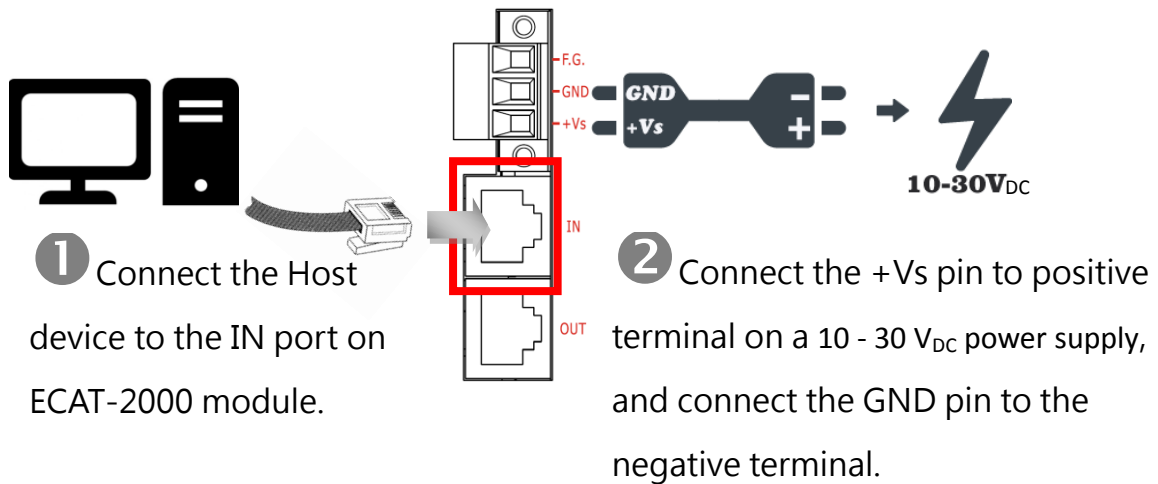

3 Search Modules



ESI file

The latest ESI file (ICPDAS ECAT-2000.xml) can be downloaded from ICP DAS website at

 http://ftp.icpdas.com/pub/cd/fieldbus_cd/ethercat/slave/ecat-2000/software/

Install the ESI file

Copy the “ICPDAS ECAT-2000.xml” file to the Master Tools installation folder, as indicated in the table below.

Software	Default Path
Beckhoff EtherCAT Configuration	C:\EtherCAT Configurator\EtherCAT
Beckhoff TwinCAT 3.X	C:\TwinCAT\3.x\Config\Io\EtherCAT
Beckhoff TwinCAT 2.X	C:\TwinCAT\Io\EtherCAT

Run the EtherCAT Master software (Beckhoff TwinCAT 2.X)

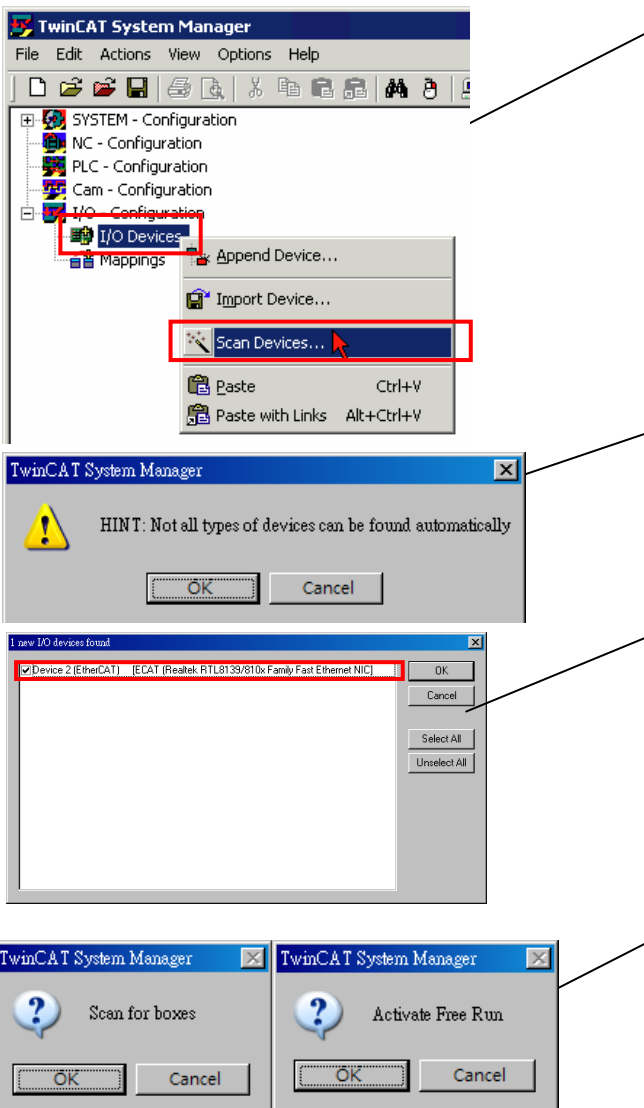

Switch on power

Execute the TwinCAT System Manager(Config mode)
I/O Devices-> Right click-> Scan Devices...

Click OK

Choose the correct network device which is
connected to ECAT-2000

Click Yes to start scanning and click Yes to
activate the free run mode for TwinCAT system
manager

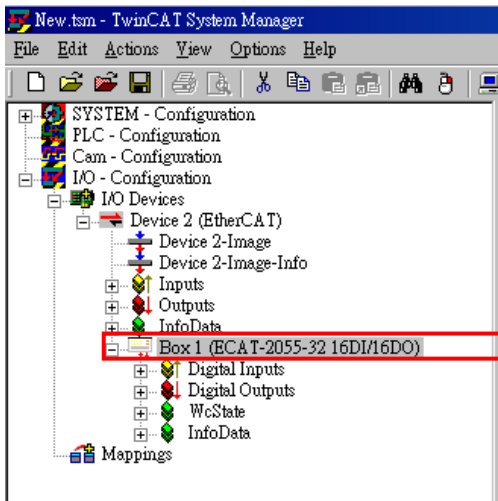

ECAT-2000 is now shown in the TwinCAT system Manager

4 Wiring to the connector

Wiring Tip

Connection the Wire

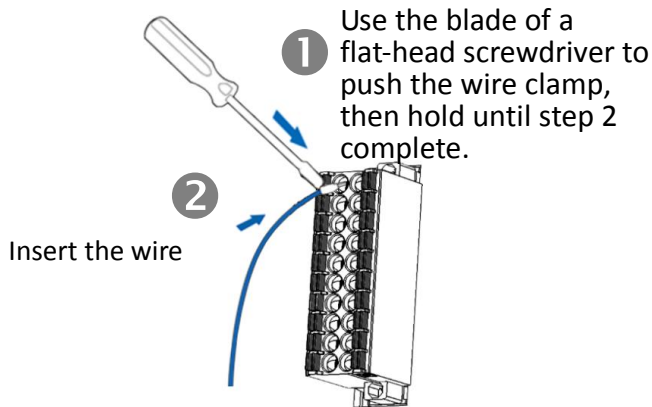

Removing the wire

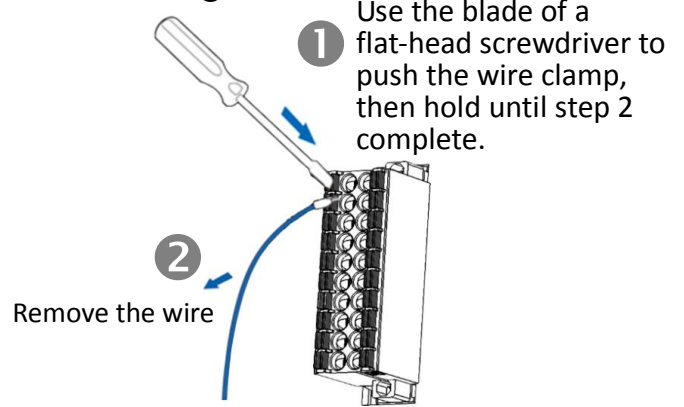

Wire Diagrams

Digital Input/Counter	Readback as 1 (+10 ~ +50 VDC)	Readback as 0 (Open or < 4VDC)
Sink		
Source		
Digital Input/Counter	Readback as 1 (Close to GND)	Readback as 0 (Open)
Dry		

Output Type	Readback as 1 (ON State)	Readback as 0 (OFF State)
Driver Relay		
Resistance Load		

Wiring the DO0 and DI0 Pins ③ Connect the GND on external power supply to the EXT.GND(Pin1)

① Connect the DO0(Pin3) to the DI0

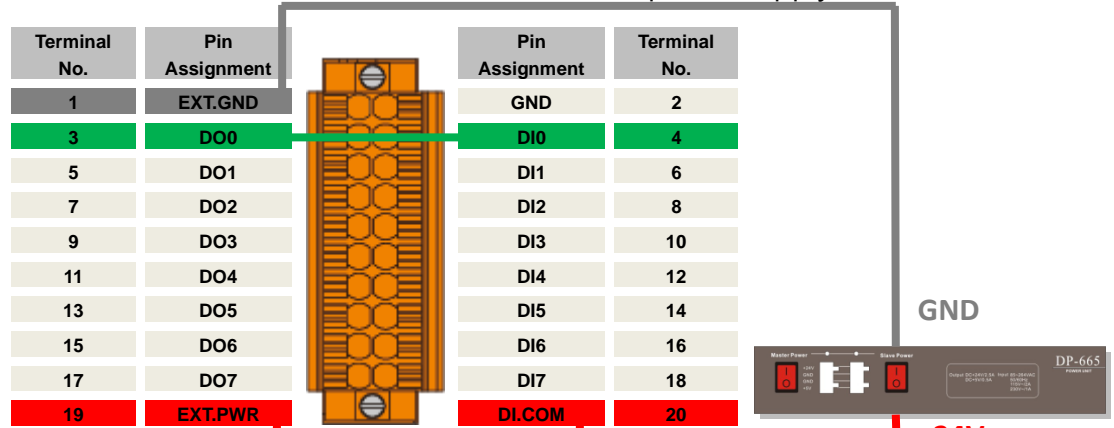

② Connect +24V external power supply to the DI.COM(Pin20) and EXT.PWR(pin19)

Verifying the DI and DO functionality

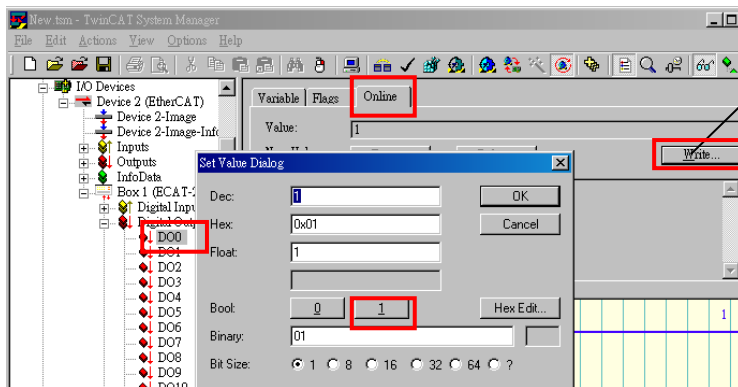

In the left-hand of the window, click on the DO0. In the right-hand of the windows, click the online. Click Write.

Click 1 (Configure DO0 to Logic1).

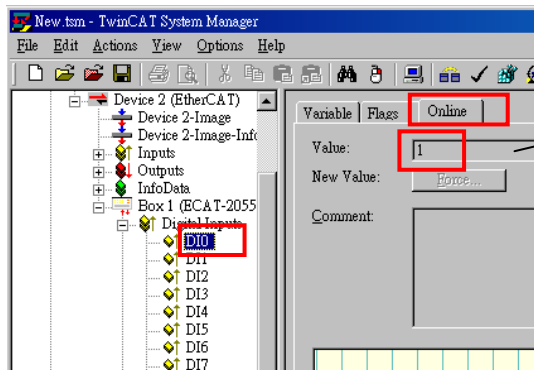

In the left-hand of the window, click DI0. In the right-hand of the windows, click the online. Check Value is 1.



Related Information

Product Page:

http://www.icpdas.com/root/product/solutions/industrial_communication/fieldbus/ethercat/io_module/ecat-2055.html

Documentation:

ftp://ftp.icpdas.com/pub/cd/fieldbus_cd/ethercat/slave/ecat-2000/

ESI file:

http://ftp.icpdas.com/pub/cd/fieldbus_cd/ethercat/slave/ecat-2000/software/

DP-665(Optional) Product Page:

http://www.icpdas.com/products/Accessories/power_supply/dp-665.htm