

3.5. tET/tPET Series Modules (IP based)

Introduction



The functionality of the tET/tPET series modules is almost the same as the PET-7000. The major difference is that the PET-7000 module supports user-defined web HMI interface and more connections, while the tET/tPET series supports fixed web interface for configuration, higher speed of 32-bit DI counters, frequency measurement, PWM digital output and low power consumption. Especially the tET/tPET series features tiny form factor and low channel count that are suitable in distributed I/O points applications, such as room control and monitor.

Push mode is a new way to transfer local DI status, immediately and automatically, to remote device or computer once the DI status changes. Without busy polling, push mode effectively reduces the network loading and improves the performance of the whole system. tET/tPET series supports both polling and push mode to transfer the I/O data over the network. No programming is required in the tET/tPET series, and the push mode can be easily enabled through the web configuration interface. The solution makes the user set up system easily and quickly, and the system work more efficient.

Applications

- Remote Maintenance
- Testing Equipment
- Building Automation
- Factory Automation
- Machine Automation

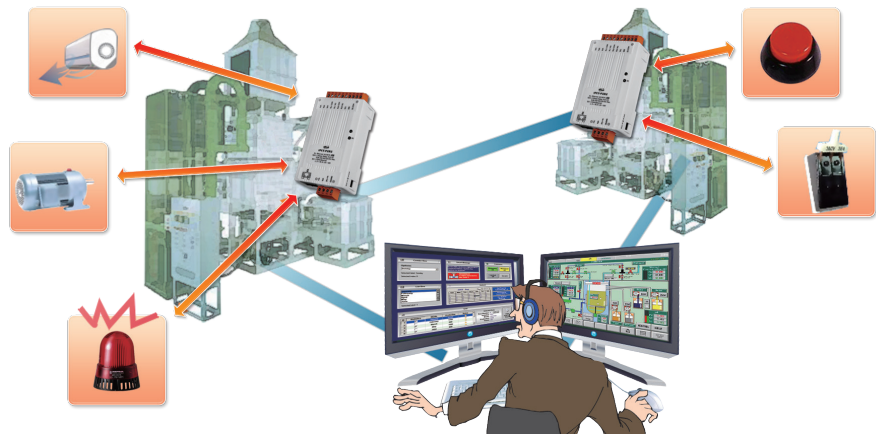

Features

1. DIO Pair-Connection (Mirror)

The tET/tPET series Ethernet I/O modules support various I/O types, like photo-isolated digital input, power relay, PhotoMOS relay, and open collector output. The module can be used to create DI to DO pair-connection (mirror) through the Ethernet. Once the configuration is completed, the modules can automatically read the local DI status and write to remote DO channels via the Modbus TCP protocol in the background.

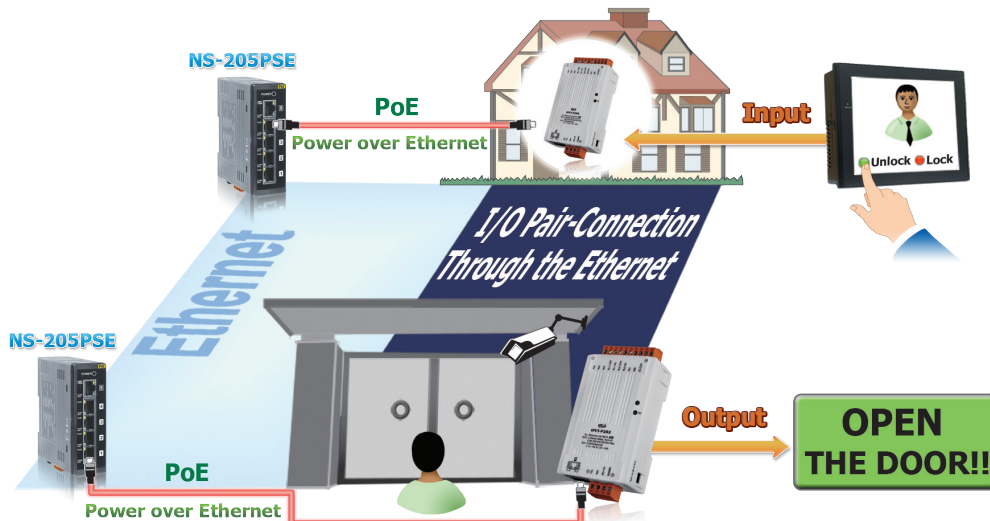

2. 32-bit High Speed Digital Counter

Polling the remote DI status back and then counting the ON/OFF changes in host computer may get quantity errors caused by communication delay. The tET/tPET series module has Built-in 32-bit counter function; it counts the DI ON/OFF changes in site to prevent counting errors caused by the communication latency. The 32-bit counter of the tET/tPET modules can count up to 4,294,967,295 and accept a frequency up to 3,500 Hz (without low pass filter), so it is suitable for more applications such as production counting, button or switch ON/OFF counting, event counting.

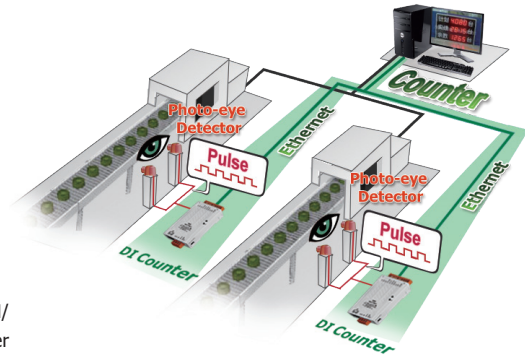

3. Frequency Measurement

The tET/tPET module also supports frequency measurement function; it counts the DI ON/OFF changes in a certain time period and then calculates the frequency automatically. Rather than polling remote DI status back and then computing the frequency in the host PC, our module can directly count out the frequency in site. This reduces the frequency errors caused by communication latency between two ends, and also reduces the network loadings. In order to applying for more applications, this module provides 3 scan modes (0.1s, 1s and single-pulse) and 4 moving average levels for user to select the best way in their applications. This feature can be used for rotation and speed measurements... etc.

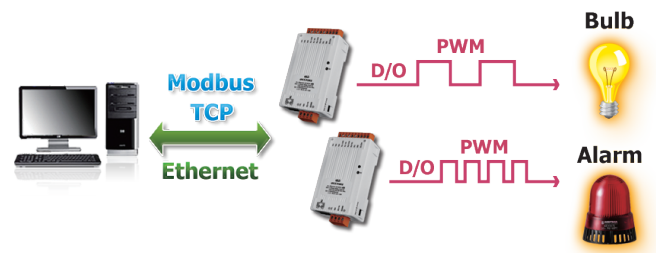

4. PWM (Pulse Width Modulation) Digital Output

The DOs on the tET/tPET series provide PWM (pulse width modulation) function that can be used in applications such as alarm light, flash light controls. Once the configuration is finished, the module will automatically and continuously switch the DO output ON and OFF. This removes the busy control by remote host and also reduces the network loadings. Users can set different frequency and duty cycle for the PWM function in each digital output channel. In addition, the DO channels can work independently or simultaneously. This function reduces the complexity of the control system and enhances the timing accuracy of pulse output.

5. Easy Network Configuration

DHCP minimizes configuration errors caused by manual IP address configuration, such as address conflicts caused by the assignment of an IP address to more than one computer or device at the same time. The tET/tPET series module supports the DHCP client function, which allows the tET/tPET to easily obtain the necessary TCP/IP configuration information from a DHCP server. The module also contains a UDP responder that transmits its IP address information to a UDP search from the eSearch utility program, making local management more efficient.

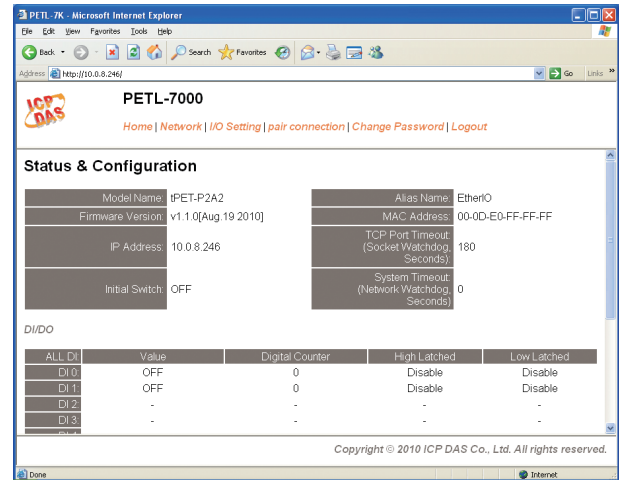

The series of Ethernet I/O modules features a powerful 32-bit MCU to enable efficient handling of network traffic. It also has a Built-in web server that provides an intuitive web management interface to allow users to modify the settings of the module including DHCP/Static IP, gateway and mask.

6. Dual Watchdog with Power-on and Safe Value

The module provides dual watchdog: module watchdog (hardware function) and host watchdog (software function). The module watchdog automatically resets the module if the built-in firmware is operating abnormally, while the host watchdog sets the digital output with predefined safe-value when there is no communication between the module and the host (PC or PLC) for a period of time (watchdog timeout). The dual watchdog is an important feature that ensures the module operates continuously, even in harsh environments.

7. PoE (Power over Ethernet)

The tPET series module offers true IEEE 802.3af-compliant (classification, Class 1) Power over Ethernet (PoE) using a standard category 5 Ethernet cable to receive power from a PoE switch such as the NS-205PSE. If there is no PoE switch on site, the module will also accept power input from a DC adapter.

8. Low Power Consumption



The tET/tPET series is designed for ultra-low power consumption, reducing hidden costs from increasing fuel and electricity prices, especially when you have a huge amount of devices installed. Reducing the amount of electricity consumed by choosing energy-efficient equipment can have a positive impact on maintaining a green environment. The module is equipped with removable terminal block connectors to allow easy wiring. For maximum space savings, the tET/tPET series is offered in an amazing tiny form-factor; this makes them can be easily installed in anywhere, even directly embedded into a machine.

1 Polling: Masters poll tET/tPET DIO modules

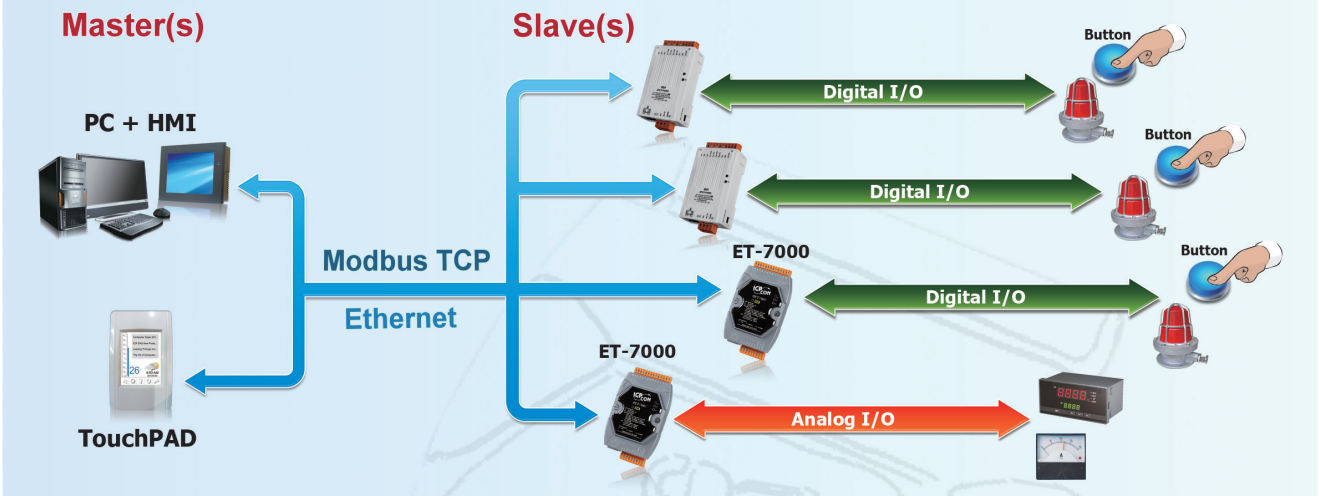

2 Push: tET/tPET module pushes DI to remote DO

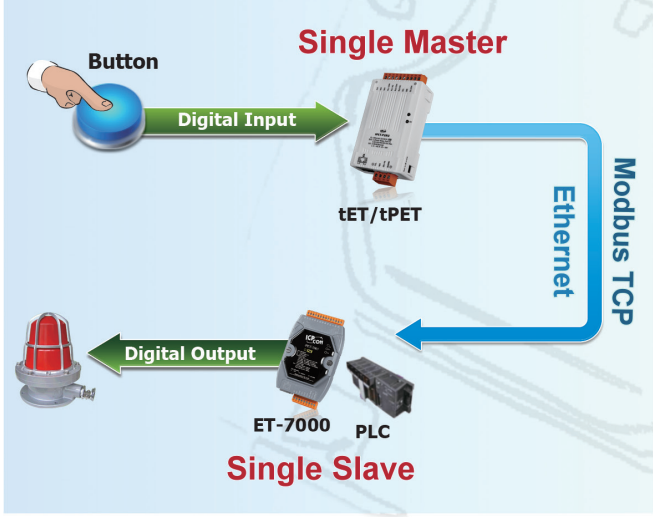

3 Push: tET/tPET modules push DI to remote DO

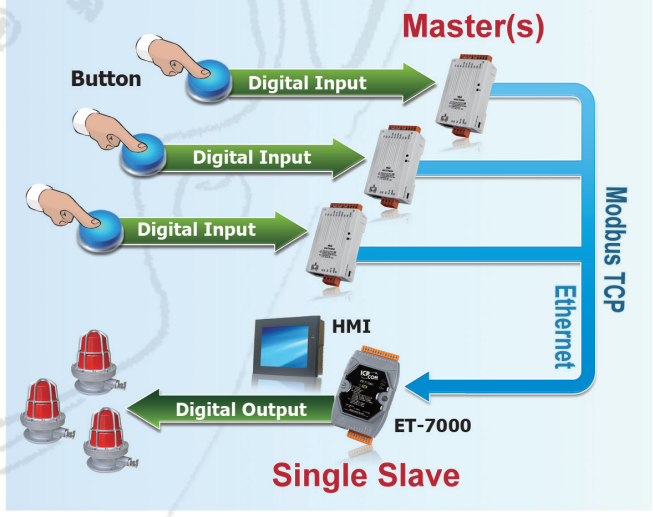

4 Polling: tET/tPET DIO pair-connection

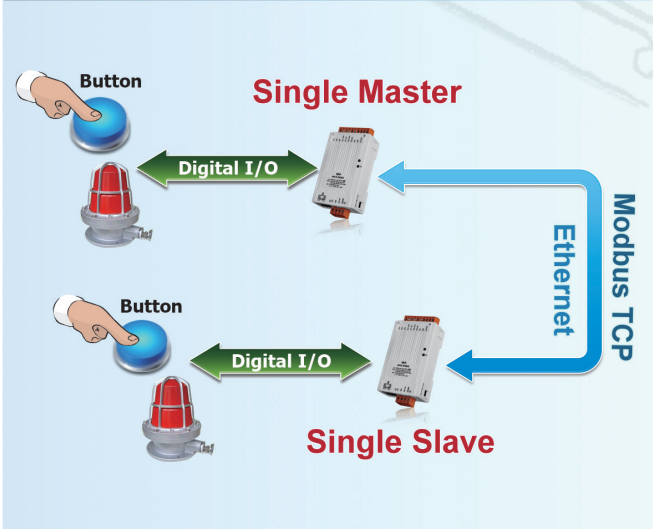

5 Polling: tET/tPET modules poll remote DIO

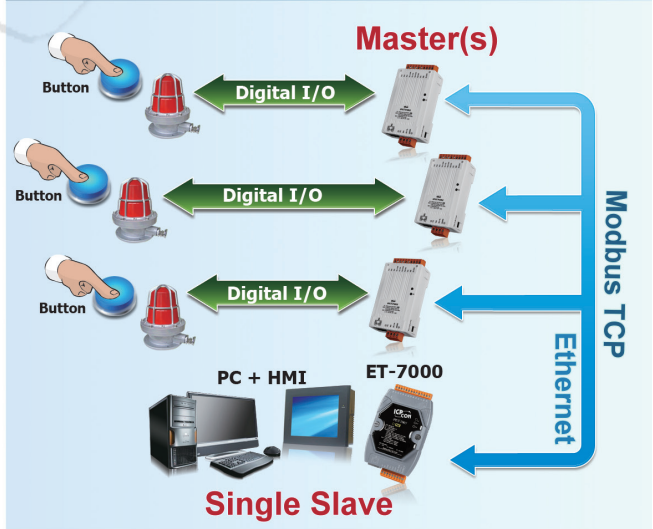

Selection Guide

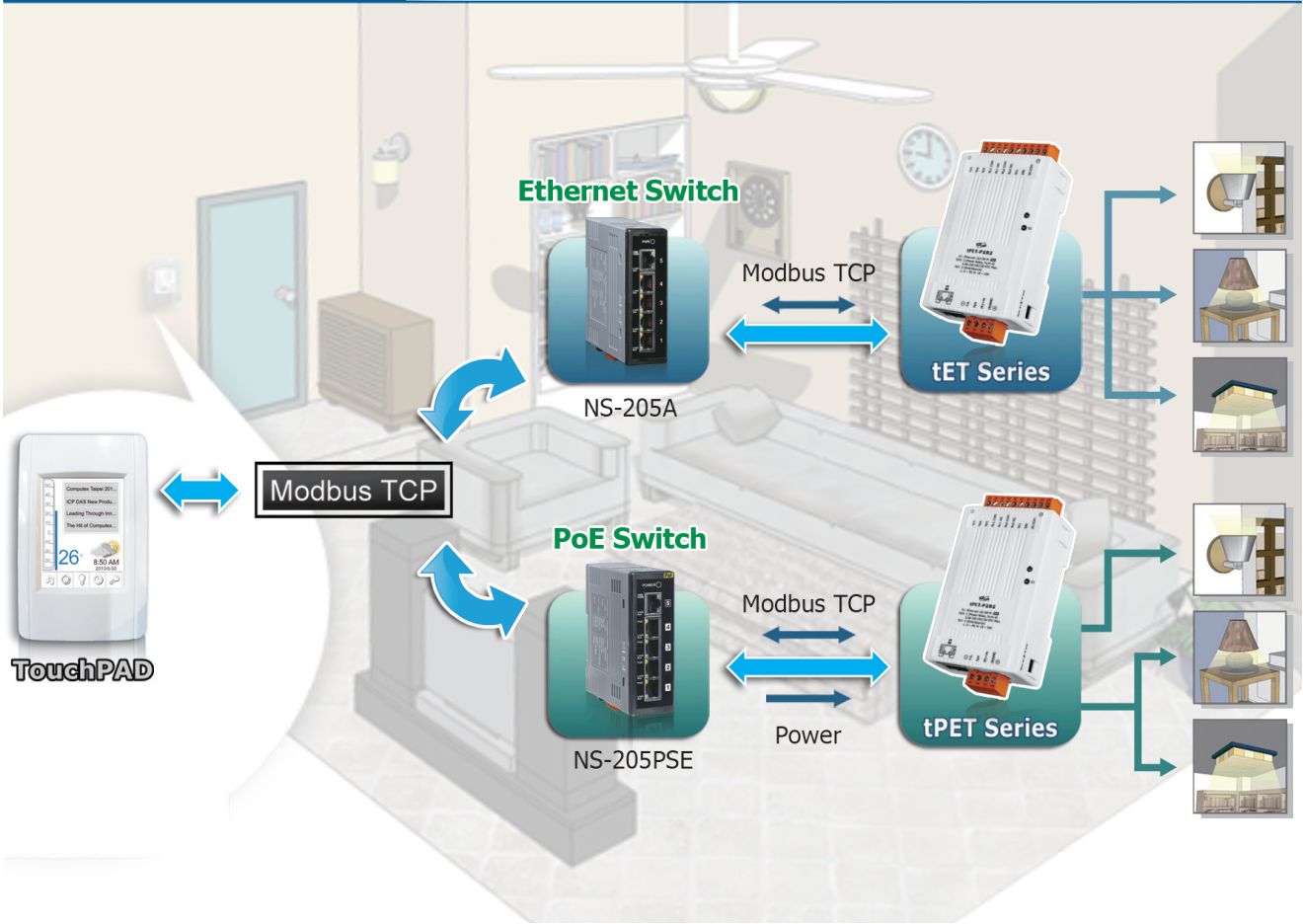

3
5

Ethernet I/O Products

tET/tPET Selection Guide

Digital I/O								
Model Name		DI			DO			
	Ethernet	PoE	Channel	Contact	Sink/Source	Channel	Type	Sink/Source
	tET-P6	tPET-P6	6	Wet	Sink/Source	-	-	-
NEW	tET-PD6	tPET-PD6	6	Dry	Source	-	-	-
	tET-C4	tPET-C4	-	-	-	4	Open Collector	Sink/NPN
	tET-A4	tPET-A4	-	-	-	4	Open Emitter	Source/PNP
	tET-P2C2	tPET-P2C2	2	Wet	Sink/Source	2	Open Collector	Sink/NPN
	tET-P2A2	tPET-P2A2	2	Wet	Sink/Source	2	Open Emitter	Source/PNP

Relay Output/Digital Input									
Model Name		Relay Output					DI		
	Ethernet	PoE	Channel	Relay	Type	Max. Load Current	Channel	Contact	Sink/Source
NEW	tET-P2POR2	tPET-P2POR2	2	PhotoMOS Relay	Form A	1.0 A/channel	2	Wet	Sink/Source
NEW	tET-PD2POR2	tPET-PD2POR2	2	PhotoMOS Relay	Form A	1.0 A/channel	2	Dry	Source
	tET-P2R2	tPET-P2R2	2	Power Relay	Form A (SPST N.O.)	5.0 A/channel	2	Wet	Sink/Source
NEW	tET-PD2R1	tPET-PD2R1	1	Power Relay	Form A (SPST N.O.)	5.0 A/channel	2	Dry	Source



Features

- Cost-effective Tiny Ethernet I/O Modules (Modbus TCP/UDP)
- 10/100 Base-TX Ethernet, RJ-45 x1 (Auto-negotiating, Auto MDI/MDIX, LED Indicators)
- Contains a Powerful 32-bit MCU
- Includes Redundant Power Inputs: PoE and DC Input
- Supports UDP Responder for Device Discovery
- Supports Web Configuration and Firmware Update Via Ethernet
- Supports Latched DI, 32-bit DI Counters and Frequency Measurement
- Supports I/O Pair-connection Through the Ethernet
- Dual-watchdog with Power-on and Safe Value
- Made from Fire-retardant Materials (UL94-V0 Level)
- Low Power Consumption









System Specifications

Model Name	tET Series	tPET Series
Software		
Built-in Web Server	Yes	
I/O Pair Connection	Yes, Supports Polling and Push modes	
Communication		
Ethernet Port	10/100 Base-TX, 8-Pin RJ-45 x1 (Auto-negotiating, Auto-MDI/MDIX, LED indicators)	
Protocol	Modbus TCP, Modbus UDP, HTTP, DHCP, BOOTP and TFTP	
Security	IP filter (whitelist) and Password (web)	
Dual Watchdog	Yes, Module (2 seconds) and Host (programmable)	
LED Indicators		
S1	System Running (Red)	PoE (Green)
E1	Link/Act (Green), 10/100 M (Yellow)	
EMS Protection		
ESD (IEC 61000-4-2)	±4 kV Contact for Each Terminal	
EFT (IEC 61000-4-4)	±2 kV for Power and Signal	
Mechanical		
Dimensions (W x L x H)	52 mm x 98 mm x 27 mm	
Installation	DIN-Rail	
Power Requirements		
Powered from Terminal Block	Yes, +12 ~ 48 Vdc (non-regulated)	
Powered from PoE	-	Yes, IEEE 802.3af, Class 1
Consumption	0.04 A @ 24 Vdc Max. for tET-P2R2	0.03 A @ 48 Vdc Max. for tPET-P2R2
Environment		
Operating Temperature	-25 ~ +75°C	
Storage Temperature	-30 ~ +80°C	
Humidity	10 ~ 90% RH, Non-condensing	





I/O Specifications

Digital Input/Output Series

Model Name	tET-C4 tPET-C4	tET-A4 tPET-A4
Pictures		
Digital Output		
Channels	4	
Type	Open Collector	Open Emitter
Sink/Source (NPN/PNP)	Sink	Source
Load Voltage	+5 Vdc ~ +30 Vdc	+10 Vdc ~ +40 Vdc
Max. Load Current	100 mA/channel	650 mA/channel
PWM	100 Hz Max. (High/Low duty cycle range = 5 ~ 65,535 ms)	
Overvoltage Protection	+60 Vdc	+48 Vdc
Short Circuit Protection	-	Yes
Isolation	3750 Vrms	

Model Name	tET-PD6 tPET-PD6	tET-P6 tPET-P6	tET-P2C2 tPET-P2C2	tET-P2A2 tPET-P2A2
Pictures	 NEW			
Digital Input				
Channels	6	6	2	
Contact	Dry Contact		Wet Contact	
Sink/Source (NPN/PNP)	Source		Sink/Source	
On Voltage Level	Close to GND		+10 VDC ~ +50 VDC	
Off Voltage Level	Open		+4 VDC (Max.)	
Input Impedance	-		10 kΩ	
Counters	Max. Count			
	4,294,967,285 (32 bits)			
Frequency Measurement	Min. Pulse Width			
	0.15 ms			
Frequency Measurement	3.5 kHz (without filter)			
Overvoltage Protection	-		+70 Vdc	
Isolation	3750 Vrms			
Effective Distance	500 M (Max.)		-	
Digital Output				
Channels			2	
Type			Open Collector	Open Emitter
Sink/Source (NPN/PNP)			Sink	Source
Load Voltage			+5 Vdc ~ +30 Vdc	+10 Vdc ~ +40 Vdc
Max. Load Current			100 mA/channel	650 mA/channel
PWM			100 Hz Max. (High/Low duty cycle range = 5 ~ 65,535 ms)	
Overvoltage Protection			+60 VDC	+48 VDC
Short Circuit Protection			-	Yes
Isolation			3750 Vrms	

Digital Input/Relay Output Series

Model Name	tET-PD2POR2 tPET-PD2POR2	tET-P2POR2 tPET-P2POR2	tET-PD2R1 tPET-PD2R1	tET-P2R2 tPET-P2R2
Pictures	 NEW	 NEW	 NEW	
PhotoMOS/Power Relay Output				
Channels	2		1	2
Type	PhotoMOS Relay, Form A (SPST N.O.)		Power Relay, Form A (SPST N.O.)	
Load Voltage	60 Vdc/VAc		250 VAc/30 Vdc	
Max. Load Current	60 V/1.0 A (Operating Temperature -25 ~ -40°C)		5.0 A/channel at 25°C	
	60 V/0.8 A (Operating Temperature +40 ~ +60°C)			
	60 V/0.7 A (Operating Temperature +60 ~ +75°C)			
Operate Time	1.3 ms (Typical)		6 ms	
Release Time	0.1 ms (Typical)		3 ms	
PWM	100 Hz Max. (High/Low duty cycle range = 5 ~ 65,535 ms)		50 Hz Max. (High/Low duty cycle range = 10 ~ 65,535 ms)	
Electrical Endurance (Resistive load)	VED	Long Life and No Spike		5 A 250 VAc 30,000 ops (10 ops/minute) at 75°C
	UL			5 A 30 Vdc 70,000 ops (10 ops/minute) at 75°C
				5 A 250 VAc/30 Vdc 6,000 ops
				3 A 250 VAc/30 Vdc 100,000 ops
Mechanical Endurance	-		20,000,000 ops. At no load (300 ops./ minute)	
Isolation	3000 Vrms			

Model Name	tET-PD2POR2 tPET-PD2POR2	tET-PD2R1 tPET-PD2R1	tET-P2POR2 tPET-P2POR2	tET-P2R2 tPET-P2R2
Digital Input				
Channels	2		2	
Contact	Dry Contact		Wet Contact	
Sink/Source (NPN/PNP)	Source		Sink/Source	
On Voltage Level	Close to GND		+10 Vdc ~ +50 Vdc	
Off Voltage Level	Open		+4 Vdc Max.	
Input Impedance	-		10 kΩ	
Counters	Max. Count	4,294,967,285 (32 bits)		
	Min. Pulse Width	0.15 ms		
Frequency Measurement	3.5 kHz (without filter)			
Overvoltage Protection	-		+70 Vdc	
Isolation	3750 Vrms			
Effective Distance	500 M (Max.)		-	

Note: When inductive loads are connected to the relays, a large counter electromotive force may occur when the relay actuates because of the energy stored in the load. These flyback voltages can severely damage the relay contacts and greatly shorten the relay life. Limit these flyback voltages at your inductive load by installing a flyback diode for DC loads or a metal oxide varistor for AC loads.

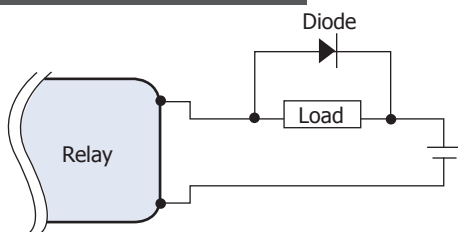
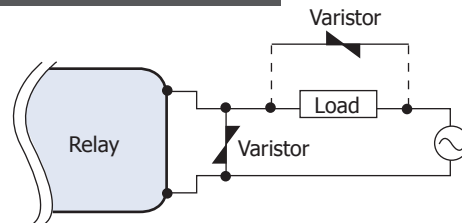
for DC loads

for AC loads

Varistor Selection

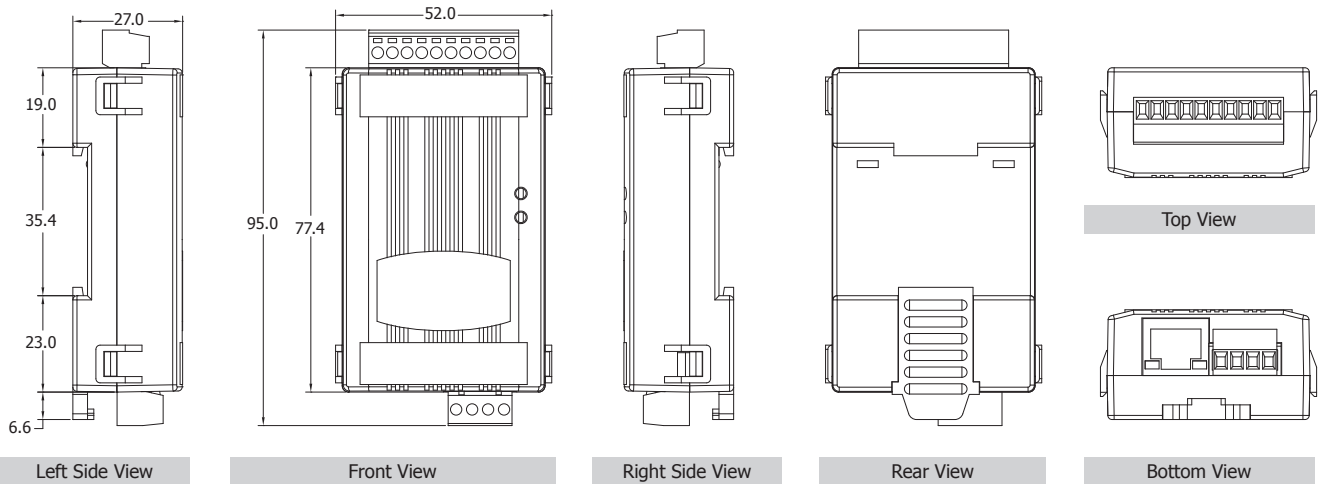
Operating Voltage	Varistor Voltage	Max. Peak Current
100 ~ 120 VAc	240 ~ 270 VAc	> 1000 A
200 ~ 240 VAc	440 ~ 470 VAc	> 1000 A







■ Dimensions (Units: mm)



■ Ordering Information

tTET Series	
tTET-P6 CR	Tiny Ethernet module with 6-channel DI (Wet Contact) (RoHS)
tTET-PD6 CR	Tiny Ethernet module with 6-channel DI (Dry Contact) (RoHS)
tTET-C4 CR	Tiny Ethernet module with 4-channel DO (NPN, Sink) (RoHS)
tTET-A4 CR	Tiny Ethernet module with 4-channel DO (PNP, Source) (RoHS)
tTET-P2C2 CR	Tiny Ethernet module with 2-channel DI and 2-channel DO (NPN, Sink) (RoHS)
tTET-P2A2 CR	Tiny Ethernet module with 2-channel DI and 2-channel DO (PNP, Source) (RoHS)
tTET-P2POR2 CR	Tiny Ethernet module with 2-channel DI (Wet Contact) and 2-channel Form A PhotoMos relay (RoHS)
tTET-PD2POR2 CR	Tiny Ethernet module with 2-channel DI (Dry Contact) and 2-channel Form A PhotoMos relay (RoHS)
tTET-P2R2 CR	Tiny Ethernet module with 2-channel DI (Wet Contact) and 2-channel Form A relay (RoHS)
tTET-PD2R1 CR	Tiny Ethernet module with 2-channel DI (Dry Contact) and 1-channel Form A relay (RoHS)
tPET Series	
tPET-P6 CR	Tiny Ethernet module with PoE, and 6-channel DI (Wet Contact) (RoHS)
tPET-PD6 CR	Tiny Ethernet module with PoE, and 6-channel DI (Dry Contact) (RoHS)
tPET-C4 CR	Tiny Ethernet module with PoE, and 4-channel DO (NPN, Sink) (RoHS)
tPET-A4 CR	Tiny Ethernet module with PoE, and 4-channel DO (PNP, Source) (RoHS)
tPET-P2C2 CR	Tiny Ethernet module with PoE, 2-channel DI and 2-channel DO (NPN, Sink) (RoHS)
tPET-P2A2 CR	Tiny Ethernet module with PoE, 2-channel DI and 2-channel DO (PNP, Source) (RoHS)
tPET-P2POR2 CR	Tiny Ethernet module with PoE, 2-channel DI (Wet Contact) and 2-channel Form A PhotoMos relay (RoHS)
tPET-PD2POR2 CR	Tiny Ethernet module with PoE, 2-channel DI (Dry Contact) and 2-channel Form A PhotoMos relay (RoHS)
tPET-P2R2 CR	Tiny Ethernet module with PoE, 2-channel DI (Wet Contact) and 2-channel Form A power relay (RoHS)
tPET-PD2R1 CR	Tiny Ethernet module with PoE, 2-channel DI (Dry Contact) and 1-channel Form A power relay (RoHS)

■ Related Products

	NS-205A CR	Unmanaged 5-port Industrial Ethernet Switch with Power Input +12 Vdc ~ +56 Vdc (RoHS)
	NS-205PSE CR	Unmanaged Ethernet Switch with 4 PoE Ports and 1 RJ-45 Uplink (RoHS)
	NS-205PSE-24V CR	Unmanaged 5-Port 10/100 Mbps PoE (PSE) Ethernet Switch; 24 Vdc Input (RoHS)
	DIN-KA52F CR	24 V/1.04 A, 25 W Power Supply with DIN-Rail Mounting (RoHS)
	DIN-KA52F-48 CR	48 V/0.52 A, 25 W Power Supply with Din-Rail Mounting (RoHS, for NS-205PSE)
	GPSU06U-6	24 V/0.25 A (max) Power Supply