



WP-8000-CE7 Series User Manual

V1.0.2, September 2020



WP-8121-CE7/WP-8421-CE7/WP-8821-CE7

Written by Sean Hsu

Edited by Anna Huang

Warranty

All products manufactured by ICP DAS are under warranty regarding defective materials for a period of one year, beginning from the date of delivery to the original purchaser.

Warning

ICP DAS assumes no liability for any damage resulting from the use of this product. ICP DAS reserves the right to change this manual at any time without notice. The information furnished by ICP DAS is believed to be accurate and reliable. However, no responsibility is assumed by ICP DAS for its use, not for any infringements of patents or other rights of third parties resulting from its use.

Copyright

Copyright © 2020 by ICP DAS Co., Ltd. All rights are reserved.

Trademark

The names used for identification only may be registered trademarks of their respective companies.

Contact US

If you have any problem, please feel free to contact us.

You can count on us for quick response.

Email: service@icpdas.com

Contents

CONTENTS.....	3
1. INTRODUCTION	6
1.1. Features.....	7
1.2. Specifications	8
1.3. Overview	10
1.4. Dimensions.....	17
1.5. Companion CD.....	19
2. GETTING STARTED.....	20
2.1. Mounting the WP-8000-CE7	21
2.2. Deploying a Basic WP-8000-CE7 System	24
2.3. Installing the I/O Modules.....	26
2.4. Configuring the Boot Mode.....	28
2.5. Changing the User Interface Language	30
2.6. Using PAC Utility to Manage the WP-8000-CE7	32
2.7. Using DCON Utility Pro Configure I/O Modules	33
3. TOOLS AND TASKS.....	36
3.1. PAC Utility.....	37
3.1.1. Menu Bar – File.....	38
3.1.2. Menu Bar – Help.....	39
3.1.3. Property Tab - General.....	40
3.1.4. Property Tab – General2.....	42
3.1.5. Property Tab – Display	43
3.1.6. Property Tab – IP Config	44
3.1.7. Property Tab – Network.....	45
3.1.8. Property Tab – Device Information.....	48
3.1.9. Property Tab – Auto Execution	49
3.1.10. Property Tab – Rotary Execution	50
3.2. DCON Utility Pro.....	51
3.3. TaskMgr.....	52
3.4. VCEP	53
3.5. Remote_Display	54
3.6. SendToCOM.....	55
3.7. RegEdit	56
3.8. ISQLW35	57
3.9. INotepad.....	58

4.	YOUR FIRST WP-8000-CE7 PROGRAM.....	59
4.1.	Setting up the Development Environment.....	59
4.1.1.	Preparing the Development Tools and Programming Languages	60
4.1.2.	Installing the WP-8000-CE7 SDK.....	61
4.1.3.	Setting up the Global Compiler Settings (for Visual C++)	62
4.2.	First WP-8000-CE7 Program in VB.NET	64
4.2.1.	Create a new project	65
4.2.2.	Specify the path of the PAC reference.....	68
4.2.3.	Add the control to the form	70
4.2.4.	Add the event handling for the control.....	72
4.2.5.	Upload the application to WP-8000-CE7.....	73
4.2.6.	Execute the application on WP-8000-CE7	75
4.3.	First WP-8000-CE7 Program in Visual C#	76
4.3.1.	Create a new project	77
4.3.2.	Specify the path of the PAC reference.....	80
4.3.3.	Add the control to the form	82
4.3.4.	Add the event handling for the control.....	84
4.3.5.	Upload the application to WP-8000-CE7.....	85
4.3.6.	Execute the application on WP-8000-CE7	87
4.4.	First WP-8000-CE7 Program in Visual C++	88
4.4.1.	Create a new project	89
4.4.2.	Configure the Platform	94
4.4.3.	Specify the Libraries of the PAC SDK.....	95
4.4.4.	Add the control to the form	97
4.4.5.	Add the event handling for the control.....	100
4.4.6.	Upload the application to WP-8000-CE7.....	102
4.4.7.	Execute the application on WP-8000-CE7	104
5.	I/O EXPANSION MODULES AND SDKS SELECTION	105
6.	API RESOURCES AND DEMO REFERENCES	109
6.1.	PAC Standard APIs for System Operation.....	110
6.1.1.	VB.NET Demos for PAC Standard APIs.....	111
6.1.2.	C# Demos for PAC Standard APIs.....	112
6.1.3.	Visual C++ Demos for PAC Standard APIs	113
6.2.	PAC Standard APIs for PAC Expansion I/O	114
6.2.1.	VB.NET Demos for PAC Expansion I/O.....	115
6.2.2.	C# Demos for PAC Expansion I/O.....	117
6.2.3.	Visual C++ Demos for PAC Expansion I/O	119
7.	WP-8000-CE7 UPDATES	121

7.1.	OS Updates.....	122
7.1.1.	OS Updates from Eshell	123
7.1.2.	OS updates from microSD	126
7.2.	SDK Updates.....	129
7.2.1.	SDK Updates for VB.NET or C#	130
7.2.2.	SDK Updates for VB.NET or Visual C++	131
8.	DOWNLOAD CENTER.....	132
TIPS – HOW TO.....		133
A.	How to Online Debug the WP-8000-CE7 Program	134
B.	How to Automatically Synchronize WP-8000-CE7 Clock with an Internet Time Server	139
C.	How to Control the User Account Control in WP-8000-CE7.....	141
C.1.	How to Create a User Account.....	142
C.2.	How to Telnet to Remote Login the WinPAC from PC.....	144
C.3.	How to Remove a User Account from the Login List	146
D.	How to change the battery.....	147
E.	How to Using the Practical Functions of the 3G/4G I/O Module	149
E.1.	How to Auto Dial 3G/4G GPRS network and redial when the network disconnected	149
E.2.	How to Use the SMS Function and Get the GPS Data	150
E.3.	How to Synchronize the System Time by GPS Data	151
F.	Application of RS-485 Network	152
F.1.	Basic RS-485 Network.....	152
F.2.	Daisy Chain RS-485 Network.....	153
F.3.	Star Type RS-485 Network	154
F.4.	Random RS-485 Network.....	156
F.5.	Master/Slaves Settings.....	157
G.	Revision History	162

1. Introduction

This chapter provides an overview of the WP-8000-CE7 and its components, and introduces the fundamental concepts for user familiar with the WP-8000-CE7.

The WP-8000-CE7 is the new generation Windows CE 7.0 based PAC (Programmable Automation Controller) of ICP DAS. Each WP-8000-CE7 is equipped with a Cortex-A8 (1.0 GHz) CPU running a Windows CE 7.0 operating system, a variant of input/output ports (VGA, USB, Ethernet, RS-232/485), and 1/4/8 expansion I/O slots that can be used to integrate high performance I-8K (parallel-type) and I-87K (serial-type) series I/O modules.

Its operating system, Windows CE 7.0, has many advantages, including hard real-time capability, small core size, fast boot speed, interrupt handling at a deeper level, achievable deterministic control and low cost. Using Windows CE 7.0 in the WP-8000-CE7 gives it the ability to run PC-based Control software such as Visual Basic.NET, Visual C#, Visual C++, SCADA software, Soft PLC and etc.

1.1. Features

The WP-8000-CE7 offers the most comprehensive configuration to meet specific application requirements. The following list shows the hardware and software features designed to simplify installation, configuration and application.

Hardware Features

- Powerful CPU module
- Cortex-A8 1.0 GHz CPU
- Memory Size:
 - SDRAM (512 MB)
 - Flash (256 MB)
 - microSD card (support up to 32 GB)
- VGA Port x 1, USB 2.0 port x 2, Serial port (RS-232/RS-485) x 4
- 64-bit Hardware Serial Number
- Dual Watchdog Timers
- Dual Ethernet Ports (10 M/100 M/1000 M)
- Redundant Power Input
- Operating Temperature: -25 ~ +75 °C

Software Features

- Windows Embedded Compact 7.0
- JavaScript and VBScript
- SQL Compact Edition 3.5
- .NET Compact Framework 3.5
- Remote Display
- Rich Software Solution – SDK for Microsoft Visual Studio 2008

1.2. Specifications

The table below summarizes the specifications of the WP-8000-CE7.

Models	WP-8121-CE7	WP-8421-CE7	WP-8821-CE7
System Software			
OS	Windows CE 7.0		
.Net Compact Framework	3.5		
Embedded Service	FTP Server, Web Server (Supports VB script, JAVA script), Embedded SQL Server		
SDK Provided	DII for VC, DII for Visual Studio.Net 2008		
Multilanguage Support	English, German, French, Spanish, Russian, Italian, Korean, Simplified Chinese, Traditional Chinese		
CPU Module			
CPU	Cortex-A8 (1.0 GHz)		
SDRAM	512 MB (DDR3)		
Flash	256 MB		
MRAM	128 KB		
EEPROM	16 KB		
microSD	microSD socket with one microSD card		
RTC (Real Time Clock)	Provide second, minute, hour, date, day of week, month, year		
64-bit Hardware Serial Number	Yes, for software copy protection		
Dual Watchdog Timers	Yes (0.8 second)		
Programmable LED Indicator	1		
Rotary Switch	Yes (0 ~ 9)		
DIP Switch	-	Yes (8 bits)	
VGA & Communication Ports			
VGA Resolution	800 x 600, 1024 x 768		
Dual Ethernet Ports	RJ-45, 10 M/100 M/1000 M Base-TX		
USB	USB 2.0 x 2		
COM 0	Internal communication with the high profile I-87K series modules in slots		
COM 1	RS-232 (RxD, TxD and GND); Non-isolation		

Models	WP-8121-CE7	WP-8421-CE7	WP-8821-CE7
VGA & Communication Ports			
COM 2	RS-485 (Data+, Data-);self-tuner ASIC inside; 3000 V _{DC} isolated		
COM 3	-	RS-232/485 (RxD, TxD, CTS, RTS and GND for RS-232; Data+, Data- for RS-485); Non-isolation	
COM 4	-	RS-232 (RXD, TXD, CTS, RTS, DSR, DTR, CD, RI and GND); Non-isolation	
Number of I/O slots	1	4	8
Mechanical			
Dimensions (W x H x D)	95 x 132 x 111	231 x 132 x 111	355 x 132 x 111
Installation	DIN-Rail or Wall Mounting		
Environmental			
Operating Temperature	-25 °C ~ +75 °C		
Storage Temperature	-30 °C ~ + 80 °C		
Ambient Relative Humidity	10 % ~ 90 % RH (non-condensing)		
Environmental			
Input Range	+10 V _{DC} ~ +30 V _{DC}		
Redundant Power Inputs	Yes		
Isolation	1 kV		
Capacity	1.0A, 5V supply to CPU and backplane, 0.6A, 5V supply to I/O expansion slots, total 8 W	1.1A, 5V supply to CPU and backplane, 4.9A, 5V supply to I/O expansion slots, total 30 W	1.2A, 5V supply to CPU and backplane, 4.8A, 5V supply to I/O expansion slots, total 30 W
Consumption	7.3 W (0.3 A @ 24 V _{DC})	9.1 W (0.38 A @ 24 V _{DC})	9.6 W (0.4 A @ 24 V _{DC})

1.3. Overview

Here is an overview of the components and its descriptions.

WP-8121-CE7

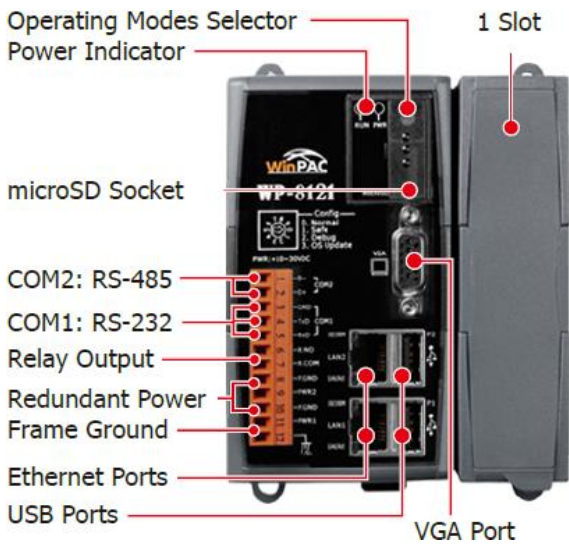

WP-8421-CE7

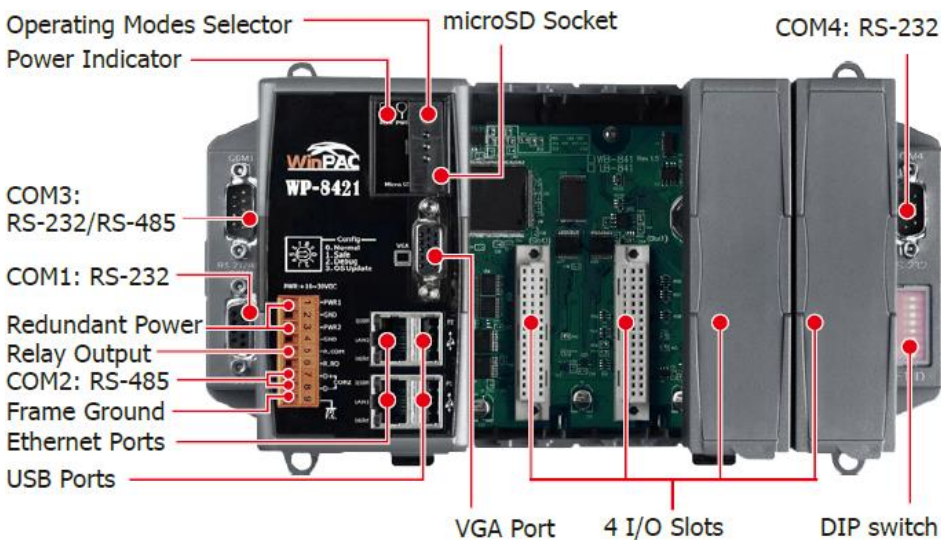

WP-8821-CE7

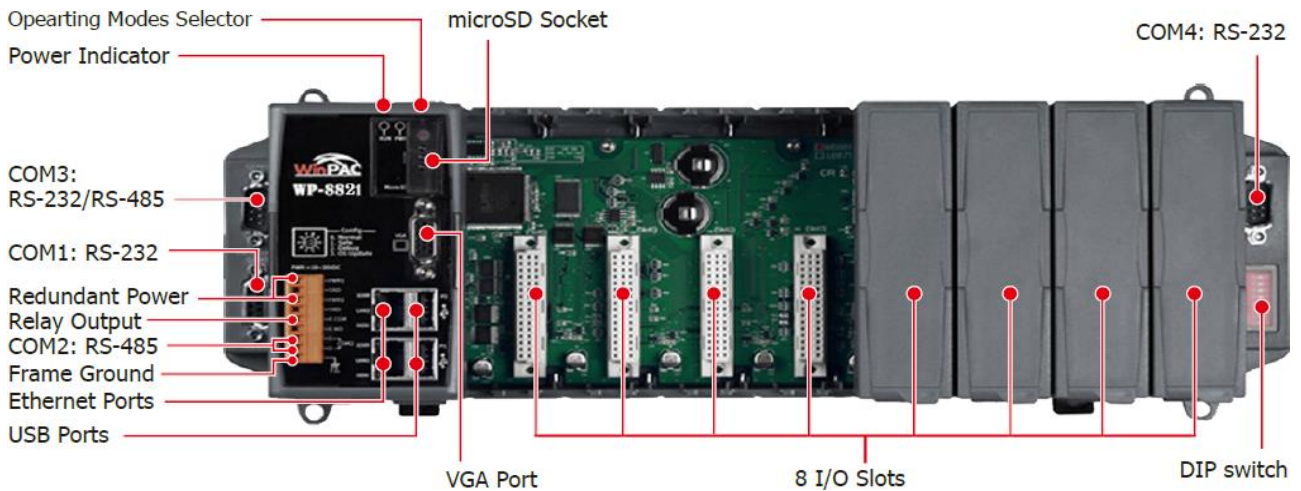

The details of these items are as follows:

LED Indicators

Each WP-8000-CE7 has 2 system LED indicators that display the status of the system and power, the meaning of these statuses are as follows as follows:

LED Indicator	Label	State (Color)	Meaning
PWR LED Indicator	PWR	Green	Power 1 is on
System/Programmable LED indicator	RUN	Orange	OS is running
		-	Programmable LED indicators

Operating mode Selector



Rotary Switch is an operating mode selector. The WP-8000-CE7 has several operating modes, for more detailed information about these operating mode, please refer to “2.4 Configuring the Boot Mode”

Redundant Power (PWR1 and PWR2) and relay output

The WP-8121-CE7/WP-8421-CE7/WP-8821-CE7 has a terminal with 12-wire/9-wire/9-wire; there are 4-wire for redundant power inputs and 2-wire for relay output, the details of the redundant power and relay output are shown to the side.

WP-8121-CE7

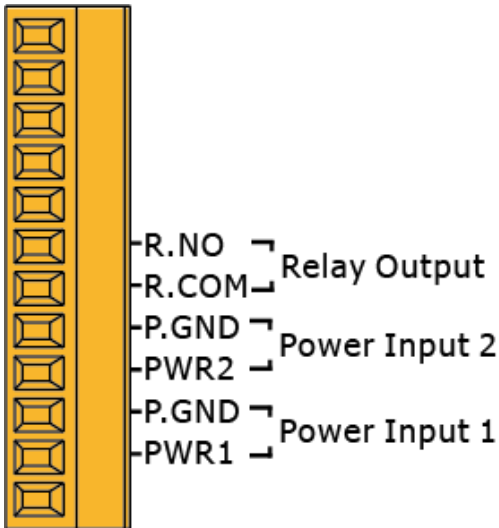

WP-8421-CE7 WP-8821-CE7

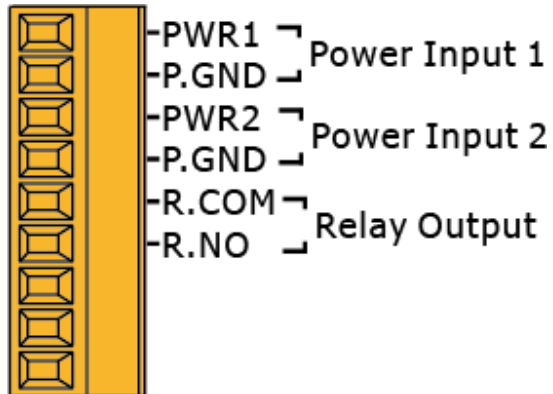

● Redundant Power

The WP-8000-CE7 provides redundant power that can keep the device running if a problem occurs in the power supply.

● Relay Output

The WP-8000-CE7 has a relay output that can be used to control a light, siren, or other low voltage device when an alarm occurs.

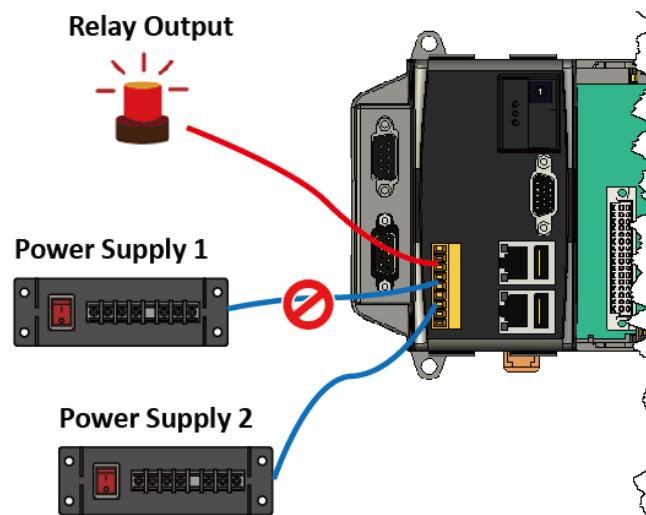

Communication Ports

The WP-8000-CE7 Series modules are equipped with several interfaces and peripherals that can be integrated with external systems.

- **VGA Port**

The VGA connector is a 3-row 15-pin connector that can be used to connect a monitor at a variety of supported VGA resolutions. and the output resolution covers, 800 x 600, 1024 x768.

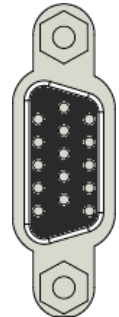

- **Ethernet Ports (LAN1 and LAN2)**

The WP-8000-CE7 has two Ethernet ports that can be used to connect the router to the Internet or to other devices.

Each Ethernet port has two LED indicators, which are used to indicate the network speed and Link/Acting, as described below.

LED Indicator	State (Color)	Meaning
1G	ON (Orange)	Network Speed: 1000 MB GB
	OFF	Network Speed: 10/100 MB
Link/Act	ON (Green)	The Link is active
	OFF	The Link is inactive
	Blinking(Green)	Network activity

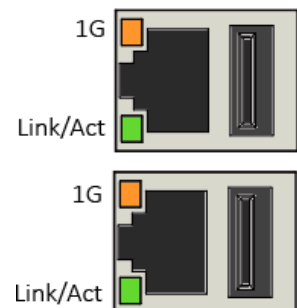

- **USB Ports (P1 and P2)**

The WP-8000-CE7 has two USB 2.0 ports that can be used to connect the USB devices such as mouse, keyboard or an external USB hard drive.

- **microSD Socket**

The microSD socket comes with a free microSD card that can be used to restore the system, and expand the memory up to 32 GB.

- **COM0, Expansion I/O Slot**

The WP-8000-CE7 has 1/4/8 I/O slots that can be used to integrate high performance parallel I/O modules (high profile I-8K Series) or serial I/O modules (high profile I-87K series).

- **COM1 (3-wire RS-232, for WP-8121-CE7 only)**

Note: 16C550 compatible

Port Type: Female

Baud Rate: 115200, 57600, 38400, 19200, 9600, 4800, 2400, 1200 bps

Data Bits: 7, 8

Parity: None, Even, Odd

Stop Bits: 1

FIFO: 64 byte

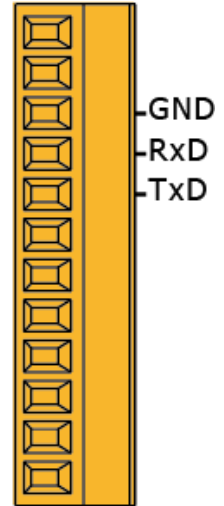

- **COM1 (RS-232, for WP-8421-CE7 and WP-8821-CE7 only)**

The COM1 port is a 9-pins RS-232 connector. The details of the COM1 port specifications are shown to the side.

Note: 16C550 compatible

Port Type: Female

Baud Rate: 115200, 57600, 38400, 19200, 9600, 4800, 2400, 1200 bps

Data Bits: 7, 8

Parity: None, Even, Odd

Stop Bits: 1

FIFO: 64 byte

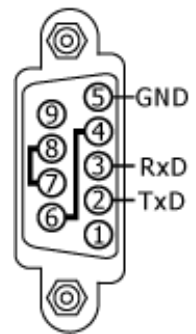

- **COM2 (2-wire RS-485)**

Note: 16C550 compatible

Port Type: Terminals

Baud Rate: 115200, 57600, 38400, 19200, 9600, 4800, 2400, 1200 bps

Data Bits: 5, 6, 7, 8

Parity: None, Even, Odd, Mark (Always 1), Space (Always 0)

Stop Bits: 1, 2

FIFO: 128 bytes

WP-8121-CE7

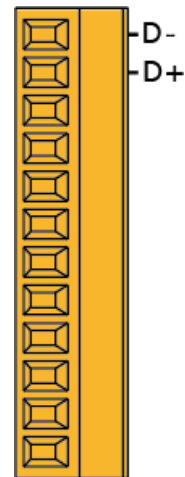

WP-8421-CE7
WP-8821-CE7

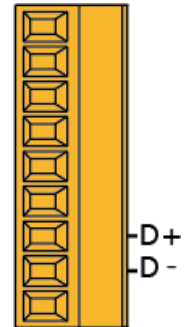

- **COM3 (RS-232/RS-485, for WP-8421-CE7 and WP-8821-CE7 only)**

The COM3 port is a 9-pins RS-232/RS-485 connector. The details of the COM3 port specifications are shown to the side.

Note: 16C550 compatible

Port Type: Male

Baud Rate: 115200, 57600, 38400, 19200, 9600, 4800, 2400, 1200 bps

Data Bits: 5, 6, 7, 8

Parity: None, Even, Odd, Mark (Always 1), Space (Always 0)

Stop Bits: 1, 2

FIFO: 128 bytes

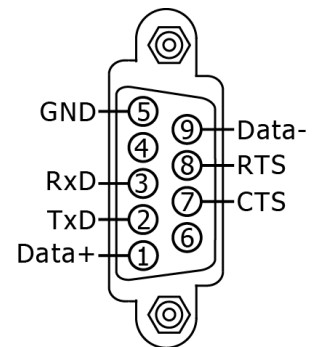

- **COM4 (RS-232, for WP-8421-CE7 and WP-8821-CE7 only)**

The COM4 port is a 9-pins RS-232 connector. The details of the COM4 port specifications are shown to the side.

Note: 16C550 compatible

Port Type: Male

Baud Rate: 115200, 57600, 38400, 19200, 9600, 4800, 2400, 1200 bps

Data Bits: 5, 6, 7, 8

Parity: None, Even, Odd, Mark (Always 1), Space (Always 0)

Stop Bits: 1, 2

FIFO: 128 bytes

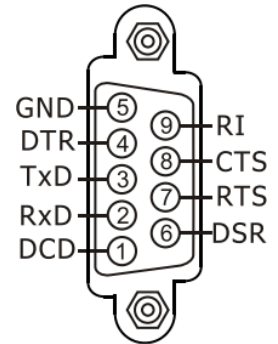

Tips & Warnings



The table below shows the data bit and their corresponding stop bit for COM1, COM2, COM3 and COM4.

Word Length	Number of Stop Bits
5, 6, 7, 8	1
5	1.5
6, 7, 8	2

- **DIP Switch**

The DIP switch can be used to set the Module ID to a number from 0 to 255. Do not use Module ID 0 for communication.

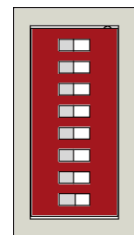

1.4. Dimensions

The diagrams below provide the dimensions of the WP-8000-CE7 to use in defining your enclosure specifications. Remember to leave room for potential expansion if you are using other components in your system.

The height dimension is the same for all WP-8000-CE7. The width depending on your choose of I/O expansion slots. All dimensions are in millimeters.

WP-8121-CE7

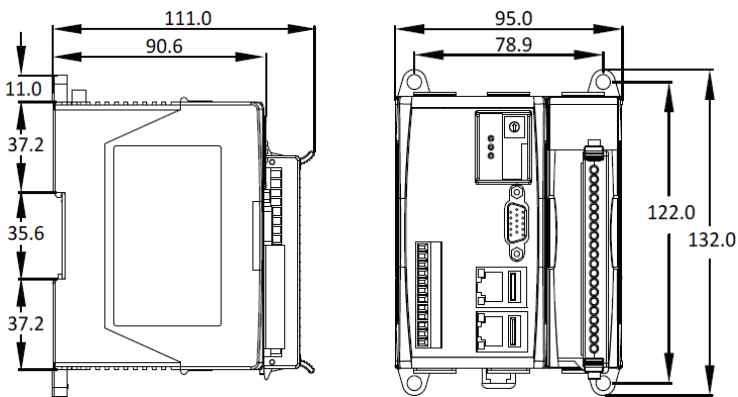

WP-8421-CE7

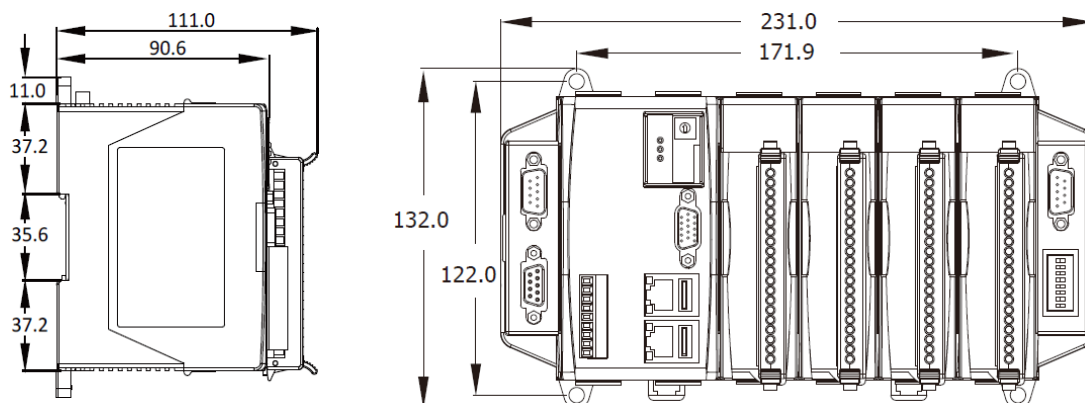

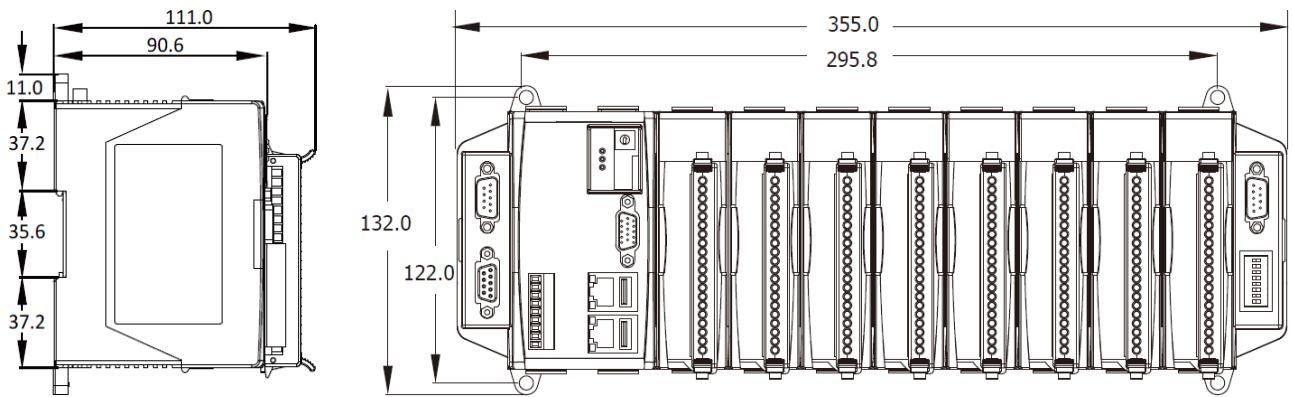

1.5. Companion CD

This package comes with a CD that provides a collection of the software utility, documentation, drivers, demo program and application. The CD contains several subdirectories located in \wp-8x2x directory. All of them are listed below.

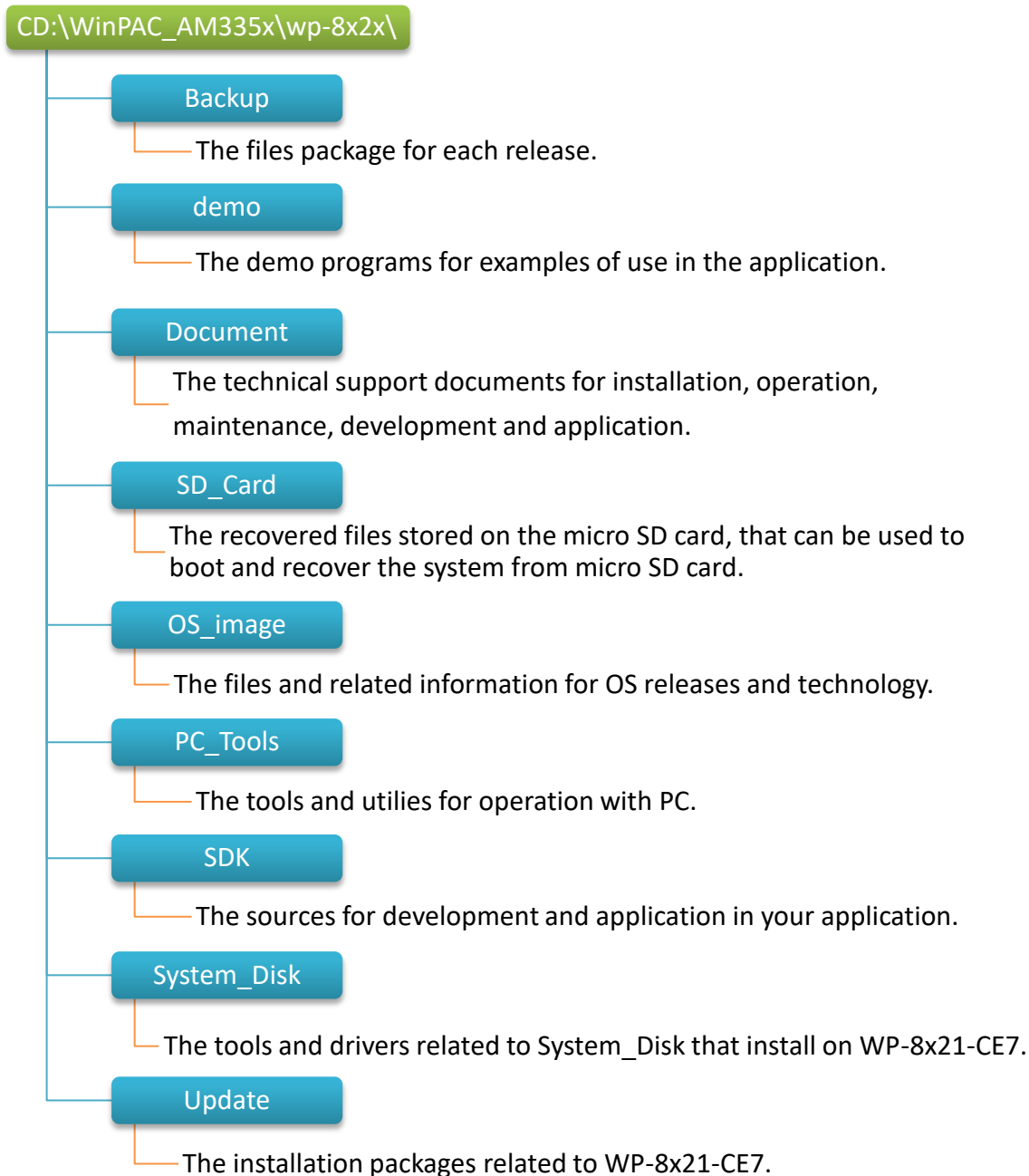

2. Getting Started

This chapter provides a guided tour of the WP-8000-CE7 installation and configuration that describes the steps needed to download, install, configure, and run the basic procedures for user working with the WP-8000-CE7 for the first time.

Before starting any task, please check the package contents. If any of the following package contents are missing or damaged, contact your dealer, distributor.



WP-8121-CE7/WP-8421-CE7/WP-8821-CE7



A microSD card and a micro SD/SD adapter

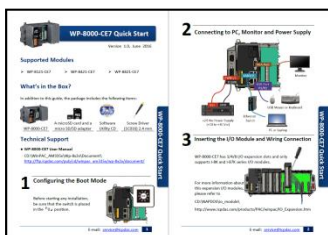

Quick Start Guide



Software Utility CD



Screw Driver (1C016) 2.4 mm

2.1. Mounting the WP-8000-CE7

The WP-8000-CE7 can be mounted either directly to a wall/panel, or onto a standard 35mm DIN rail.

Wall/Panel mounting

Step 1: Install the four mounting screws into the 4 keyhole mounting holes

Step 2: Fasten the screws securely

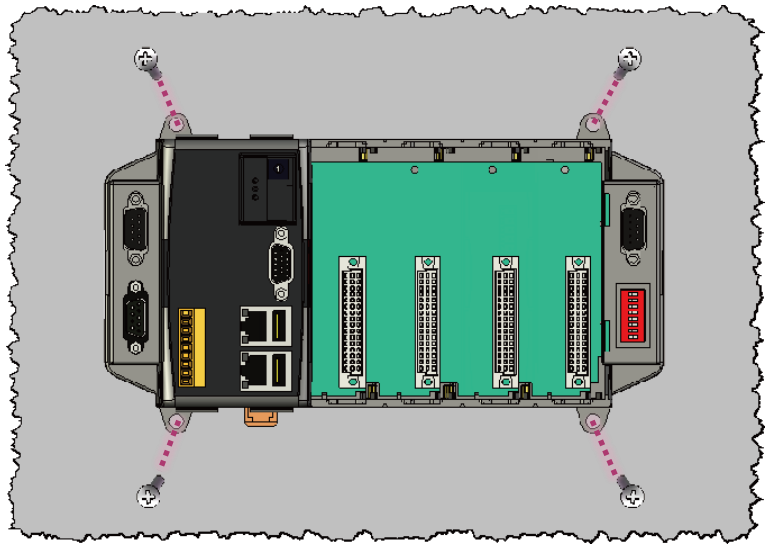

Tips & Warnings



There must be a minimum clearance of 50mm between the WP-8000-CE7 and the top and bottom side of the enclosure panel.

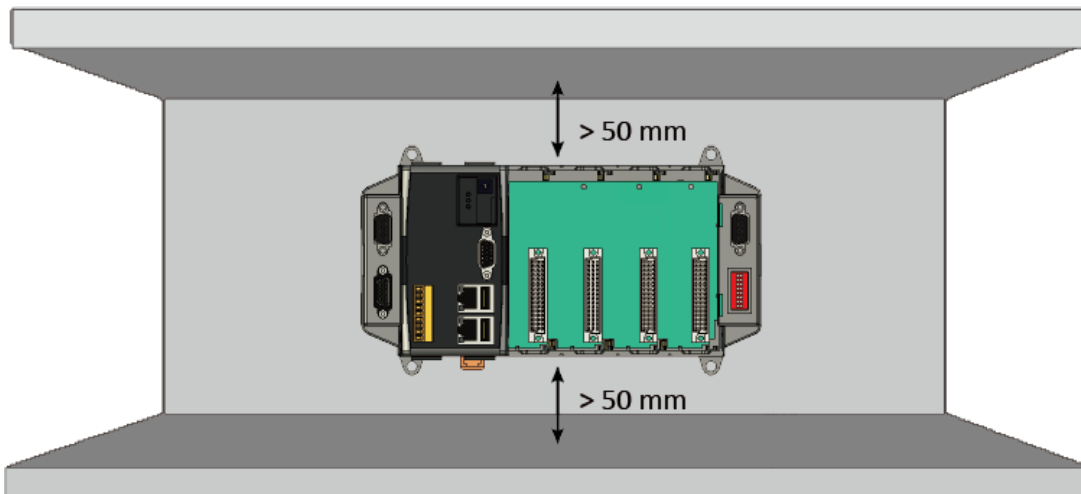

Step 1: Hook upper tab over upper flange of DIN rail

Step 2: Tilt the module toward DIN rail until it snaps securely to DIN rail

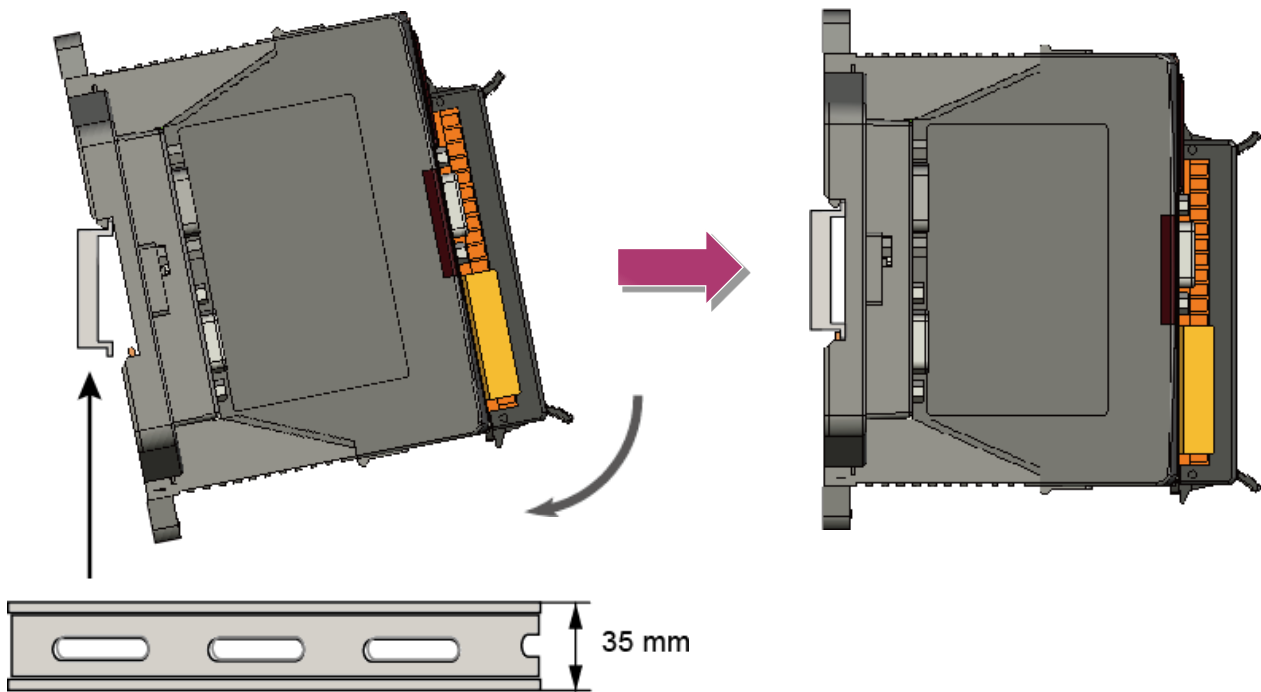

Step 3: Push up retaining clips

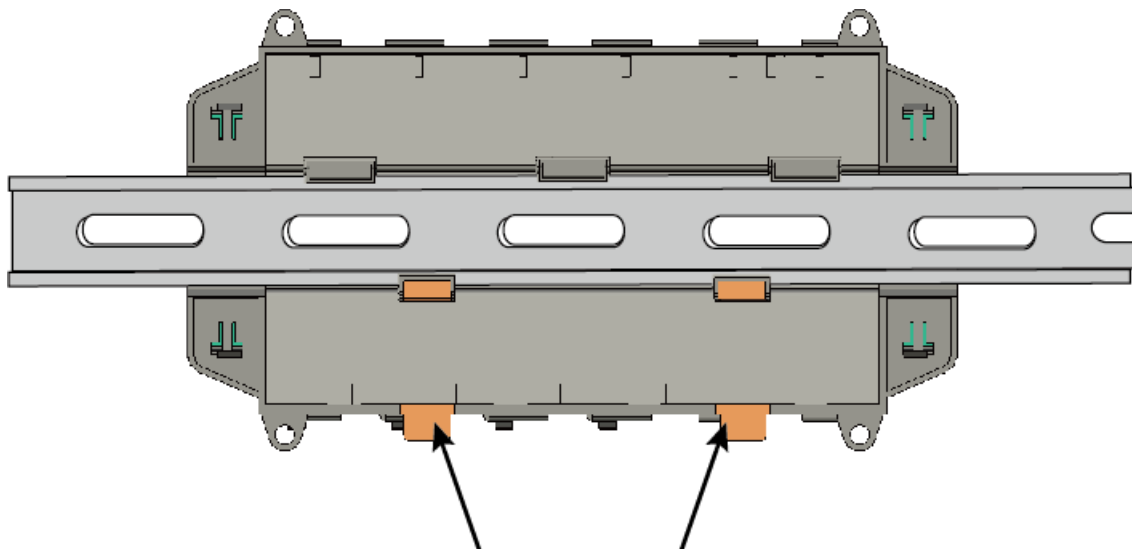

Gently push up retaining clips

Tips & Warnings



A good common ground reference (earth ground) is essential for proper operation of the WP-8000-CE7. One side of all control circuits, power circuits and the ground lead must be properly connected to earth ground by either installing a ground rod in close proximity to the enclosure or by connecting to the incoming power system ground. There must be a single-point ground (i.e. copper bus bar) for all devices in the enclosure that require an earth ground.

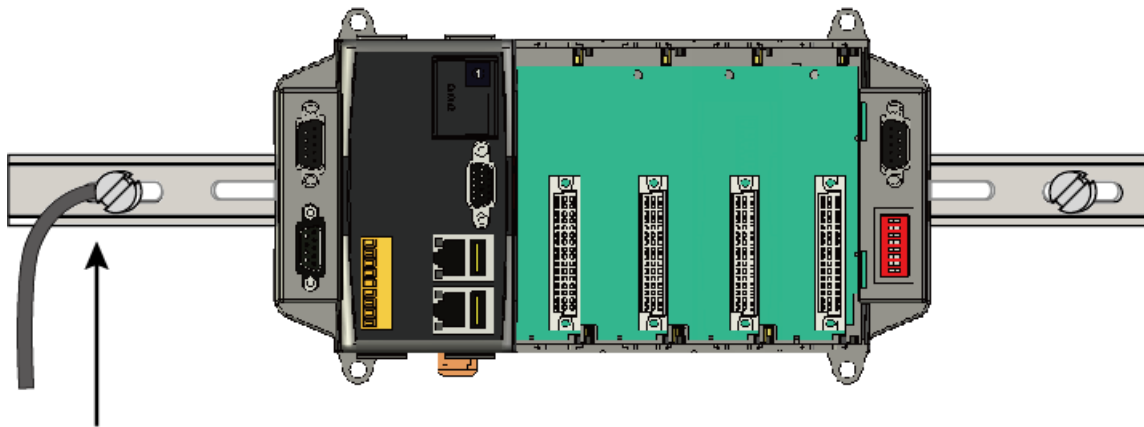

Connect the ground lead to the ground screw

2.2. Deploying a Basic WP-8000-CE7 System

The WP-8000-CE7 provides a variety of communication interface to suit a range of application. Here is a simple application for using the WP-8000-CE7.

Step 1: Connect the positive terminal (+) of the power supply to the terminal PWR1/2 and the negative terminal (-) of the power supply to the P.GND

Tips & Warnings



1. The input range of power supply is +10 to +30 V_{DC}.
2. The WP-8000-CE7 have two power inputs that can be connected simultaneously to the two independent power sources. If one power source fails, the other source takes over automatically. Redundant power inputs help assure non-stop operation of the WP-8000-CE7.

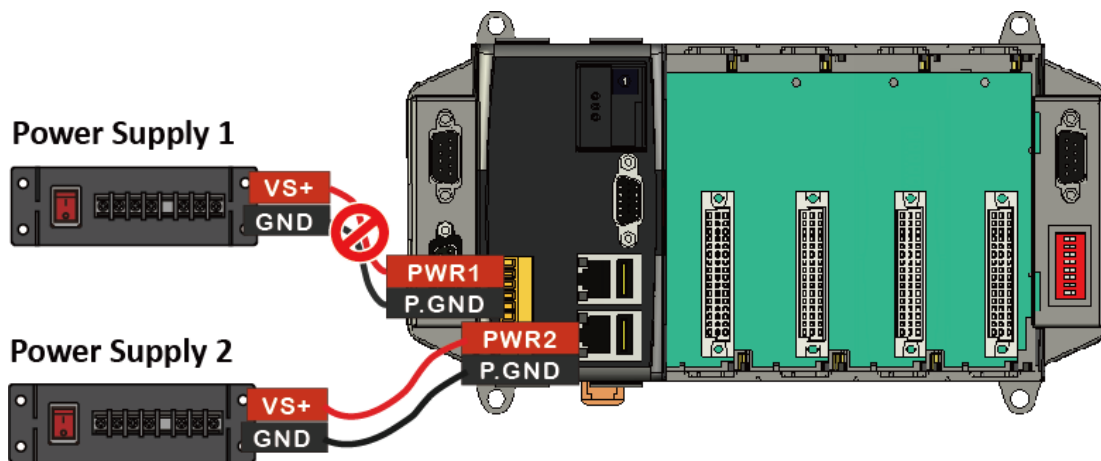

Step 2: Connect the USB mouse or the USB keyboard to the USB port

Step 3: Connect the monitor to the VGA port

Step 4: Connect to PC or the laptop to the LAN port via an Ethernet switch

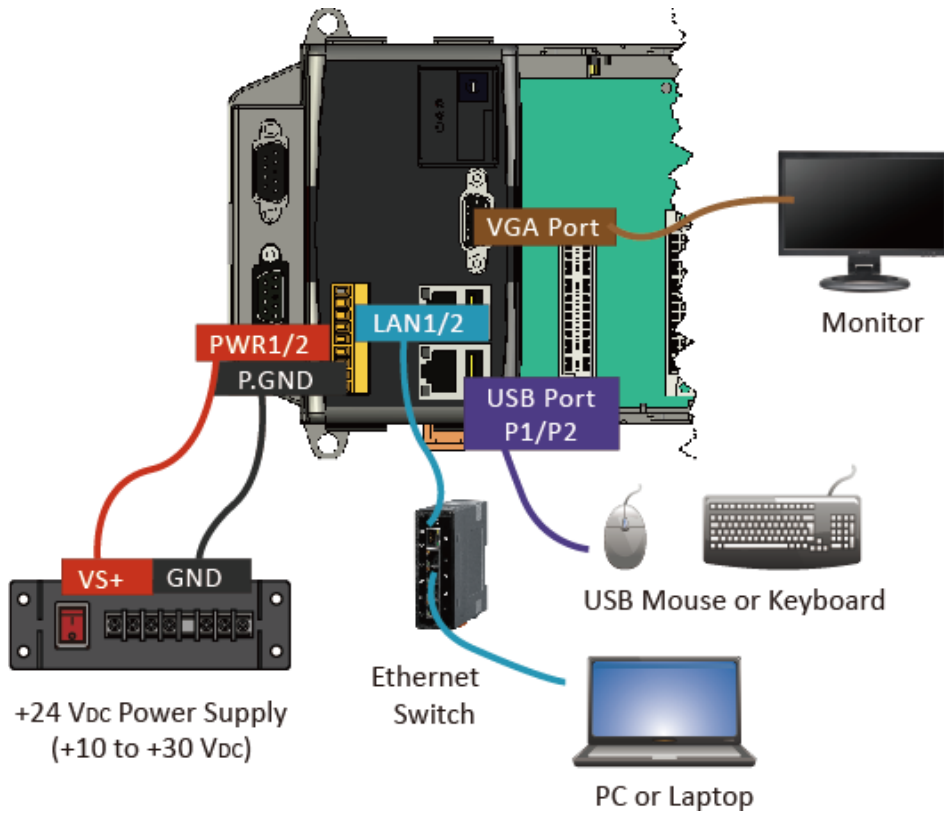

2.3. Installing the I/O Modules

WP-8000-CE7 has 1/4/8 I/O expansion slots and only supports I-8K and I-87K series I/O modules.

Before choosing the right I/O modules, you first need to know the I/O expansion capacities in order to choose the best expansion module for achieving maximal efficiency. For more information about the I/O expansion modules that are compatible with the WP-8000-CE7, please refer to: [http://www.icpdas.com/en/product/guide+Remote I O Module and Unit+Software Support +I-8K I-87K Software Support](http://www.icpdas.com/en/product/guide+Remote+I+O+Module+and+Unit+Software+Support+I-8K+I-87K+Software+Support)

Step 1: Align circuit card with slot and press firmly to seat module into connector

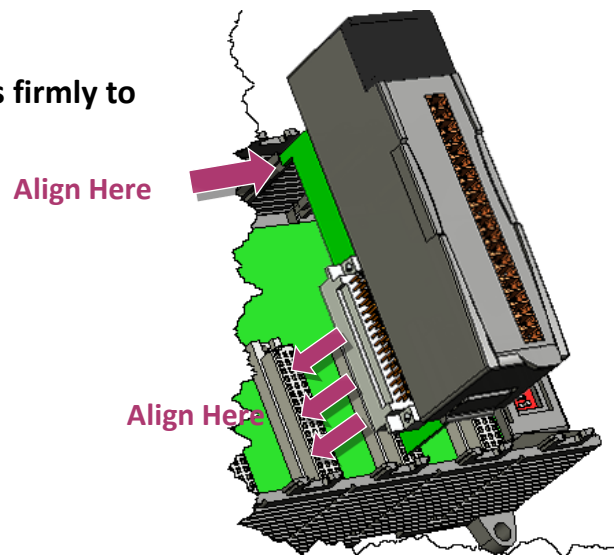

Tips & Warnings



It is recommended that the power to the WP-8000-CE7 is switched off when wiring the I/O module which are plugging in the WP-8000-CE7 slots.

Step 2: Pull top and bottom locking tabs toward module face. Click indicates lock is engaged

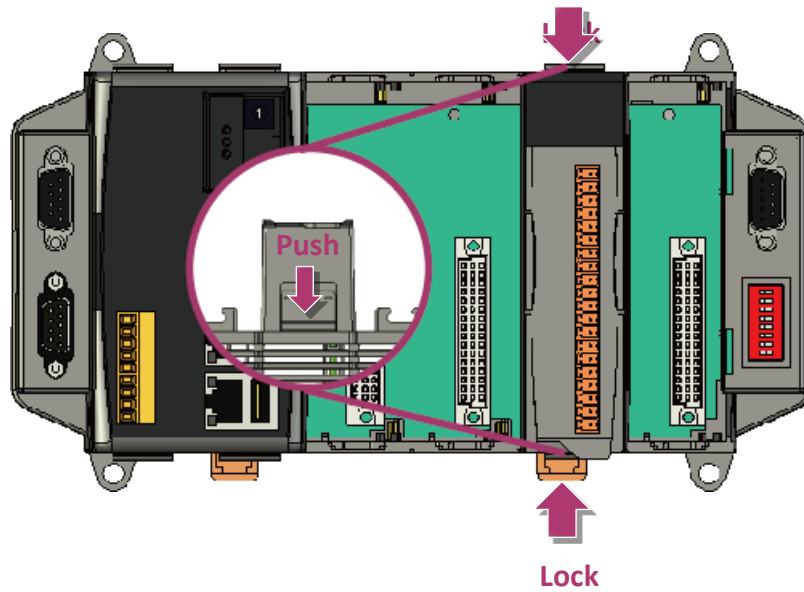

Step 3: Attach field wiring using the terminal block, and then insert the terminal block

All I/O Web Page include the I/O module specifications, pin assignments and wiring connections.

For example, Pin Assignments and Wiring connections for the I-87054W module are as follows:

<http://www.icpdas.com/en/product/I-87054-G>

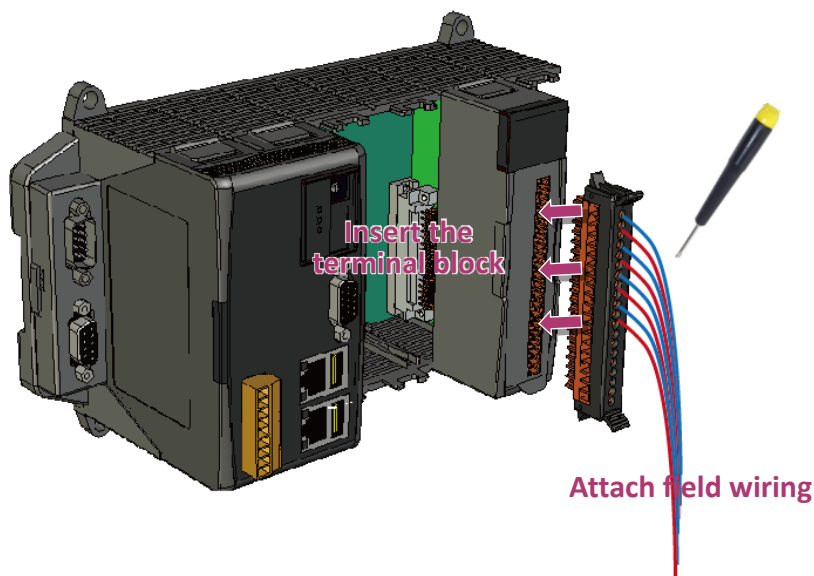

2.4. Configuring the Boot Mode

The WP-8000-CE7 has several operating modes, which can be selected by a rotary switch.

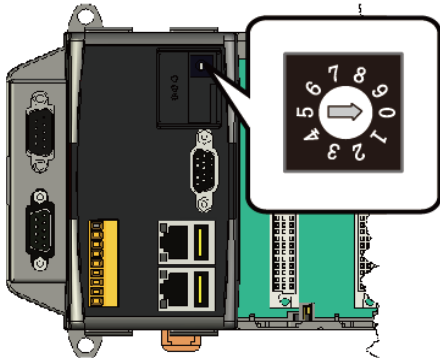

The table below lists the operation modes available with the WP-8000-CE7.

Position	Operating Mode
0	Normal mode (Default)
1	Safe mode
2	Debug mode
3	OS update mode by Ethernet
4	Reserve
5	OS update mode by microSD
6	Reserve (OS Development Mode)
7 ~ 9	User Mode

The following is a brief introduction of these modes.

Normal Mode (Default mode)

Normal mode is the default mode of operation and the one you will use most of the time. Use this mode for more tasks and configurations. Programs also are executed in this mode.

Safe Mode

Safe mode is a troubleshooting mode. The mode loads the minimum required device drivers and system services to boot the WP-8000-CE7.

If you have malicious software or a program caused the WP-8000-CE7 cannot be boot or run the normal mode, you can boot in safe mode to solve the problem.

Debug Mode

Debug mode is a special environment in which program debug functions can be used in addition to normal system functions.

Debug mode is unsupported.

OS Update Mode

OS update mode is a way used to update OS. For more information on updating the WP-8000-CE7 OS image, please refer to section 7.1. OS updates

Reserve → OS Development Mode

The positions 4, 6, of rotary switch are reserved for OS development.

User Mode

The positions 7, 8, 9 of rotary switch are reserved for user's applications.

When WP-8000-CE7 is boot with one of these positions, it is boot at normal mode.

User's application can check the position of the rotary switch position to run at different mode.

2.5. Changing the User Interface Language

The **Regional and Language Settings** is a Windows CE functionality that allows users to change the WP-8000-CE7 user interface with your native language.

Step 1: Click Start menu, point to Settings, click Control Panel, and then click Regional Settings

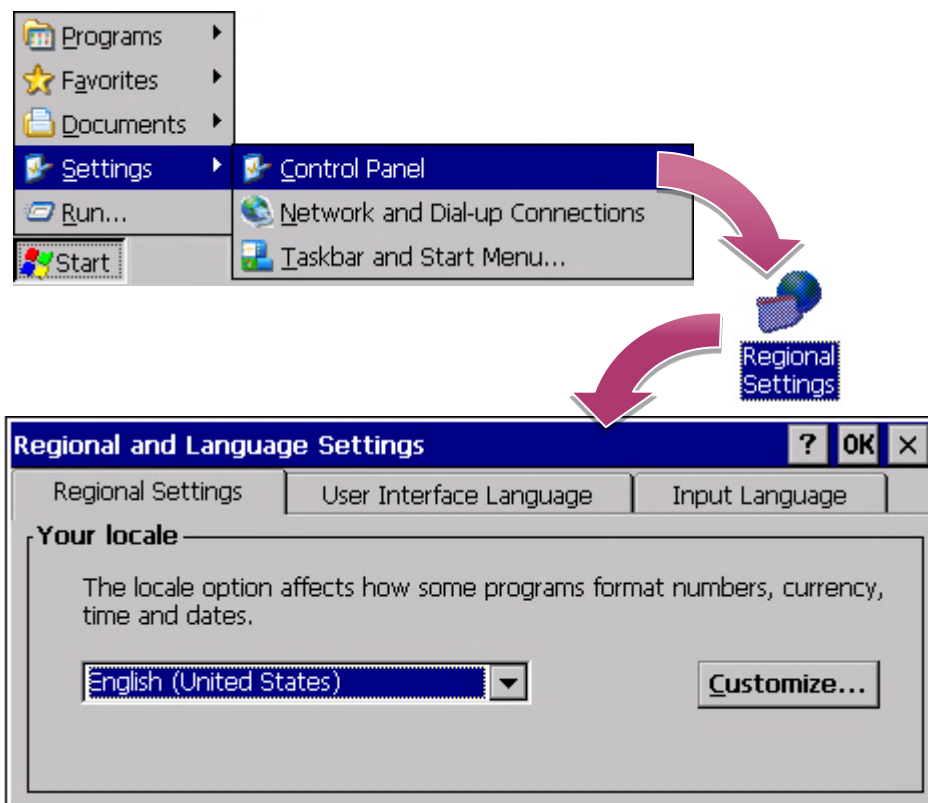

Step 2: Click User Interface Language tab, choose to your local language, and then click OK button



Step 3: Double-click the PAC Utility on the desktop, and then reboot the WP-8000-CE7 for changes to take effect

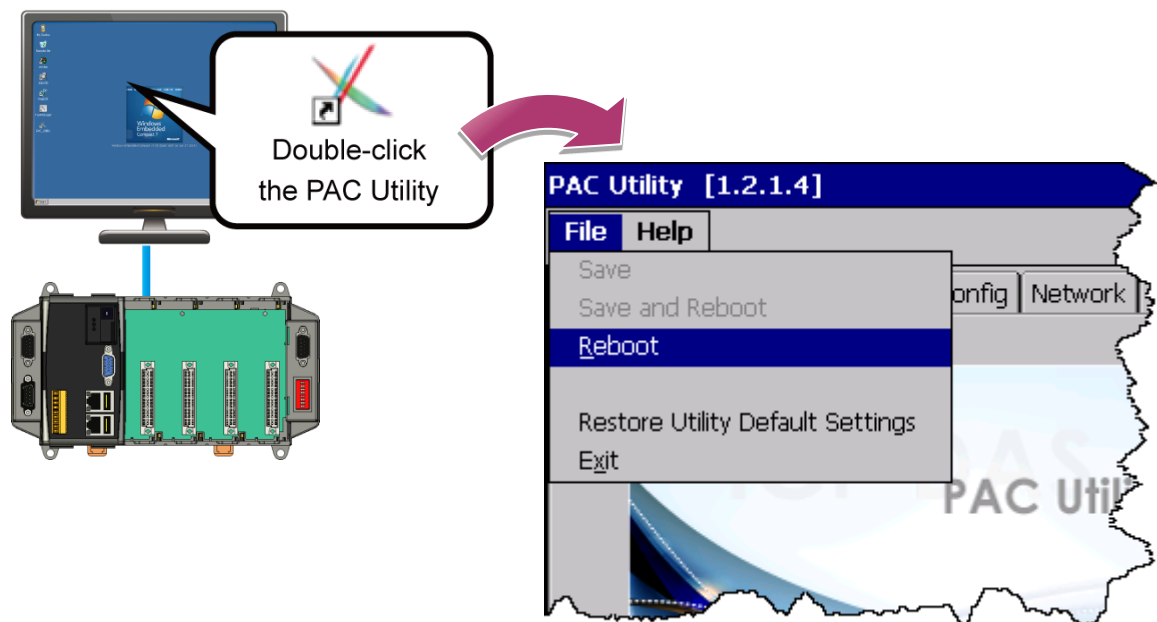

2.6. Using PAC Utility to Manage the WP-8000-CE7

The PAC Utility is a collection of the WP-8000-CE7 system tool that allows users to manage and configure the WP-8000-CE7 quickly and easily.

For more detailed information on PAC Utility applications, please refer to “3.1. PAC Utility”

Step 1: Double-click the PAC Utility on the desktop

Step 2: Configure IP address (DHCP), FTP Server, Auto Execution files..., etc.

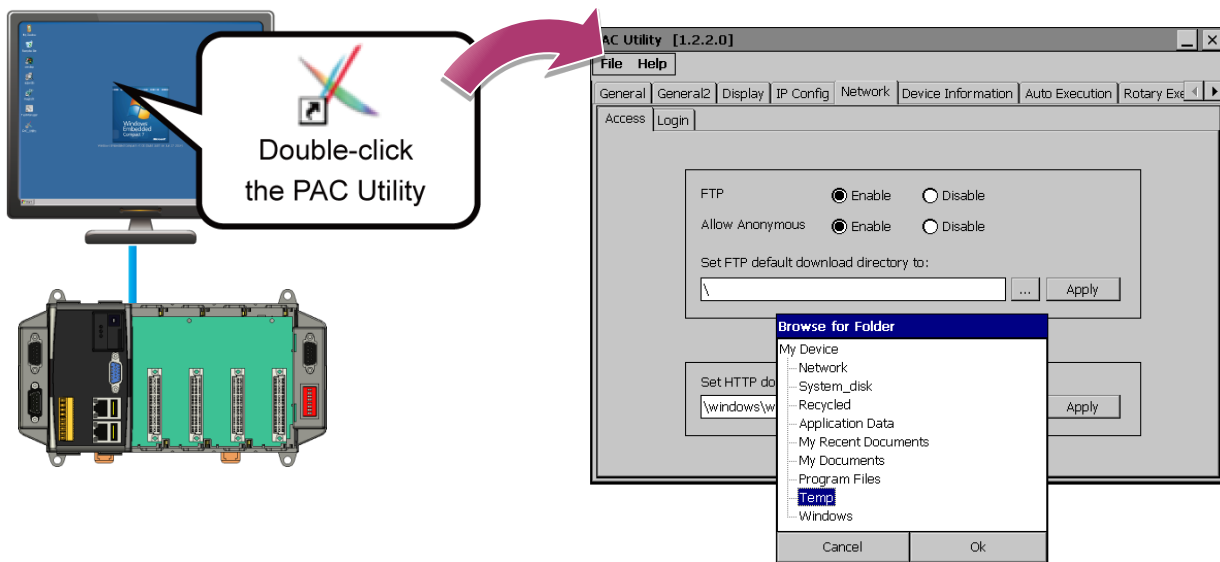

Step 3: Reboot the WP-8000-CE7 for changes to take effect

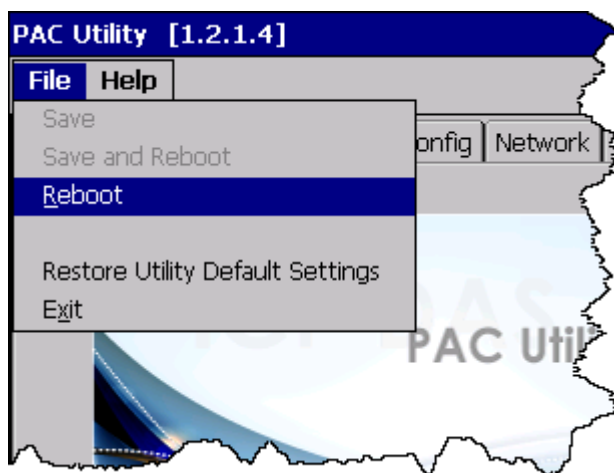

2.7. Using DCON Utility Pro Configure I/O Modules

DCON Utility Pro allows users to configure and manage the I/O modules via Ethernet or serial ports (RS-232/RS-485).

Step 1: Double-click the DCON_Utility_Pro on the desktop

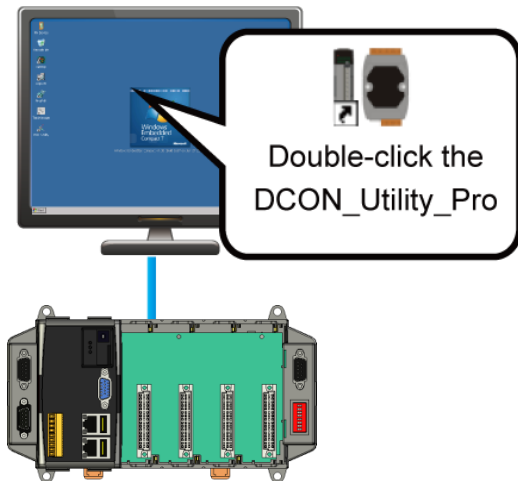

Step 2: Click the



button

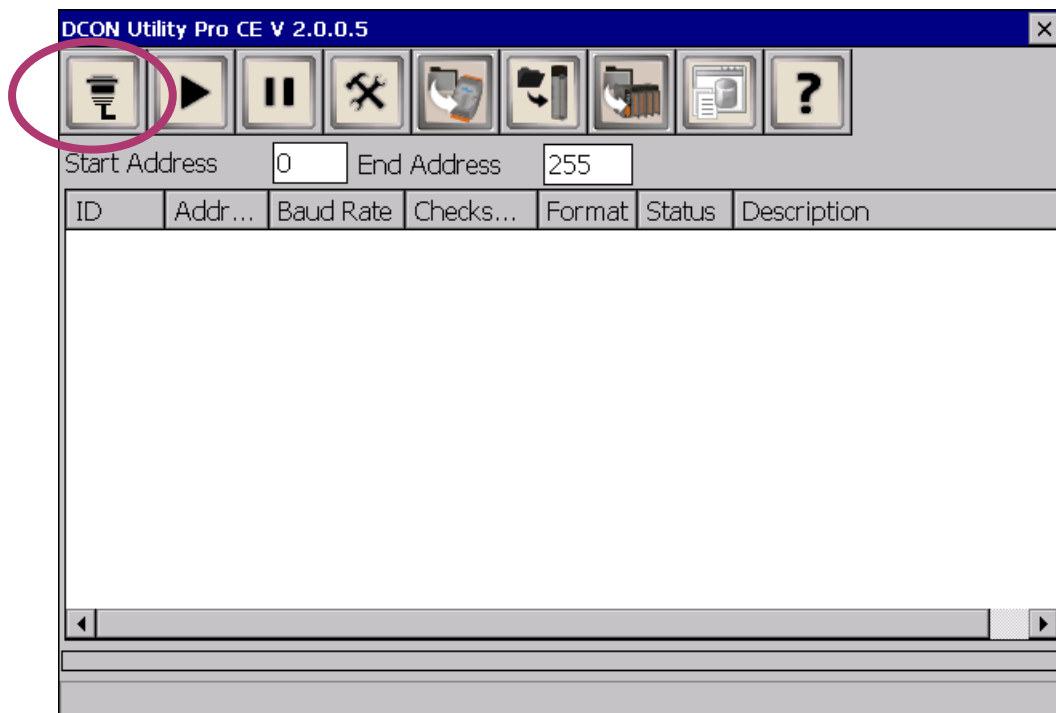

Step 3: Configure the communication settings

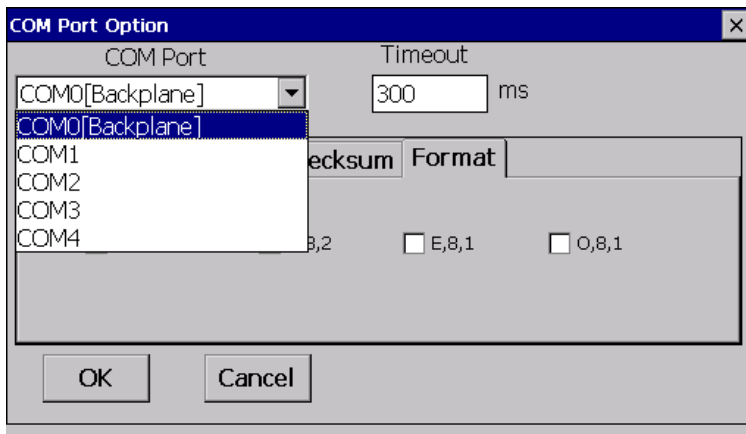

Tips & Warnings



The COM port settings for expansion I/O modules are listed below.

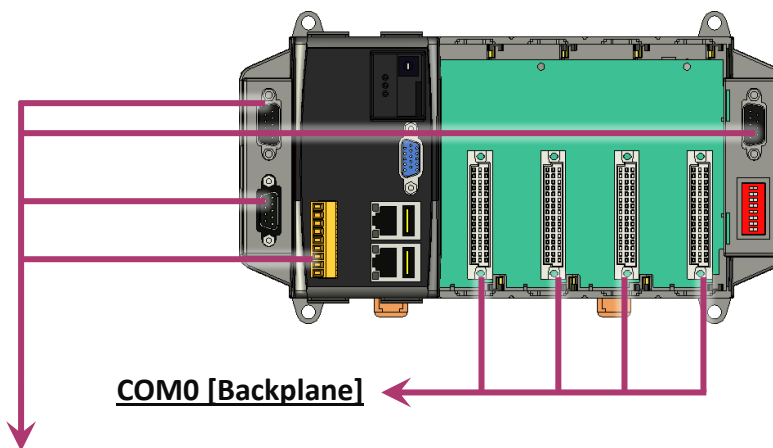

COM1/2/3/4

For more information on these COM port selections, please refer to the specification of the pin assignments in section 1.3. Overview

Step 4: Click the  button to scan the I/O module

Step 5: Click the module name to configure the I/O module

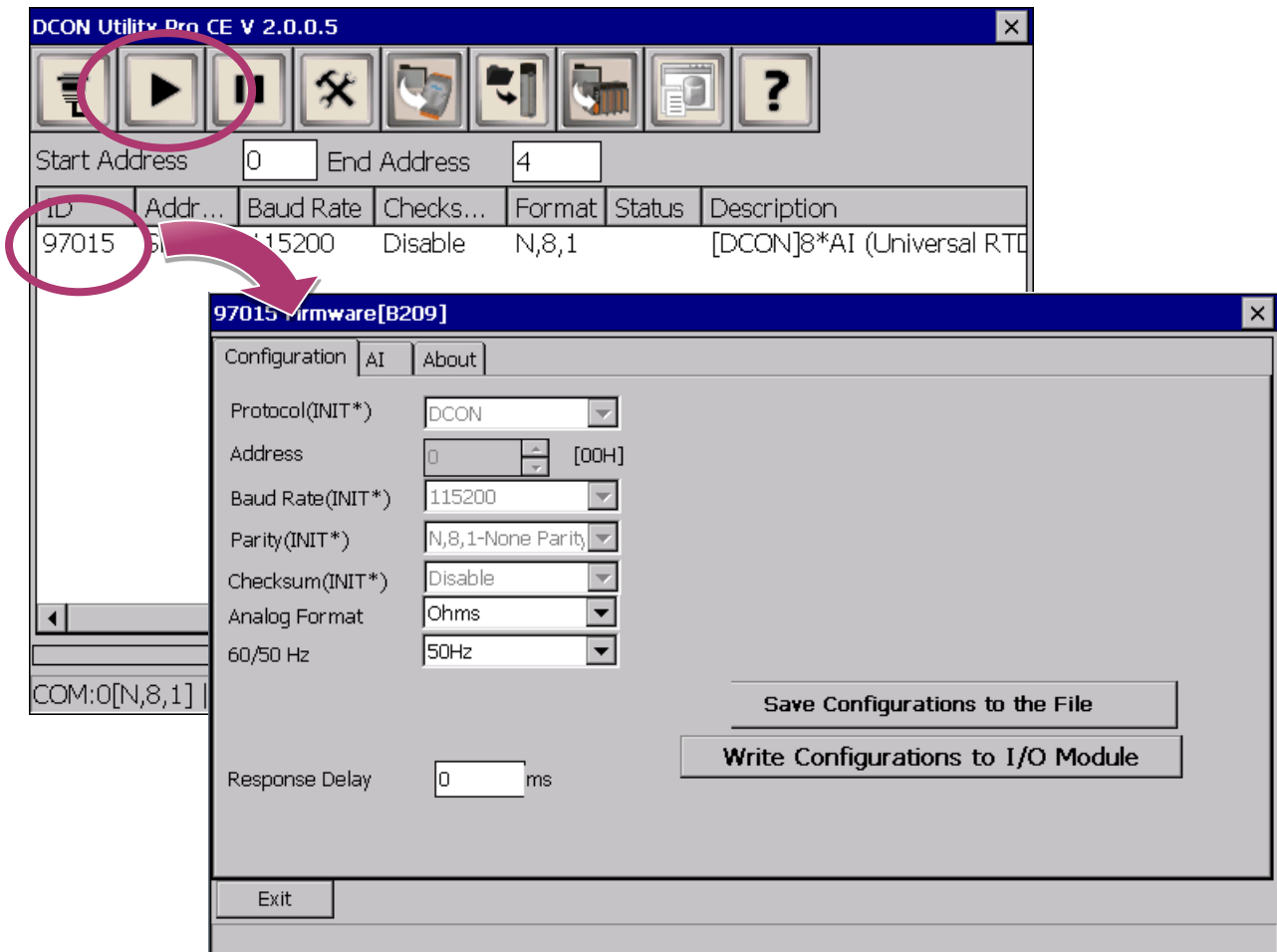

3. Tools and Tasks

This chapter provides a brief introduction of the WP-8000-CE7 service tools and its benefits.

There are several tools and utilities built-in and designed for use with WP-8000-CE7. Some of these are pre-installed on WP-8000-CE7 and can work directly on WP-8000-CE7, and some of these are supporting tools and can help you to manage the WP-8000-CE7 remotely on a PC.

The following tools are pre-installed on WP-8000-CE7 and can work directly on WP-8000-CE7 that can be found on the CD that was provided with the package or by downloading the latest version from ICP DAS web site.

CD:\WinPAC_AM335x\wp-8x2x\System_Disk\Tools\

http://ftp.icpdas.com/pub/cd/winpac_am335x/wp-8x2x/system_disk/tools/

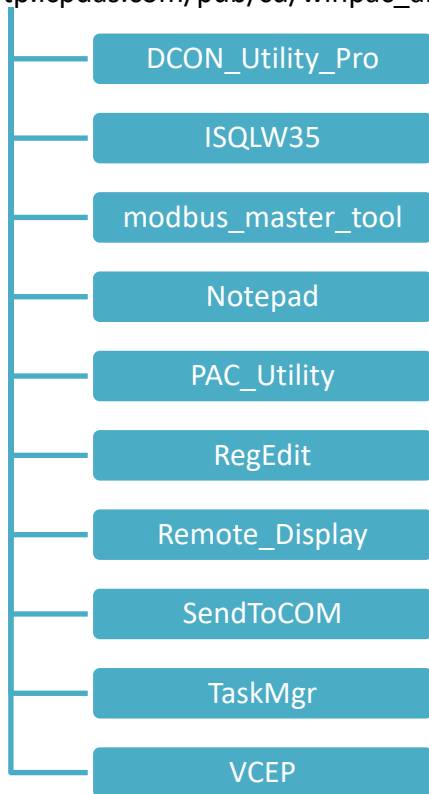

3.1. PAC Utility

PAC Utility is a collection of software applications that enable management and configuration of WP-8000-CE7 system and features.

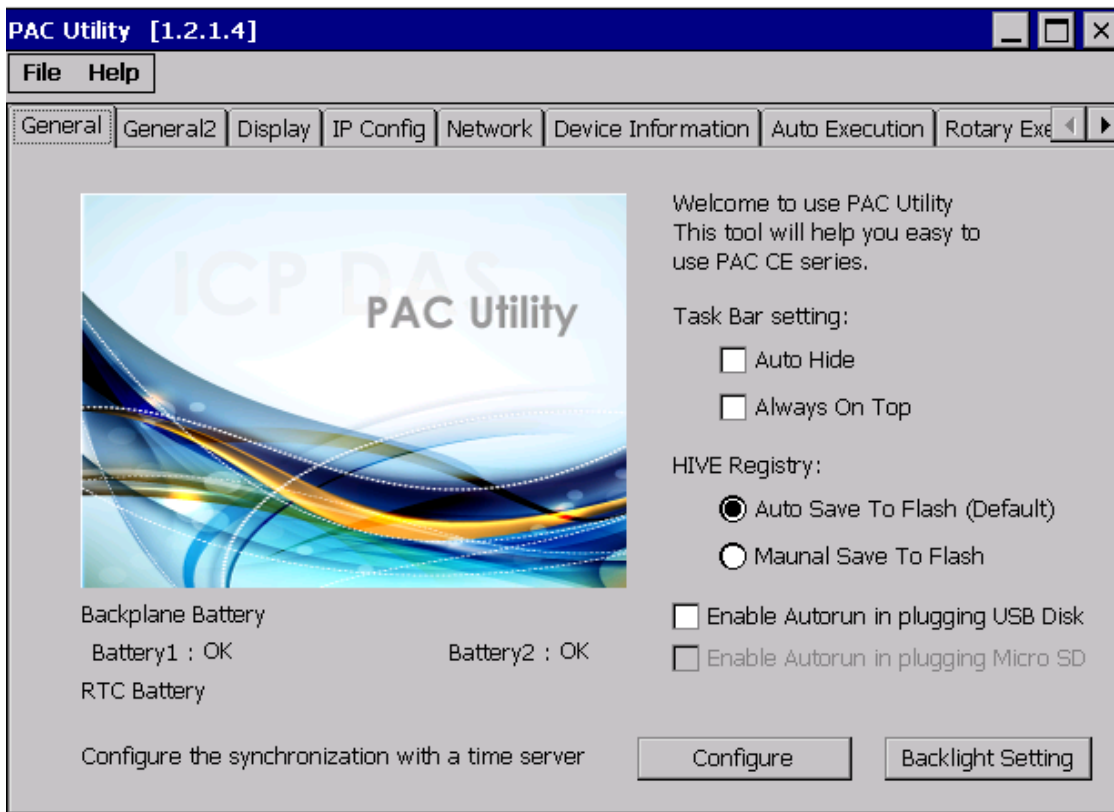

The PAC Utility includes the following menu bars and property tabs. All of these functions will be explained later.

Menu bar	Property Tab
File	General
Help	General2
	Display
	IP Config
	Network
	Device Information
	Auto Execution
	Rotary Execution

3.1.1. Menu Bar – File

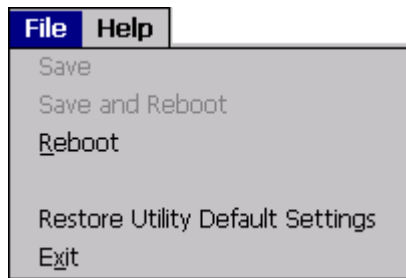

The menus use to	How to use
Reboot	Restarts the WP-8000-CE7
Restore Utility Default Settings	Restore the WP-8000-CE7 to default settings.
Exit	Exits the PAC Utility.

3.1.2. Menu Bar – Help

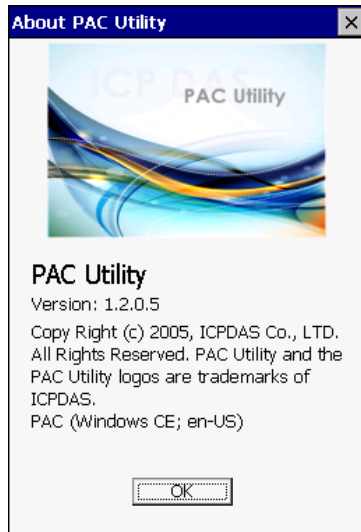

The menus use to	How to use
About	Displays a dialog box with information about PAC Utility, including the current version and copyright information.

3.1.3. Property Tab - General

The **General** tab provides functions to configure the task bar, check the status of the battery..., etc.

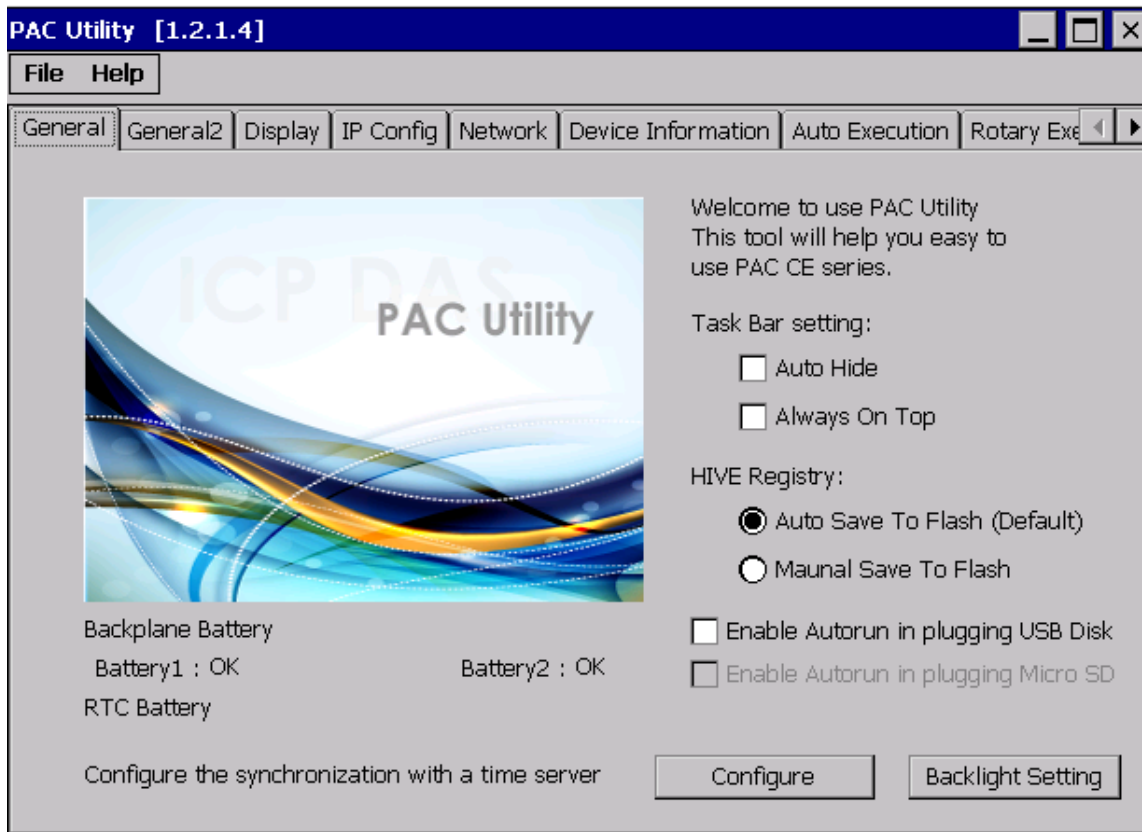

The tab use to	How to use
Lock or Auto-Hide the taskbar	<p>Auto-Hide the taskbar: Select the Auto Hide check box.</p> <p>Lock the taskbar: Select the Always On Top check box.</p>
Auto save or manual save to flash	<p>Auto save to flash: Select the Auto Save To Flash (Default) check box. Any changes made to the WP-8000-CE7 will be saved and only take effect after the WP-8000-CE7 reboots.</p> <p>Manual save to flash: Select the Manual Save to Flash check box. Any changes made to the WP-8000-CE7 will be saved by clicking the Save and Reboot from File menu.</p>

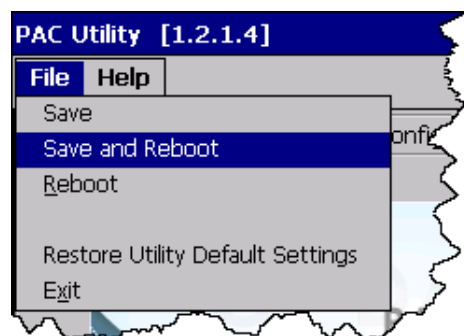

The tab use to	How to use
Enable USB autorun	Select the Enable Autorun in plugging USB Disk check box.
Enable microSD auotrun	This item is temporarily unavailable.
Automatic synchronization of system time	Refer to the Appendix A.2. How to configure the service for automatically synchronizing with the internet time server.

3.1.4. Property Tab – General2

The **General2** tab provides functions to specify the name of the USB disk.



The tab use to	How to use
Specify the name of the USB disk	Enter a name in the USB Hard Disk: field

3.1.5. Property Tab – Display

The **Display** tab provides functions to configure the monitor settings.

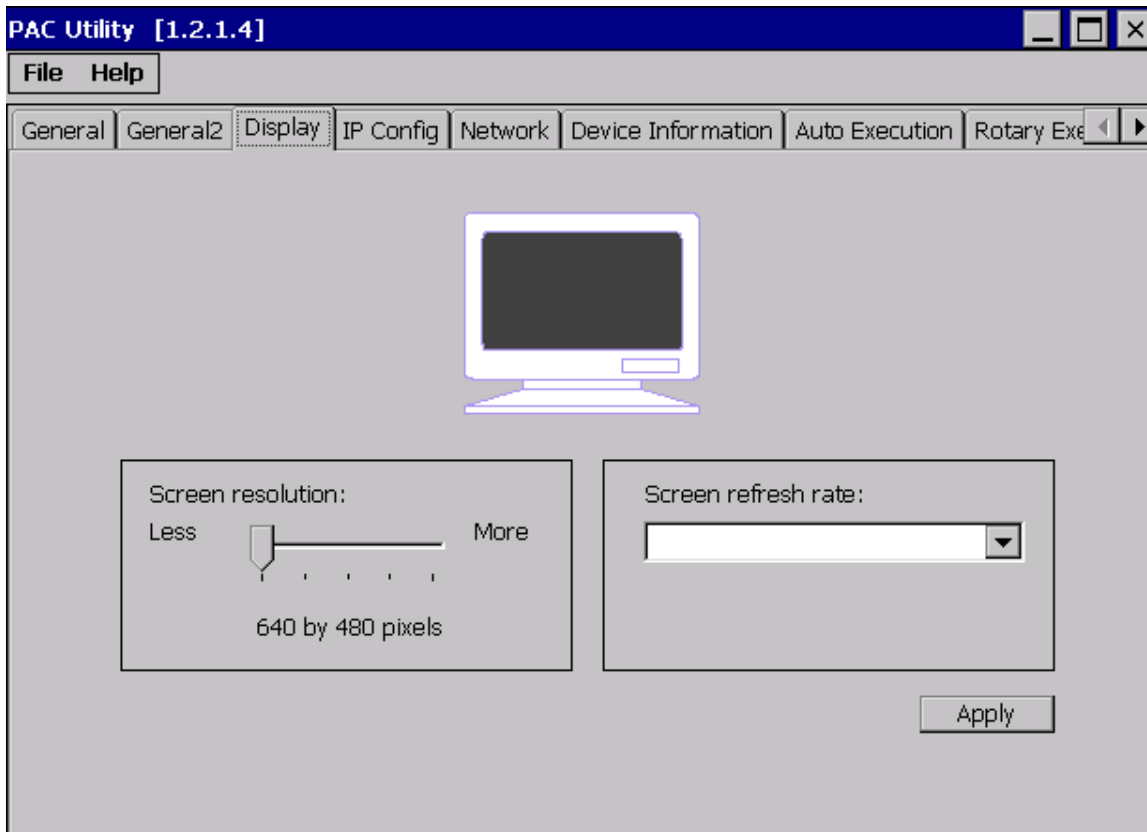

The tab use to	How to use
Adjust the screen resolution	Move the slider to the left to decrease the resolution or move the slider to the right to increase the resolution, and then click the Apply button.
Change the screen refresh rate	Select the desired refresh rate from the Screen refresh rate drop-down list, and then click the Apply button.

3.1.6. Property Tab – IP Config

The **IP Config** tab provides functions to configure either DHCP (Roaming) or manually configured (Static) network settings and to monitor the MAC address. Generally, DHCP is the default settings, but if you don't have a DHCP server, you must configure the network settings by using manual configuration.

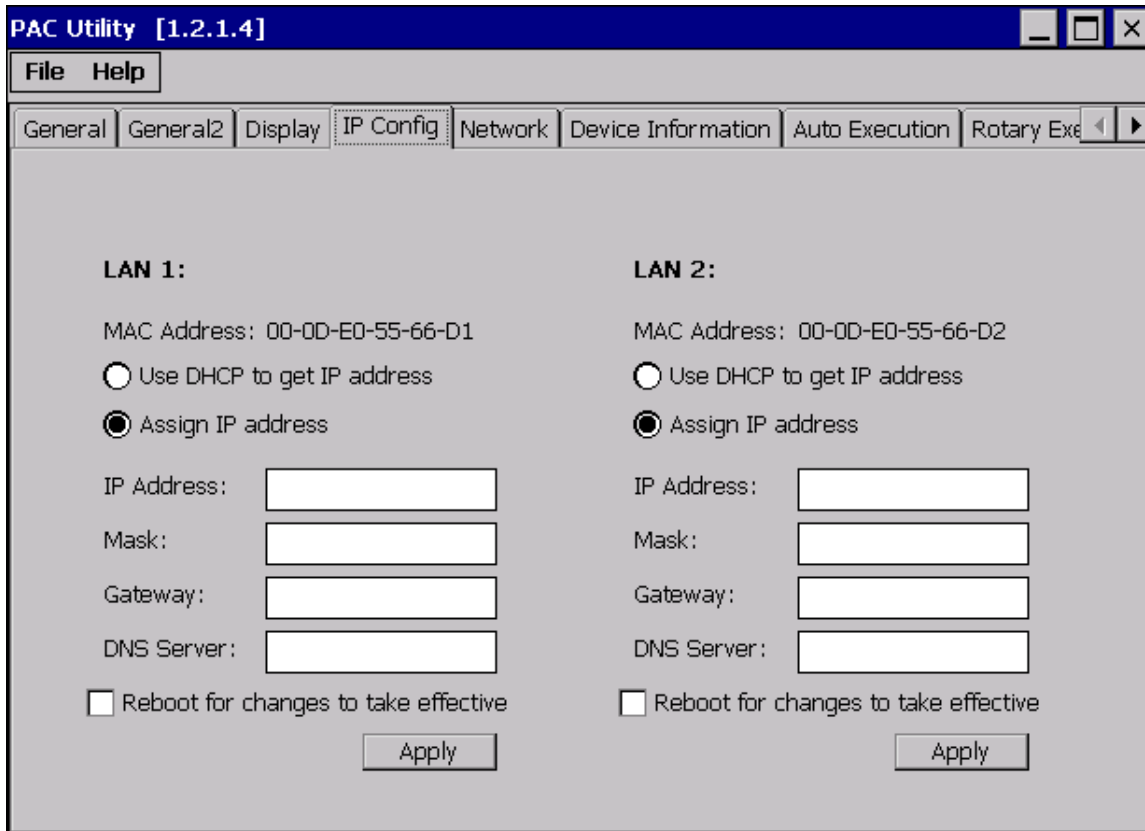

The tab use to	How to use
Set the network settings	<p>Use DHCP to get IP address: Select the Use DHCP to get IP address option, and then click the Apply button.</p> <p>Assign an IP address: Select the Assign IP address option, and then click the Apply button.</p>

3.1.7. Property Tab – Network

The **Network** tab comprises three tabs – Access, Login and File Server Settings.

Access

The **Access** tab provides functions to enable/disable the FTP access, enable/disable anonymous FTP access, and configure the FTP and HTTP directory path.

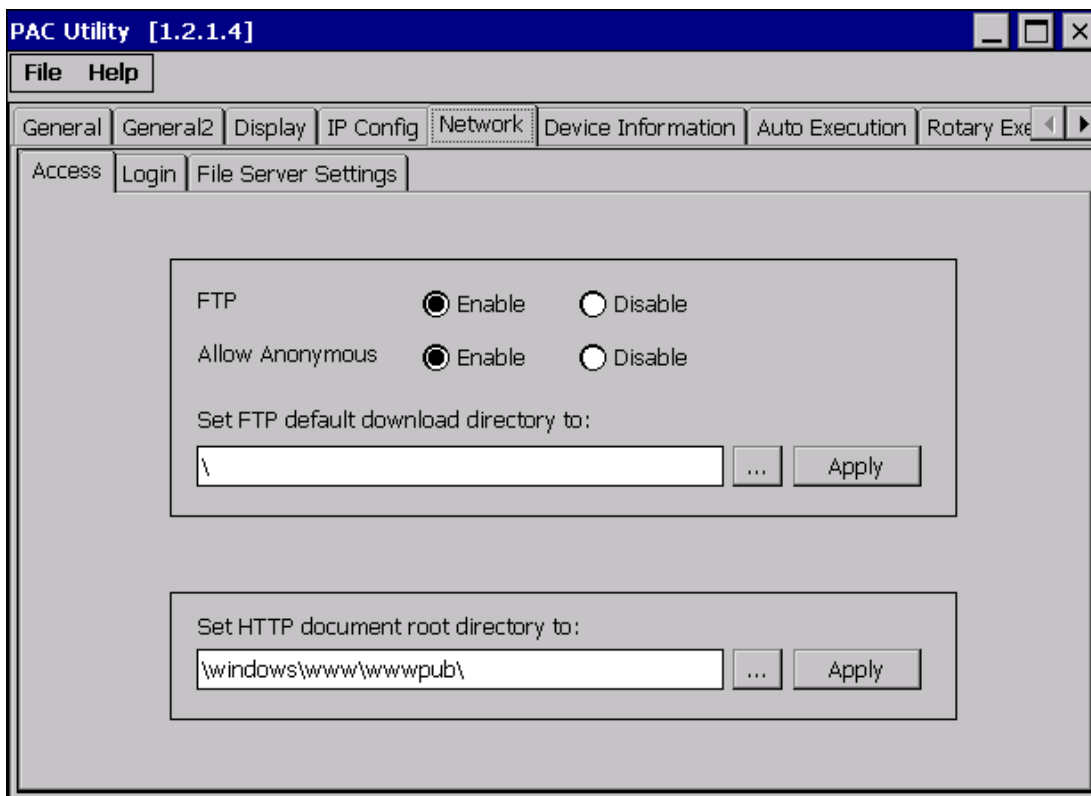

The tab use to	How to use
Enable or disable the FTP access	<p>Enable the FTP access: Select the Enable check box in the FTP field, and then click the Apply button.</p> <p>Disable the FTP access: Select the Disable check box in the FTP field, and then click the Apply button.</p>

The tab use to	How to use
Enable or disable anonymous FTP access	<p>Enable anonymous FTP access: Select the Enable check box in the Allow Anonymous field, and then click the Apply button.</p> <p>Disable anonymous FTP access: Select the Disable check box in the Allow Anonymous field, and then click the Apply button.</p>
Set the FTP directory path	Enter a new path in the Set FTP default download directory to: field, and then click the Apply button.
Set the HTTP directory path	Enter a new path in the Set HTTP document root directory to: field, and then click the Apply button.

Login

The **Login** tab provides functions to maintain the FTP accounts.

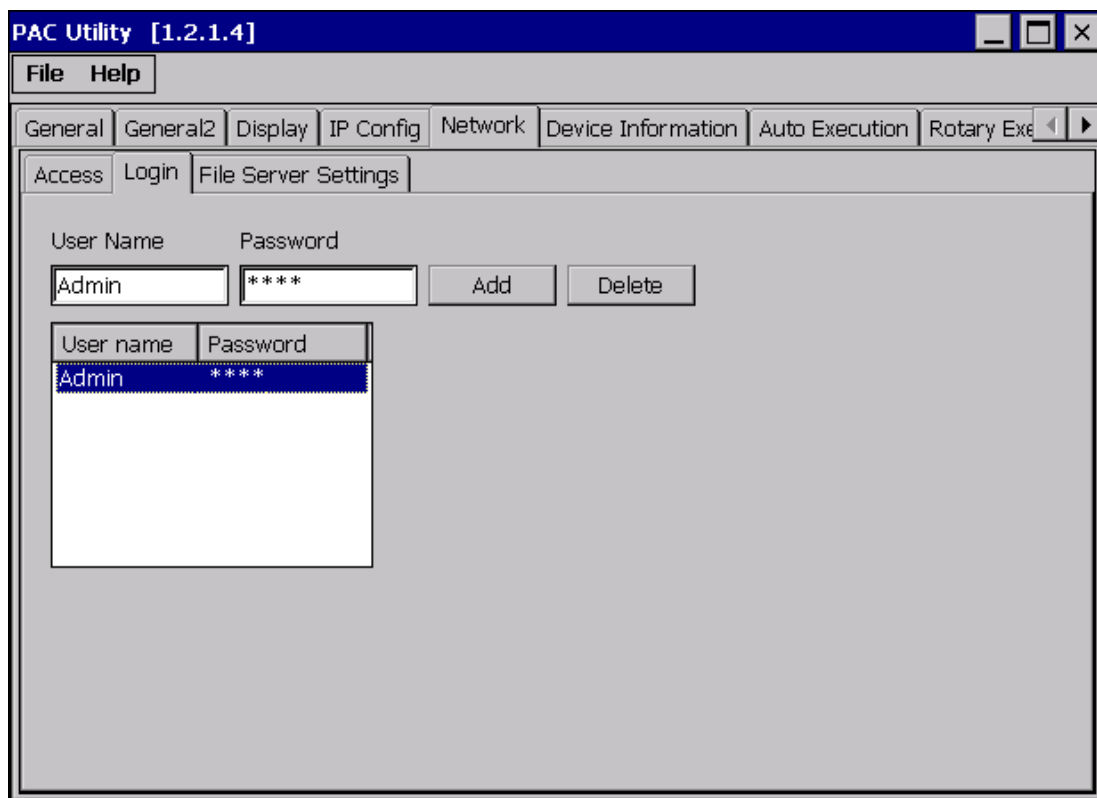

The tab use to	How to use
Maintain the FTP accounts	Refer to the Appendix C.1 How to add a user account to remote login the WP-8000-CE7 from PC.

File Server Settings

The **File Server Settings** tab provides functions to set the SMB server.

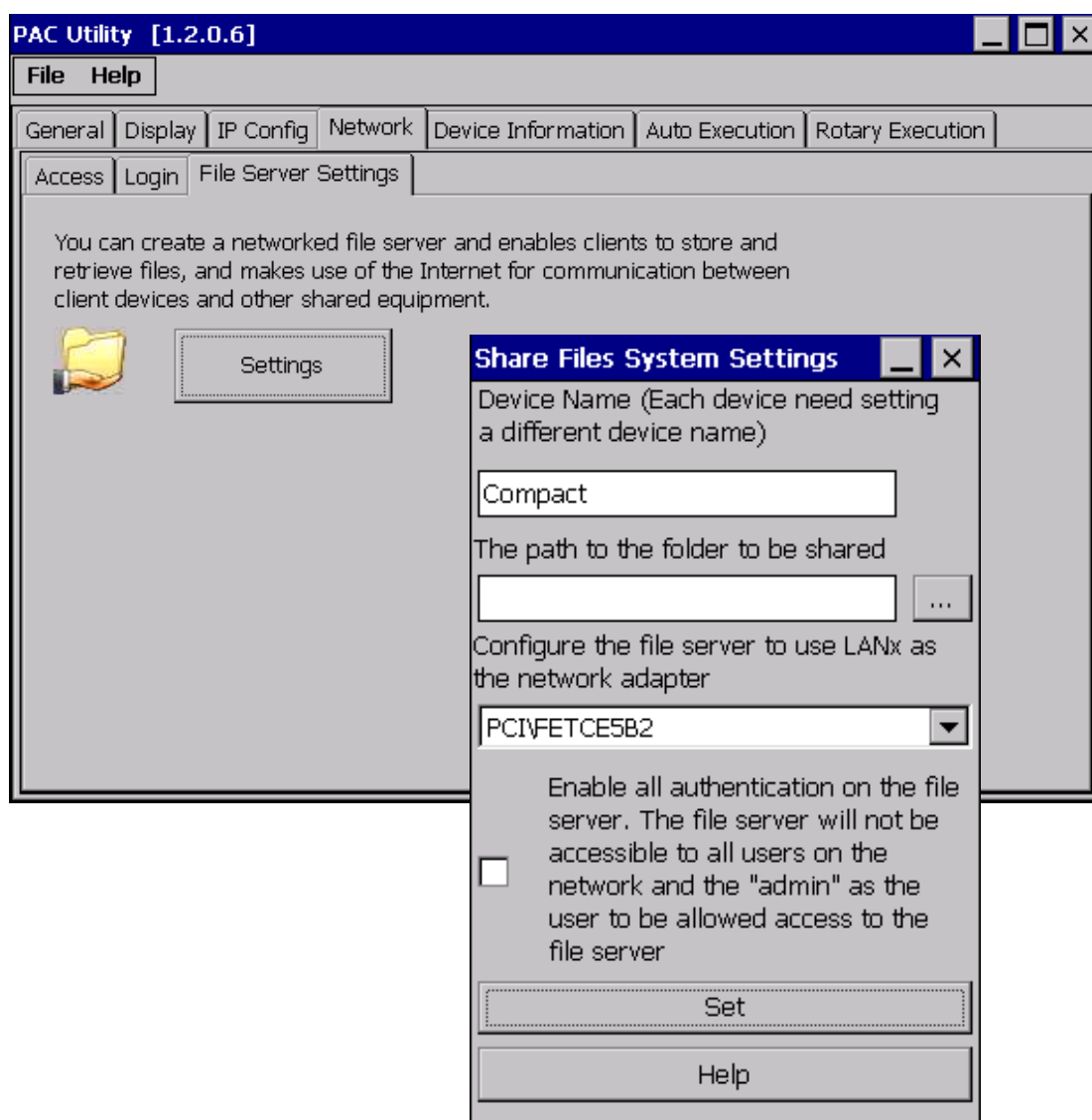

The tab use to

How to use

Set the SMB server

Click the Settings button to set the SMB server path.

3.1.8. Property Tab – Device Information

The **Device Information** tab provides functions to monitor necessary system information of the WP-8000-CE7. The information is the most important note of version control for upgrading system.

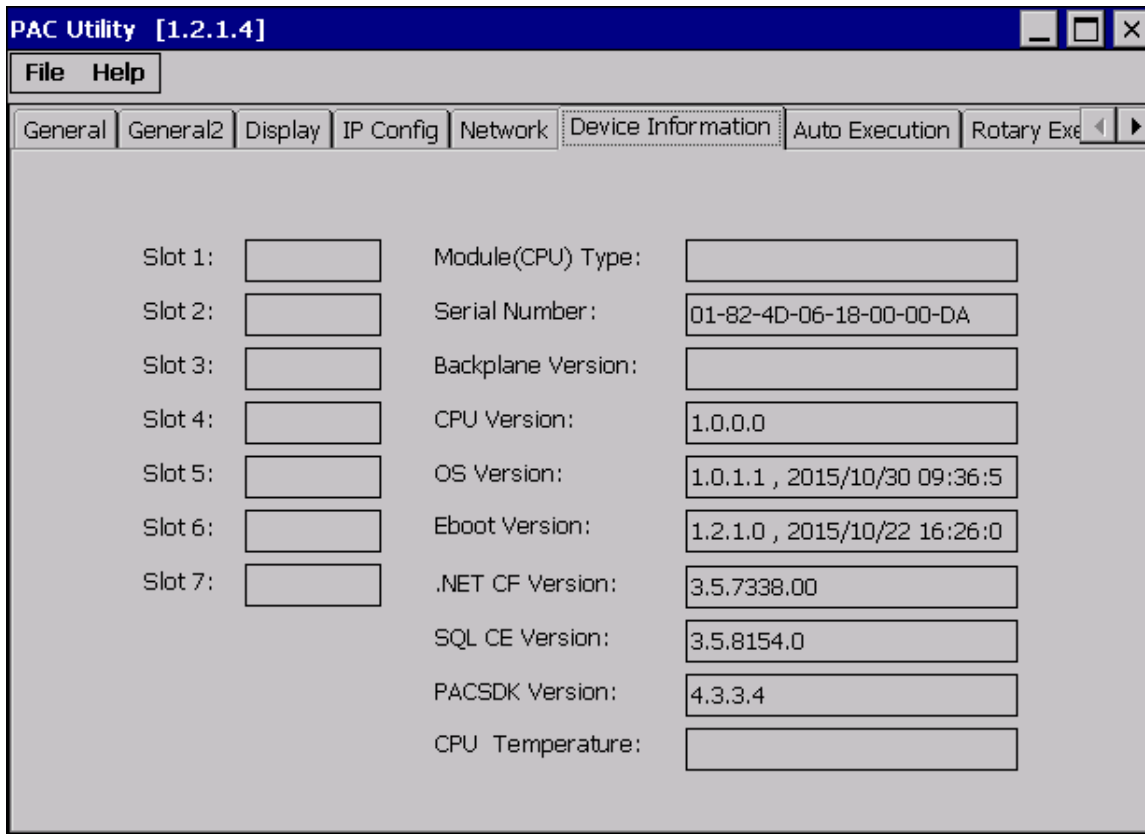

3.1.9. Property Tab – Auto Execution

The **Auto Execution** tab provides functions to configure programs running at WP-8000-CE7 startup, it allows users to configure ten execute files at most.

Tips & Warnings



The specific extensions are .exe and .bat, and they are executed in order of program 1, program 2, etc.

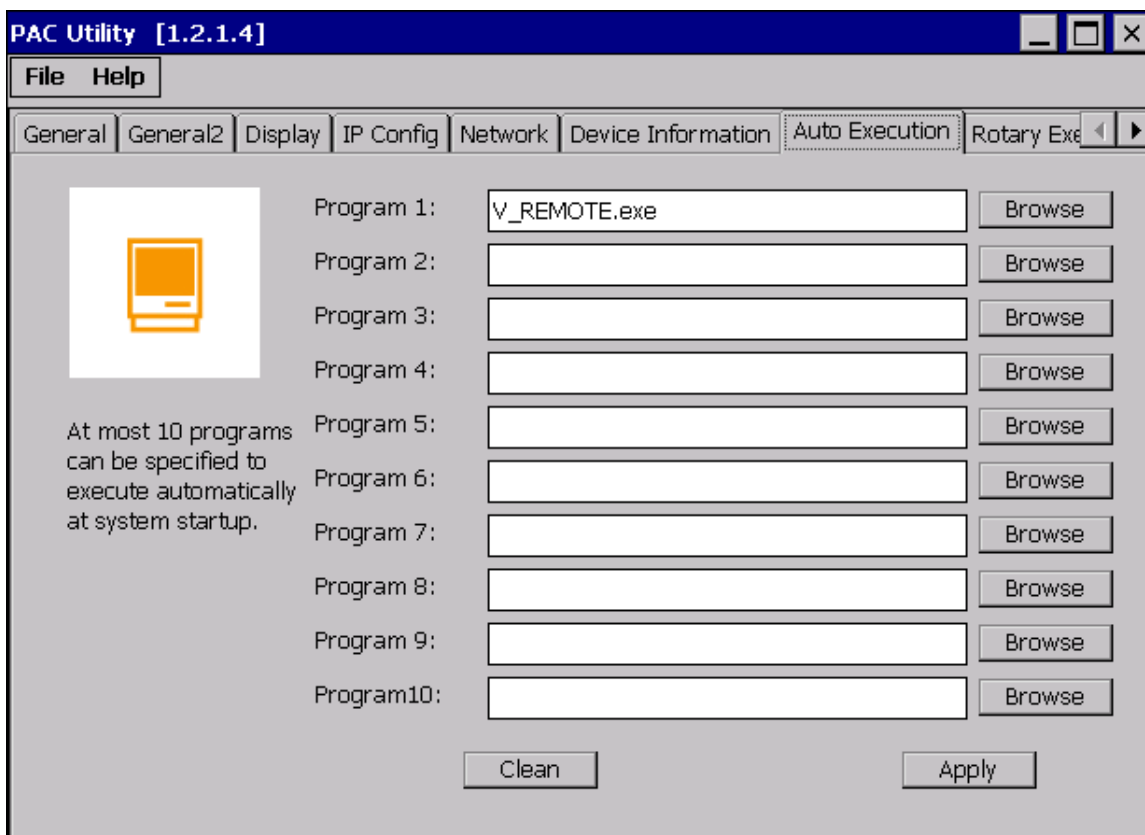

The tab use to	How to use
Configure programs running at startup	Click the Browse button to select the execute file which you want, and then click the Apply button.

3.1.10. Property Tab – Rotary Execution

The **Rotary Execution** tab provides functions to configure programs running at WP-8000-CE7 startup in one of the user defined mode, it allows users to configure ten execute files at most.

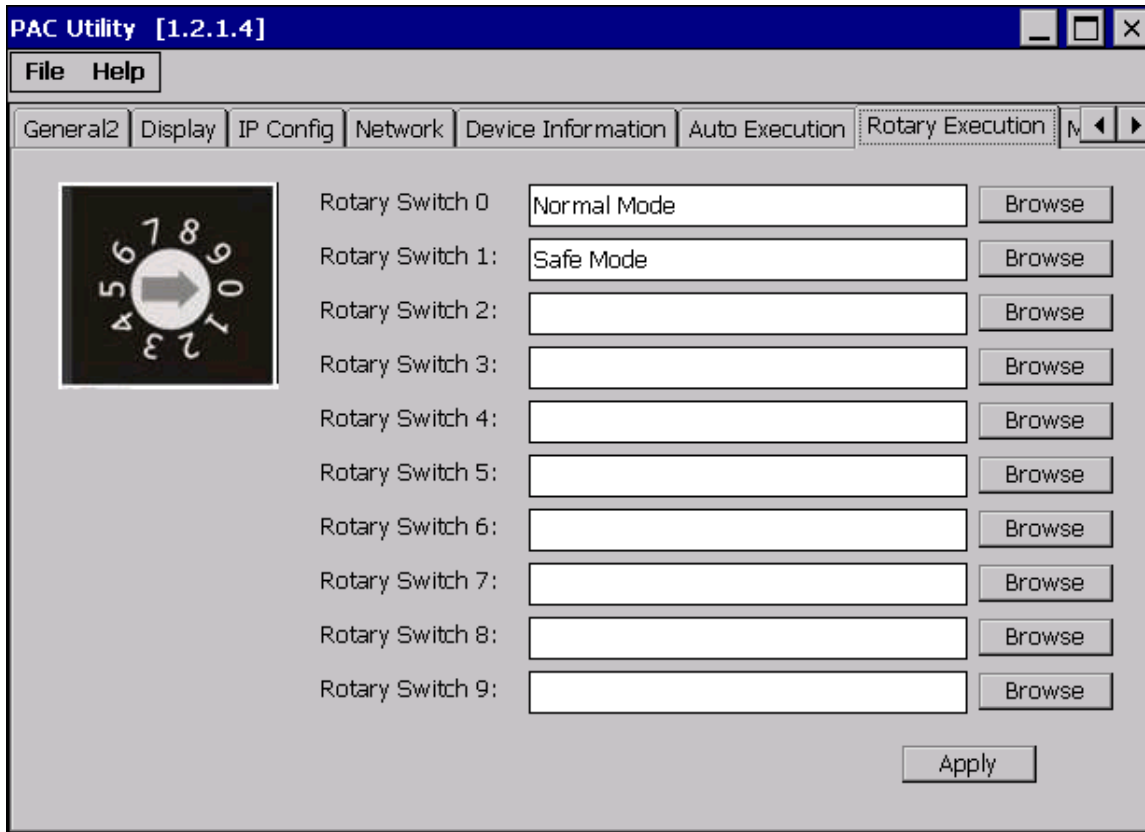

The tab use to	How to use
Configure programs running at startup in one of the user defined mode	Click the Browse button to select the execute file which you want, and then click the Apply button.

3.2. DCON Utility Pro

DCON Utility Pro enables users easily to configure and manage the I/O modules via Ethernet or serial ports (RS-232/RS-485).

For more information on how to use DCON Utility Pro to configure I/O modules, please refer to 2.7. Using DCON Utility Pro to Configure I/O Modules

For more detailed information on DCON Utility application, please refer to:

http://www.icpdas.com/en/product/guide+Software+Utility_Driver+DCON_Utility_Pro

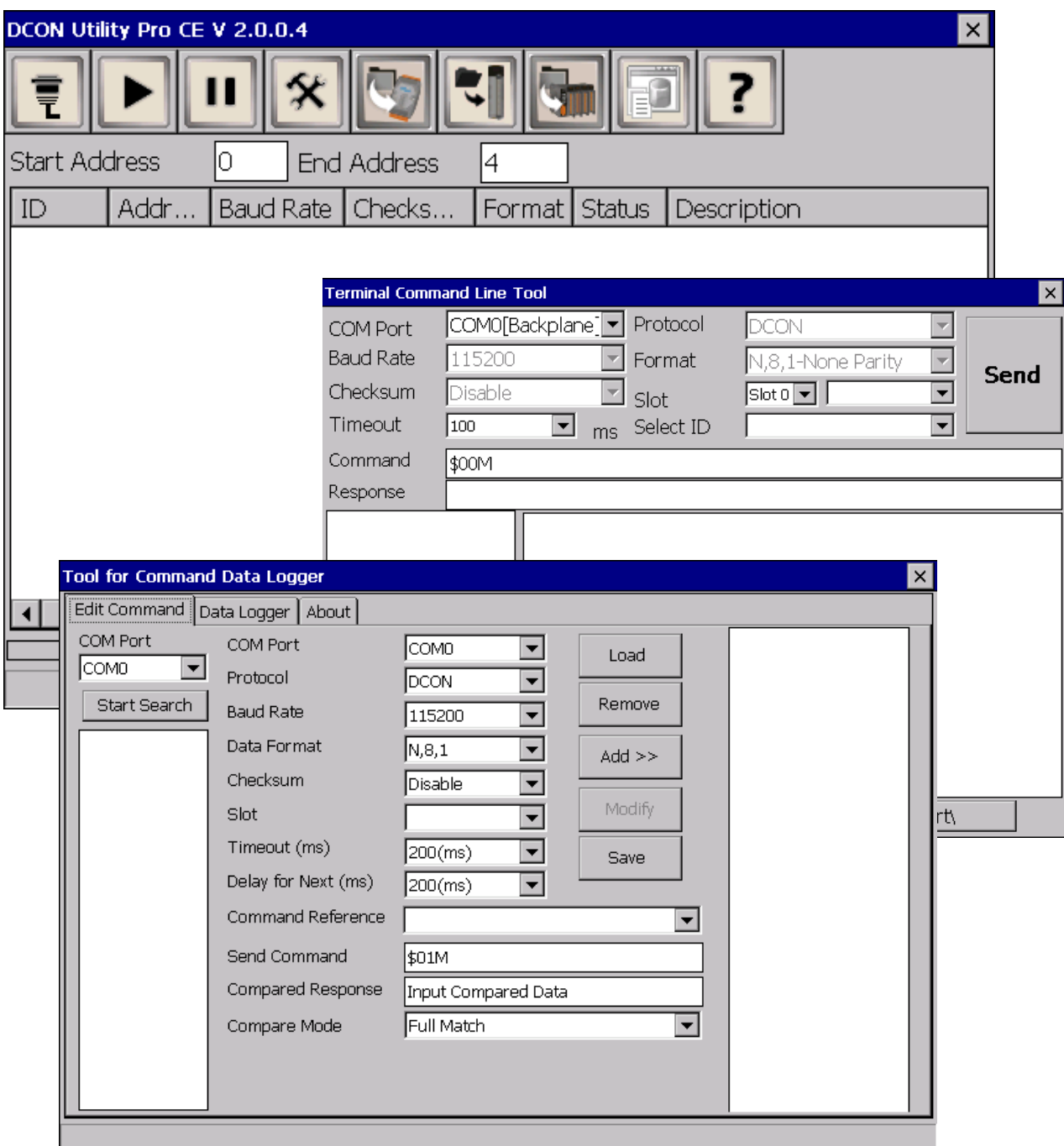

3.3. TaskMgr

The TaskMgr is a Windows CE application, which provides real time info on all processes and threads including System threads, similar in appearance to the Windows Task Manager.

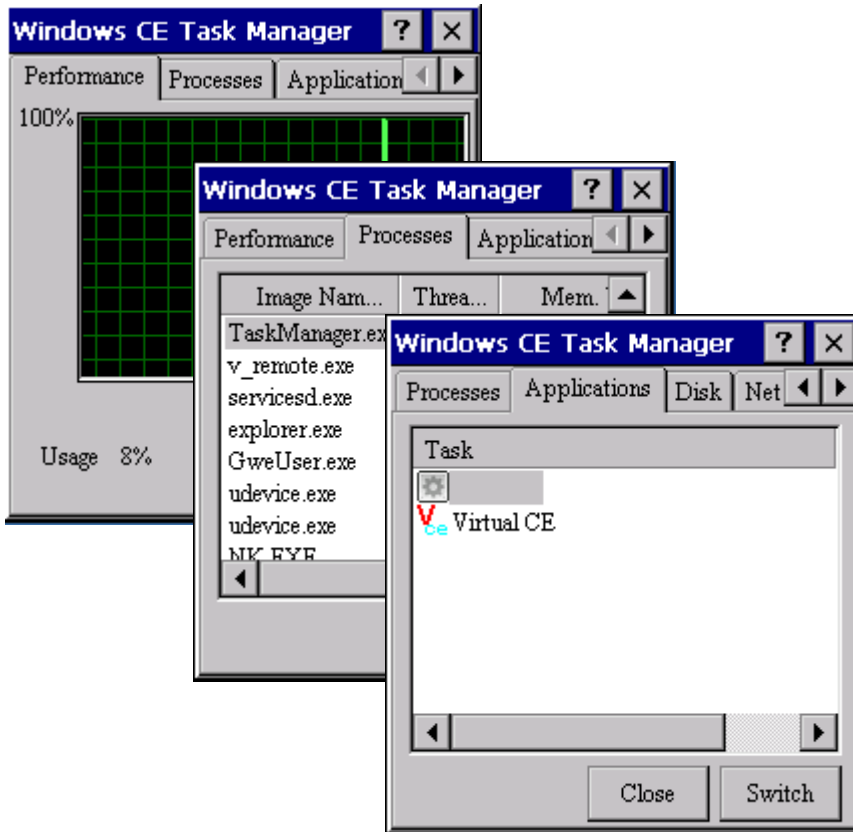

3.4. VCEP

ICP DAS VCEP is designed for managing your WP-8000-CE7 anywhere. No matter where you are, ICP DAS VCEP provides a convenient environment on the Desktop PC and lets you control your WP-8000-CE7 remotely.

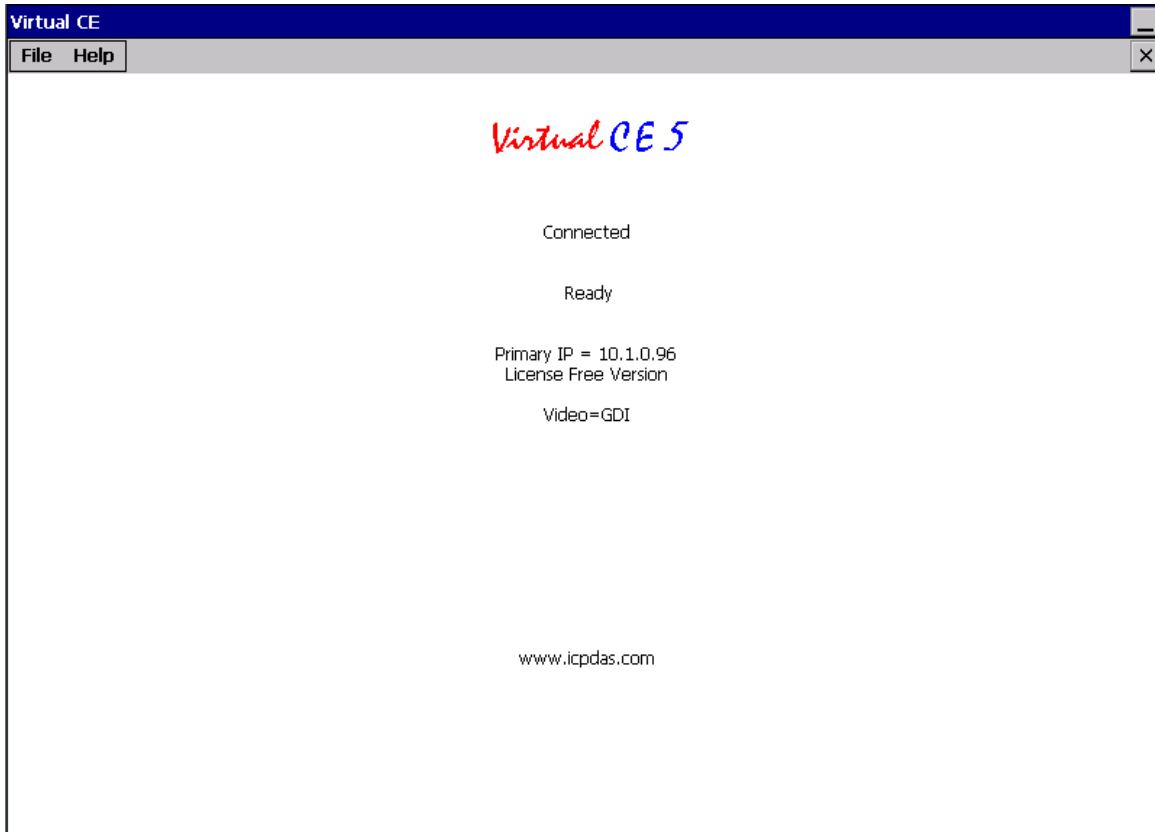

ICP DAS VCEP is composed of two main components: The **Server** which runs on WP-8000-CE7 and the **Client** which runs on a Desktop PC.

Once a connection is established between the client and server (initiated by the client), the client will periodically send requests for screen updates and send mouse/key click information to the server to simulate.

Each video frame is inter-compressed against the previous frame and then intra-compressed with a modified LZW scheme to minimize the amount of data transmitted from server to client.

For more detailed information on VCEP application, please refer to <http://www.icpdas.com/en/product/guide+Software+Applications+VCEP> (Virtual CE Pro)

3.5. Remote_Display

The **Remote Display** allows WP-8000-CE7 to be controlled and monitored from a remote location.

This tool is composed of two parts, a client and a server. The server is a program named `cerdisp.exe` running on WP-8000-CE7. The client is a PC-based program named `cerhost.exe` running on the PC.



cerdisp



cerhost

Once a connection is established between the client and server (initiated by the client), the client will periodically send requests for screen updates and send mouse/key click information to the server to simulate.

3.6. SendToCOM

The **SendToCOM** uses the serial port to communicate with expansion module. To use the SendToCOM, you can send data to expansion module through the serial port, and receive data from other device through the serial port.

For more information about these commands for communicating with expansion module, please refer to:

CD:\WinPAC\napdos\io_module\87k_high_profile_modules.htm

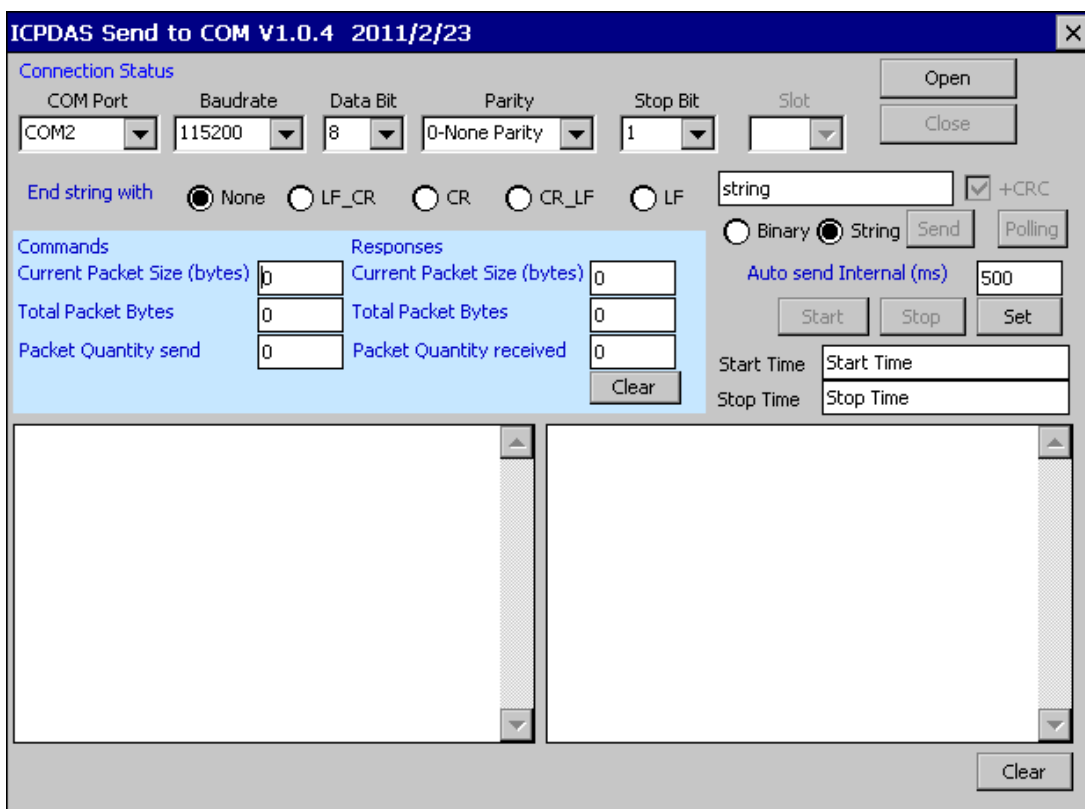

3.7. RegEdit

The **RegEdit** provides a hierarchical representation of the registry on a target computer, similar in appearance to the Windows Registry Editor. The standard registry roots are represented; you can add keys beneath a root to point to existing registry keys, or you can add your own keys. Values can be changed for existing keys, or added for new keys, and default keys can be specified. For more information, see Registry Settings Management in Deployment.

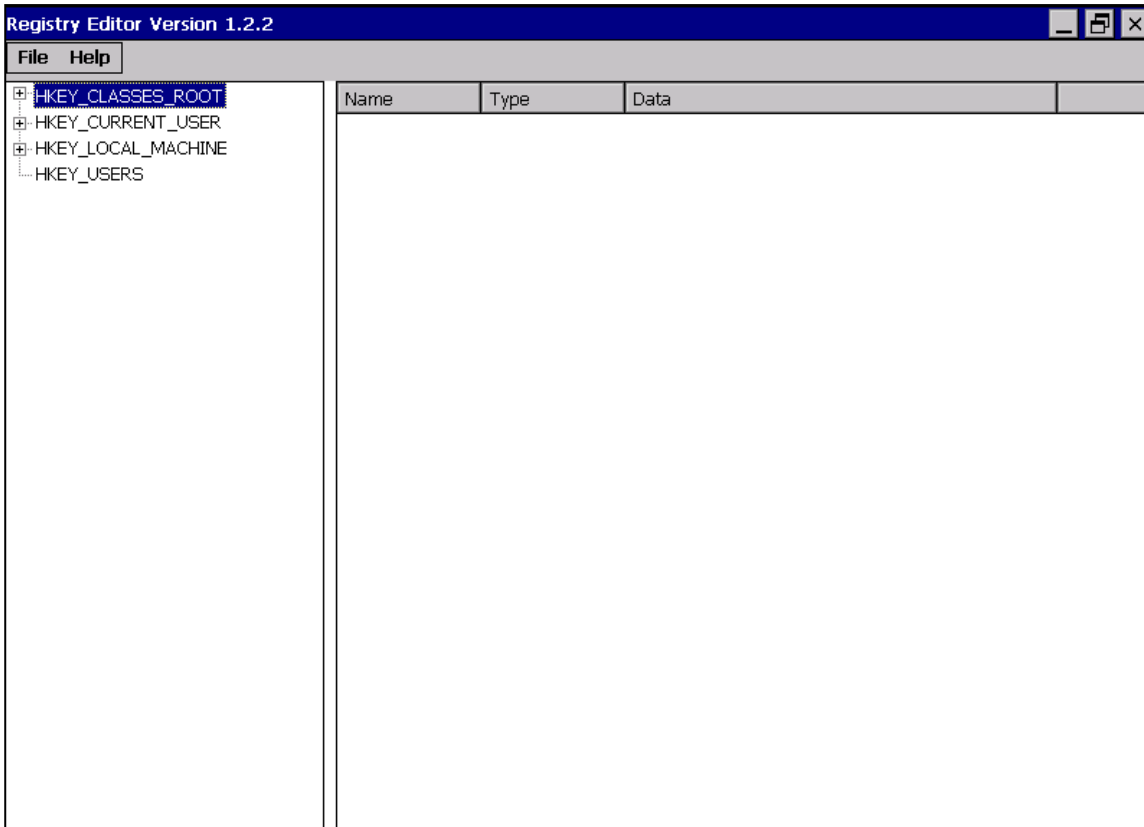

3.8. ISQLW35

The **ISQLW35** is a Windows Embedded Compact 7 functionality that implements SQL Server Compact 3.5 Query.

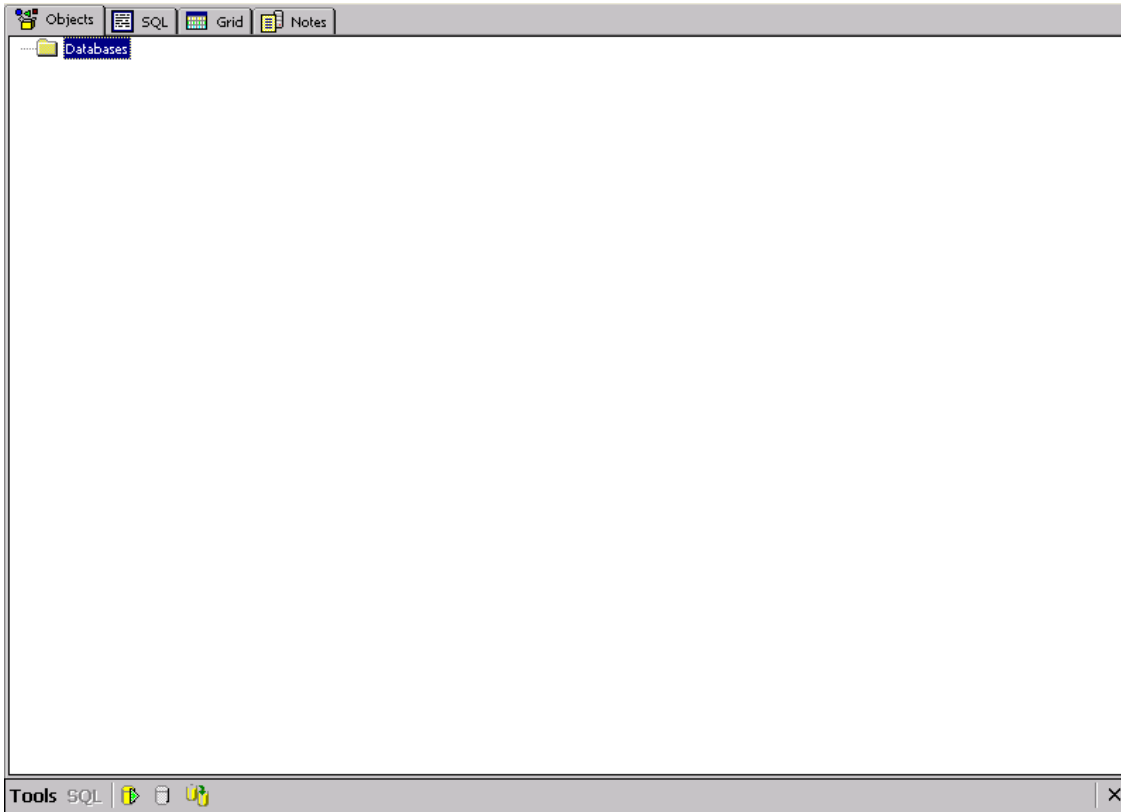

3.9. INotepad

The **INotepad** is a common text-only editor. The resulting files have no format tags or styles.

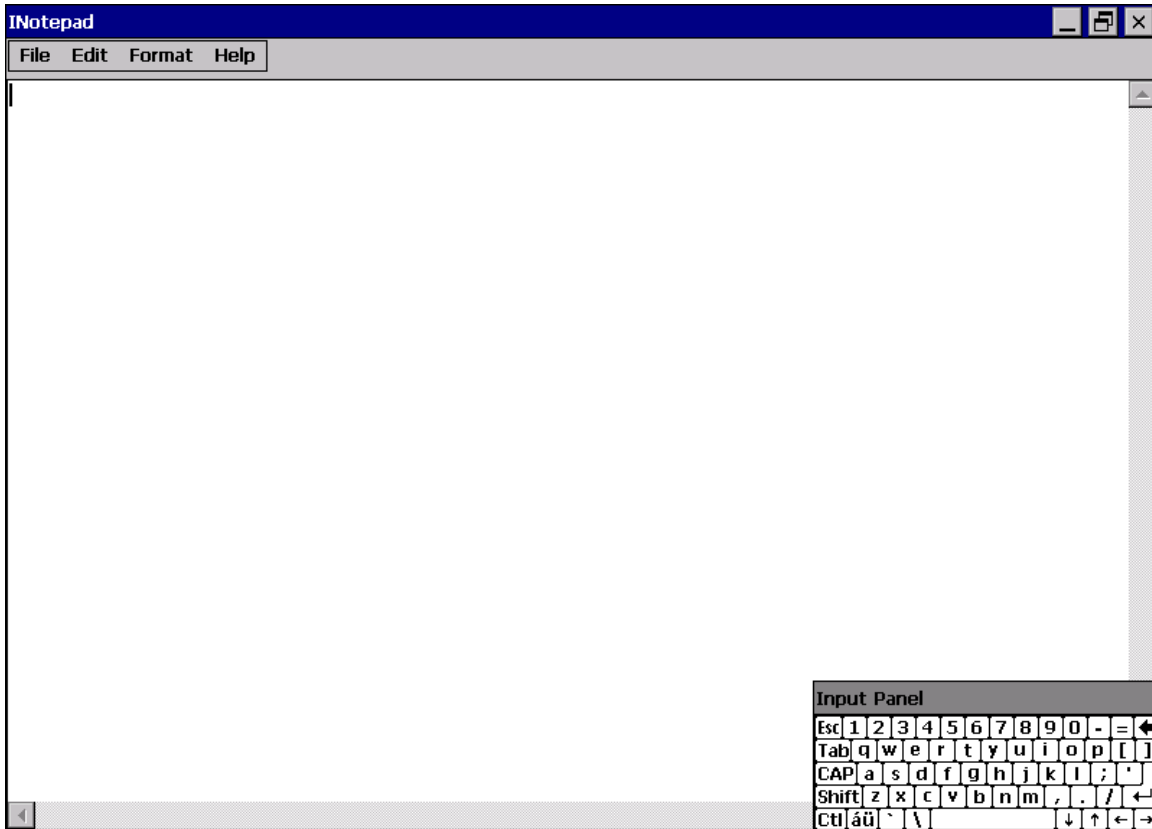

4. Your First WP-8000-CE7 Program

This chapter provides a guided tour that describes the steps needed to set-up a development environment, download, install, configure for user programming with WP-8000-CE7 modules.

4.1. Setting up the Development Environment

Before writing your first program, ensure that you have the necessary development tool and the corresponding SDKs are installed on your system.

4.1.1. Preparing the Development Tools and Programming Languages

WP-8000-CE7 is a Windows CE-based device that supports three programming languages for developing Windows CE applications.

- Visual Basic.NET
- Visual C#
- Visual C++

Development Tools

WP-8000-CE7 supports the application development with the Professional Edition application of Visual Studio 2008.



Tips & Warnings



There are some updates for Visual Studio 2008 to provide support for Windows Embedded Compact 7.

If you have Professional Edition of Visual Studio 2008 are installed, make sure all of the following package are installed

1. Visual Studio 2008 Service Pack 1

<http://www.microsoft.com/en-us/download/details.aspx?id=10986>

2. Visual Studio 2008 update for Windows Embedded Compact 7

<http://www.microsoft.com/en-us/download/confirmation.aspx?id=11935>

3. Windows Embedded Compact 7 ATL Update for Visual Studio 2008 SP1

<http://support.microsoft.com/kb/2468183/en-us>

4.1.2. Installing the WP-8000-CE7 SDK

The WP-8000-CE7 SDK offers several APIs for customizing the standard features and integrating with other applications, devices and services.

Step 1: Get the latest version of the WP-8000-CE7 SDK, AM335x_WINCE7_SDKV100B03

The WP-8000-CE7 SDK can be found from the CD that was provided with the package or by downloading the latest version from ICP DAS web site.

CD:\WinPAC_AM335x\WP-8x2x\SDK\PlatformSDK\

http://ftp.icpdas.com/pub/cd/winpac_am335x/wp-8x2x/sdk/platformsdk/

Step 2: Execute the AM335x_WINCE7_SDK_YYYYMMDD.msi

Follow the prompts until the installation process is complete.

Step 3: Execute the VisualStudioDeviceWindowsEmbeddedCompact7

Follow the prompts until the installation process is complete.

4.1.3. Setting up the Global Compiler Settings (for Visual C++)

The directories can be specified where the compiler will search for include files and libraries.

Step 1: Start Visual Studio 2008



Step 2: On the Tools menu, click Options...

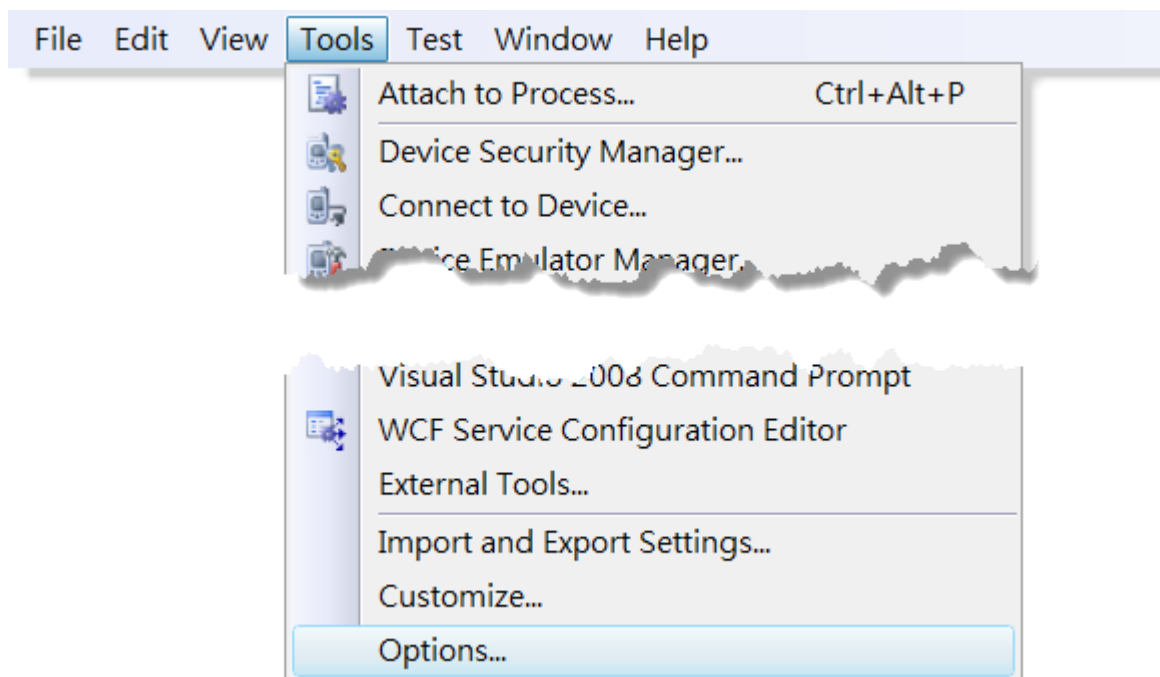

Step 3: In the Options dialog box, expand the Projects folder, and then click the VC++ Directories

Step 4: In the Show directories for: drop-down list, select Include files

Step 5: Use the buttons in the Options dialog box to add additional include paths

The path of “\$(VCInstallDir)ce7\include” and “\$(VCInstallDir)ce7\atlmfc\include” must be moved to the top of the list.

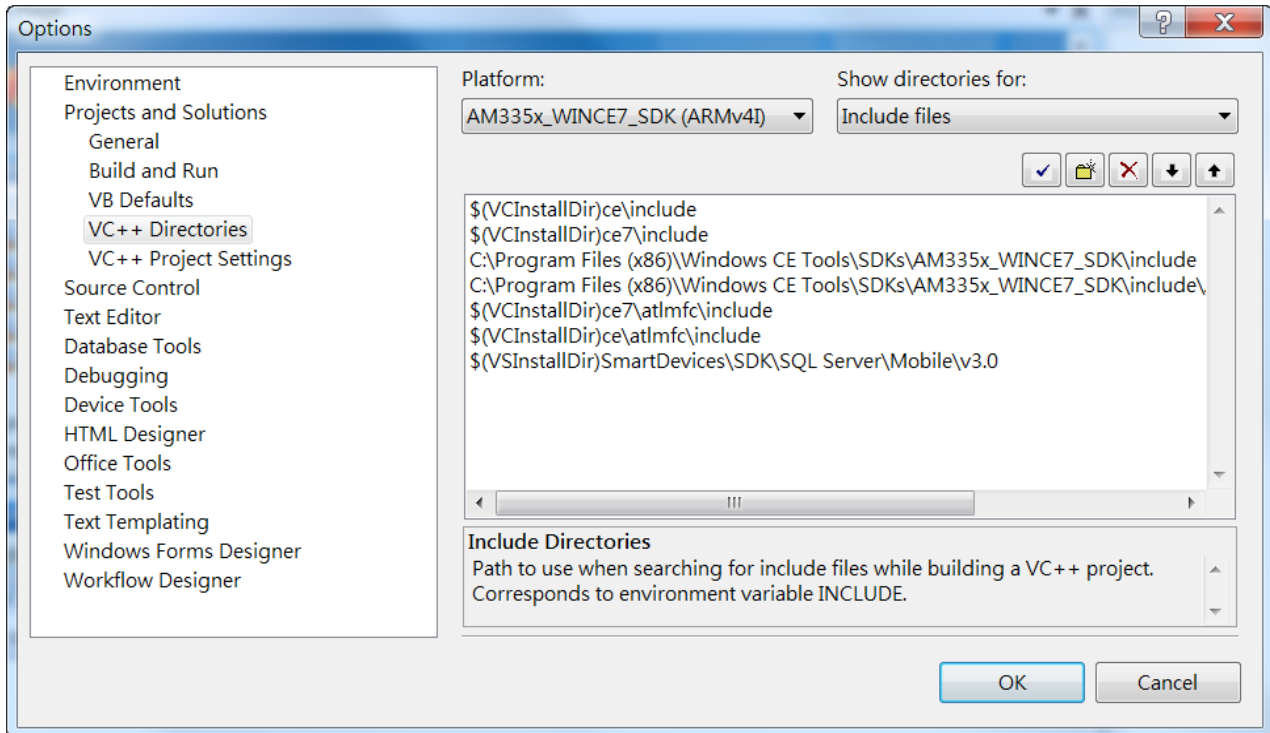

4.2. First WP-8000-CE7 Program in VB.NET

The best way to learn programming with WP-8000-CE7 is to actually create a WP-8000-CE7 program.

The example below demonstrates how to create a demo program running on WP-8000-CE7 with VB.NET.

To create a demo program with VB.NET that includes the following main steps:

1. Create a new project
2. Specify the path of the PAC reference
3. Add the control to the form
4. Add the event handling for the control
5. Upload the application to WP-8000-CE7
6. Execute the application on WP-8000-CE7

All main steps will be described in the following subsection.

In this tutorial, we will assume that you have installed WP-8000-CE7 SDK on PC and used the Visual Studio 2008 for application development.

4.2.1. Create a new project

The Visual VB.net project template is a composite control that you use in this example creates a new project with this user control.

Step 1: Start Visual Studio 2008



Step 2: On the File menu, point to New, and then click Project

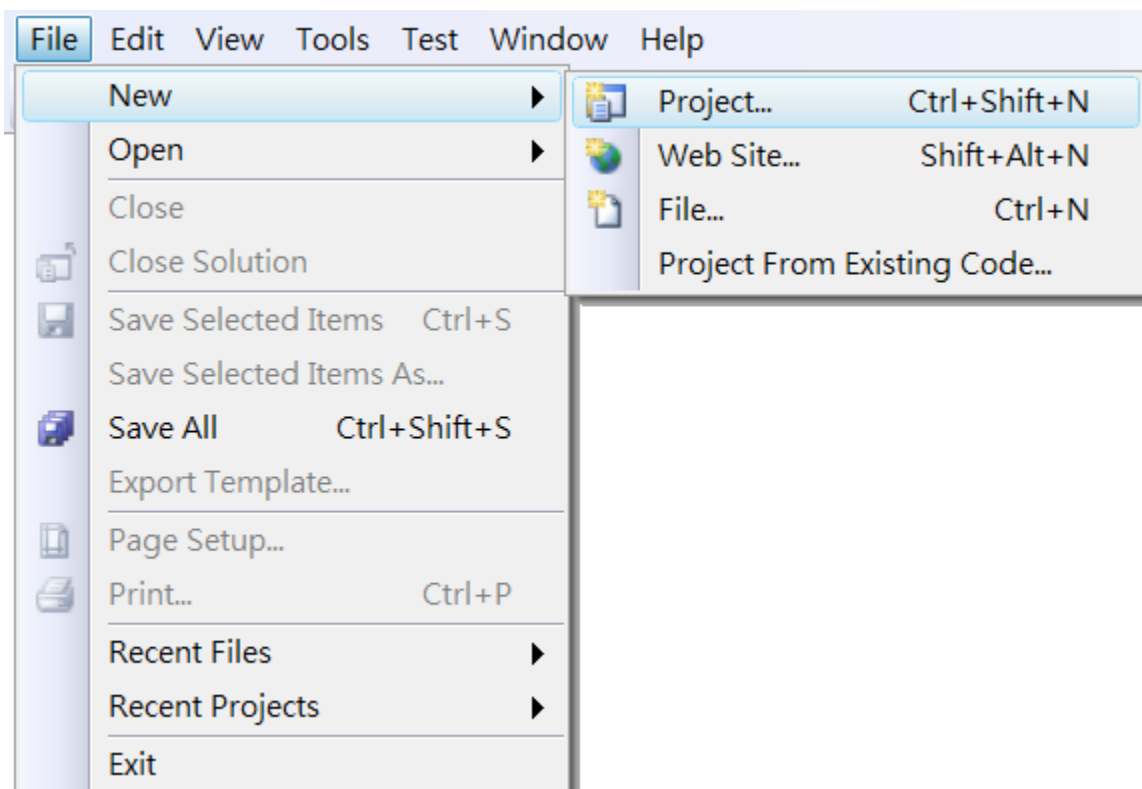

Step 3: In the Project types pane, expand Visual Basic node and select Smart Device

Step 4: In the list of Templates, select Smart Device Project

Step 5: Specify a name and a location for the application and then click OK

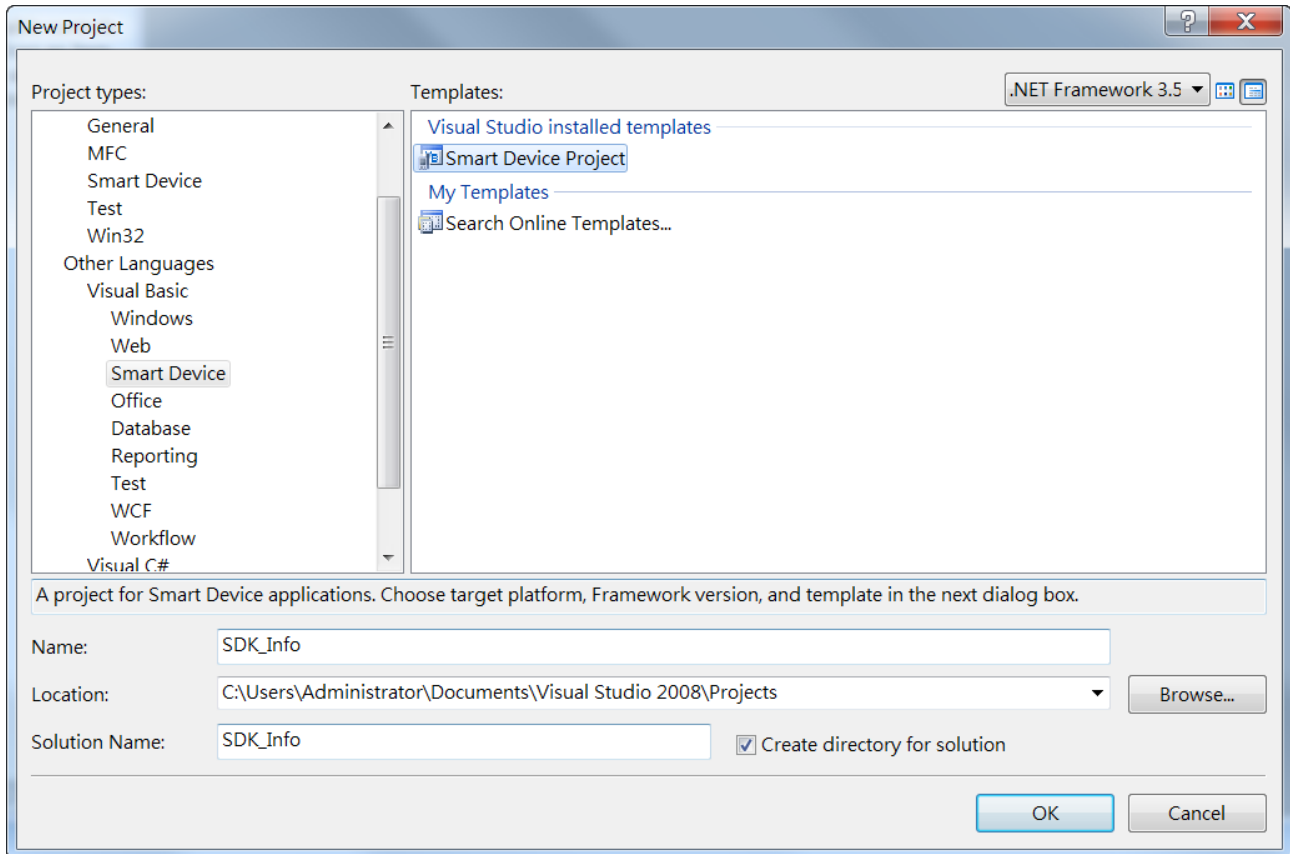

Step 6: In the Target platform, select Windows CE

Step 7: In the .NET Compact Framework version, select .NET Compact Framework Version 3.5.

Tips & Warnings



Windows CE7 only supports .NET Compact Framework Version 3.5, if your application uses .NET Compact Framework Version 2.0 there is no guarantee that the program will function correctly.

Step 8: In the list of templates, select Device Application. Click OK

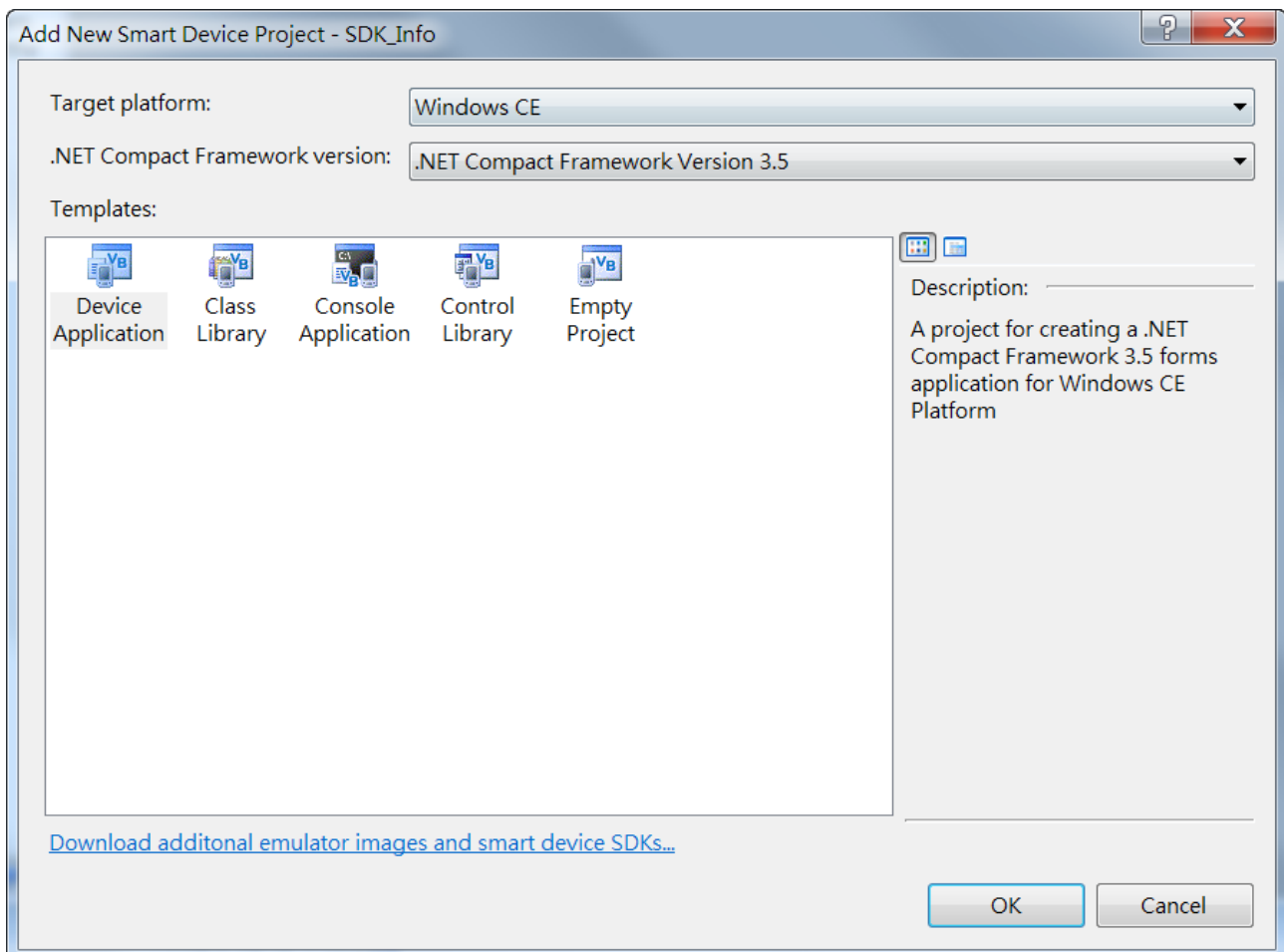

4.2.2. Specify the path of the PAC reference

The PAC SDK provides a complete solution to integrate with WP-8000-CE7 and it's compatible with Visual C#, Visual Basic.NET and C++. In order to use a component in your application, you must first add a reference to it.

Step1: Get the PACNET.dll



The PACNET.dll can be found from the CD that was provided with the package or by downloading the latest version from ICP DAS web site.

CD:\WinPAC_AM335x\WP-8x2x\SDK\PACNET\

http://ftp.icpdas.com/pub/cd/winpac_am335x/wp-8x2x/sdk/pacnet/

Step 2: On the Project menu, and then click Add Reference...

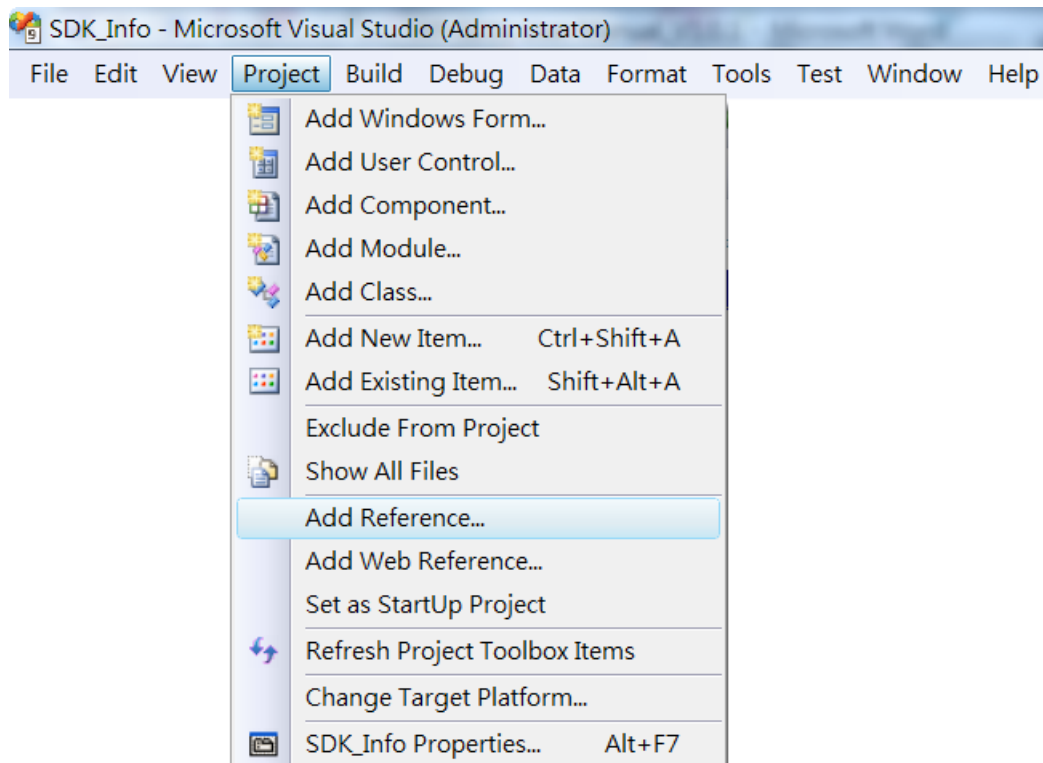

Step 3: On the Browse tab and browse to where the PACNET.dll are installed, and then click OK

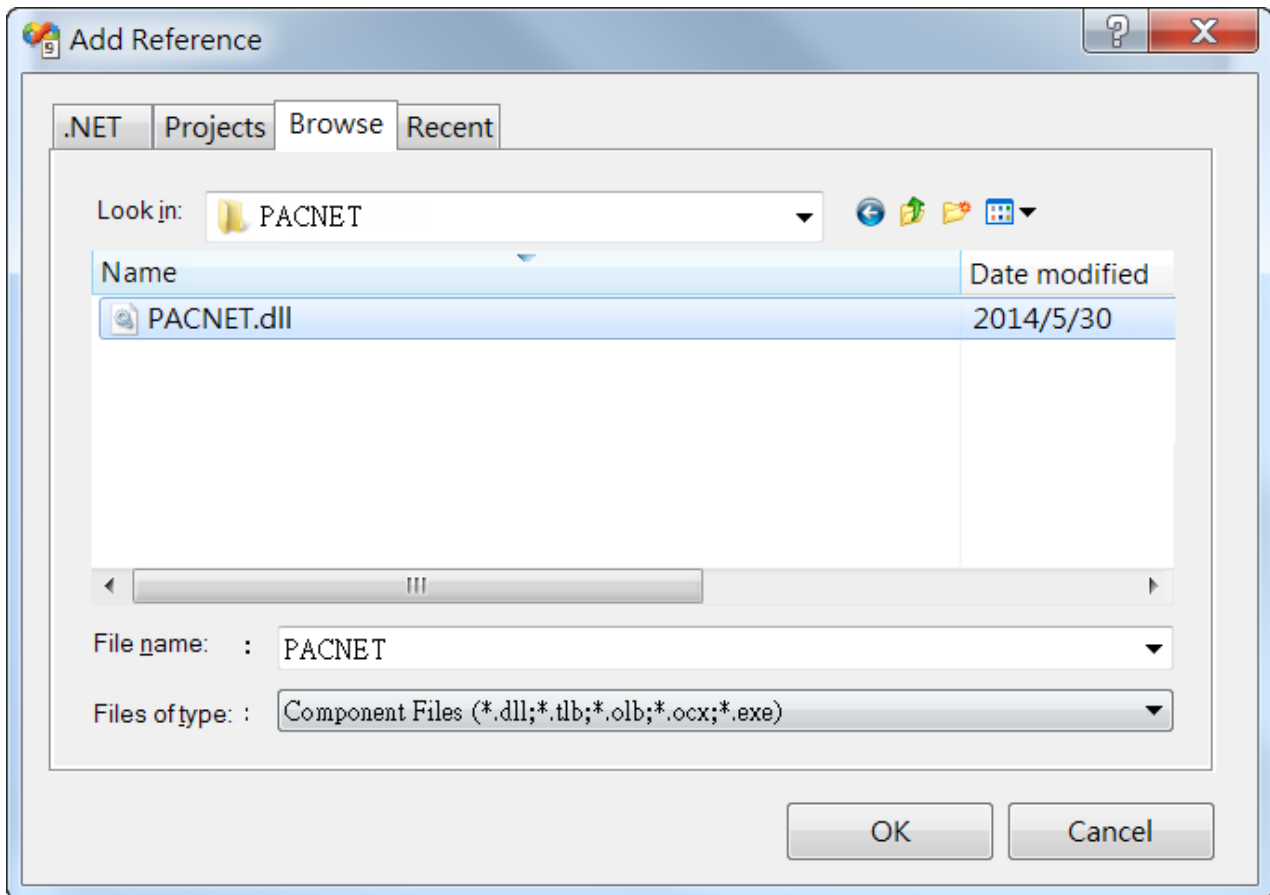

4.2.3. Add the control to the form

You can drag various controls from the Toolbox onto the form. These controls are not really "live"; they are just images that are convenient to move around on the form into a precise location.

After you add a control to your form, you can use the Properties window to set its properties, such as background color and default text. The values that you specify in the Properties window are the initial values that will be assigned to that property when the control is created at run time.

Step 1: On the Toolbox panel, drag a Button control onto the form

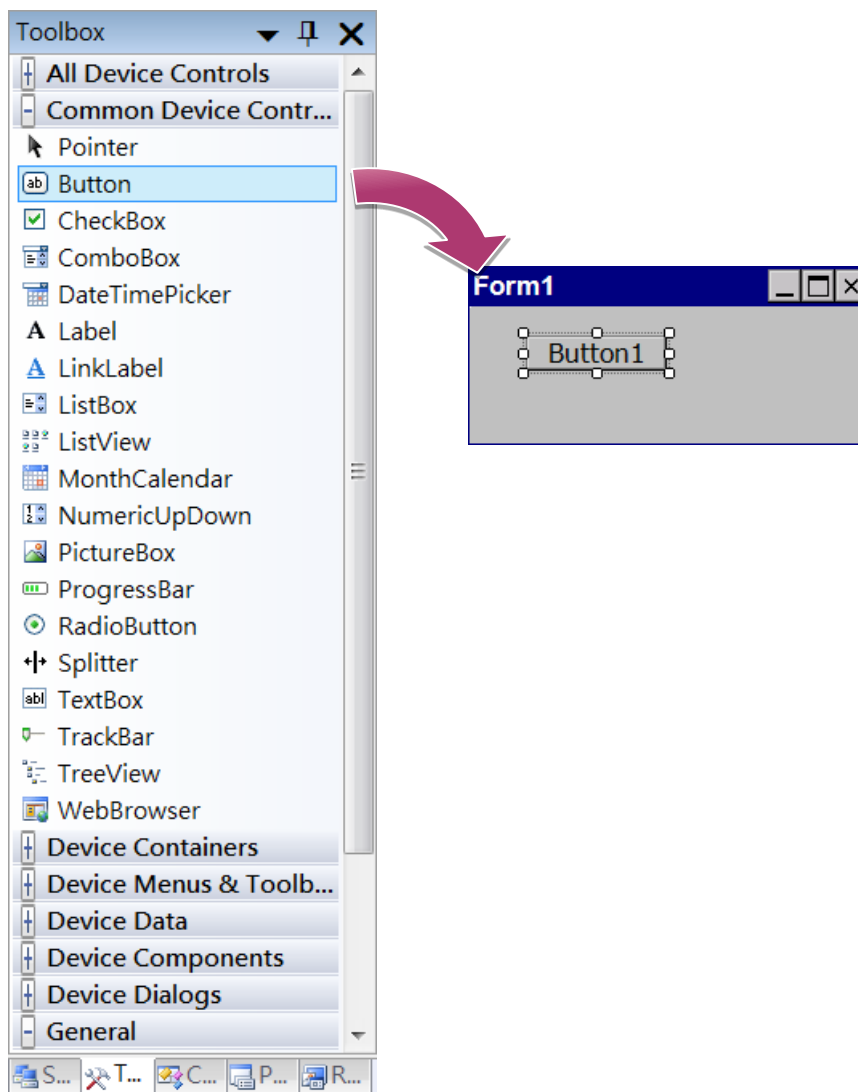

Step 2: On the Properties panel, type Check the SDK version in the Text field

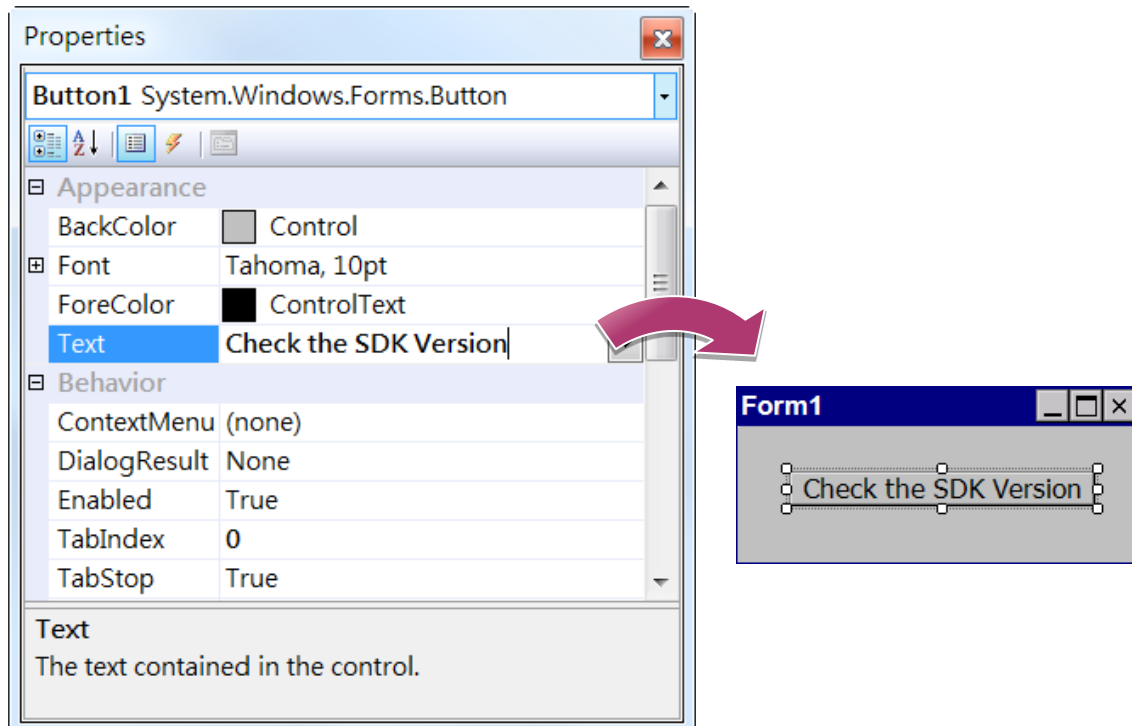

4.2.4. Add the event handling for the control

You have finished the design stage of your application and are at the point when you can start adding some code to provide the program's functionality.

Step 1: Double-click the button on the form

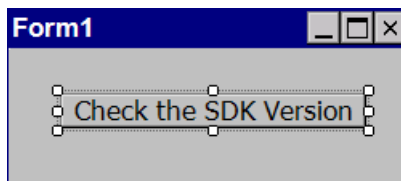

Step 2: Inserting the following code

```
Dim data(30) As Byte
PACNET.Sys.GetSDKVersion(data)
MessageBox.Show(PACNET.MISC.WideString(data))
```

```
Public Class Form1
    Private Sub Button1_Click(ByVal sender As System.Object, ByVal e As EventArgs)
        Dim data(30) As Byte
        PACNET.Sys.GetSDKVersion(data)
        MessageBox.Show(PACNET.MISC.WideString(data))
    End Sub
End Class
```

Tips & Warnings



The "PACNET" of "using PACNET" is case- sensitive.

4.2.5. Upload the application to WP-8000-CE7

WP-8000-CE7 supports FTP server service. You can upload files to WP-8000-CE7 or download files from a public FTP server.

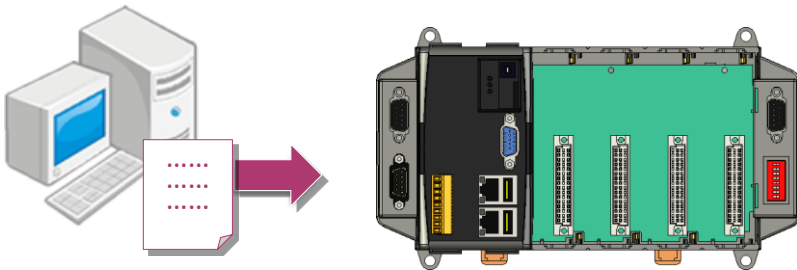

Step 1: On the Build menu, and then click Build [Project Name]

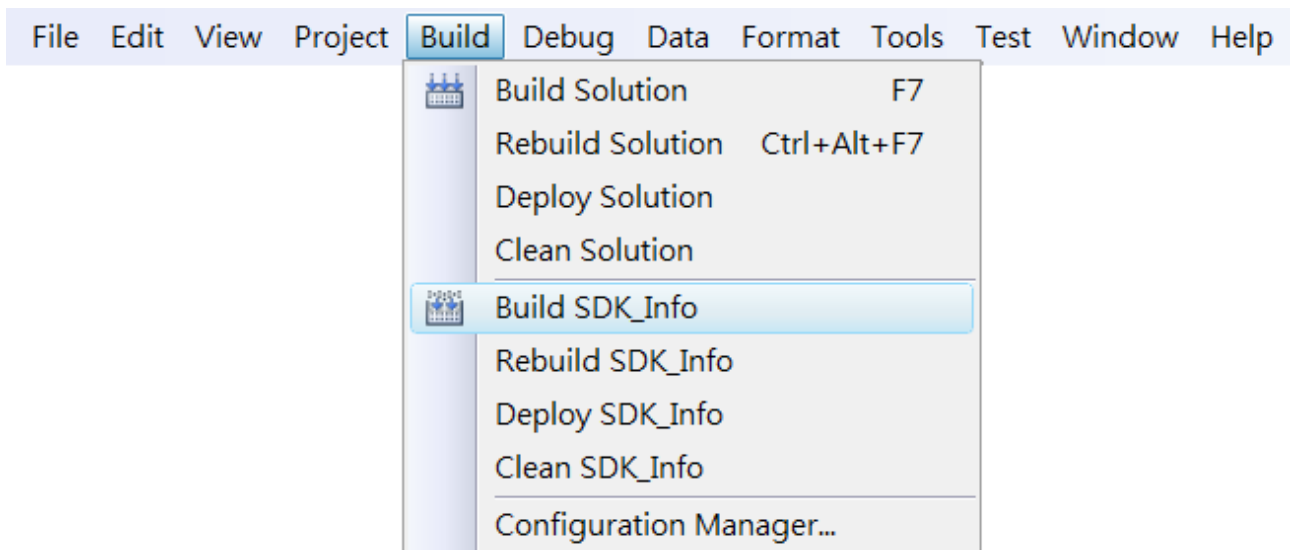

Step 2: Open the browser and type the IP address of WP-8000-CE7

Step 3: Upload the application and the corresponding PACNET.dll files to WP-8000-CE7

Tips & Warnings



For applications programming in C# and VB.net with .net compact framework, when executing these application on WP-8000-CE7, the corresponding PACNET.dll must be in the same directory as the .exe file.

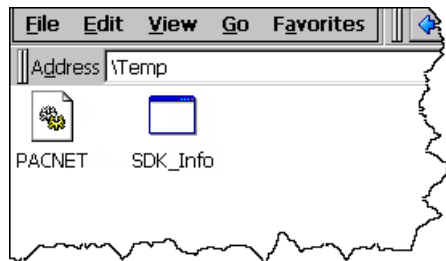

4.2.6. Execute the application on WP-8000-CE7

After uploading the application to WP-8000-CE7, you can just double-click it on WP-8000-CE7 to execute it.

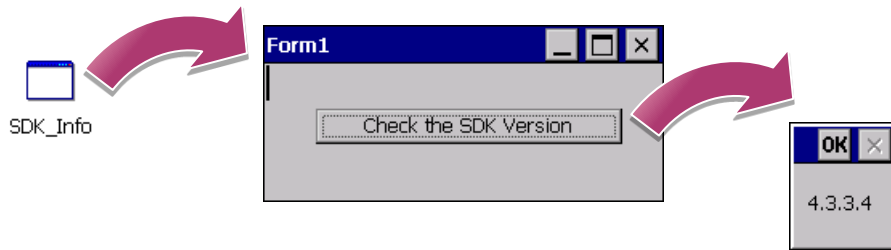

4.3. First WP-8000-CE7 Program in Visual C#

The best way to learn programming with WP-8000-CE7 is to actually create a WP-8000-CE7 program.

The example below demonstrates how to create a demo program running on WP-8000-CE7 with Visual C#.

To create a demo program with Visual C# that includes the following main steps:

1. Create a new project
2. Specify the path of the PAC reference
3. Add the control to the form
4. Add the event handling for the control
5. Upload the application to WP-8000-CE7
6. Execute the application on WP-8000-CE7

All main steps will be described in the following subsection.

In this tutorial, we will assume that you have installed WP-8000-CE7 SDK on PC and used the Visual Studio 2008 for application development.

4.3.1. Create a new project

The Visual C# project template is a composite control that you use in this example creates a new project with this user control.

Step 1: Start Visual Studio 2008



Step 2: On the File menu, point to New, and then click Project

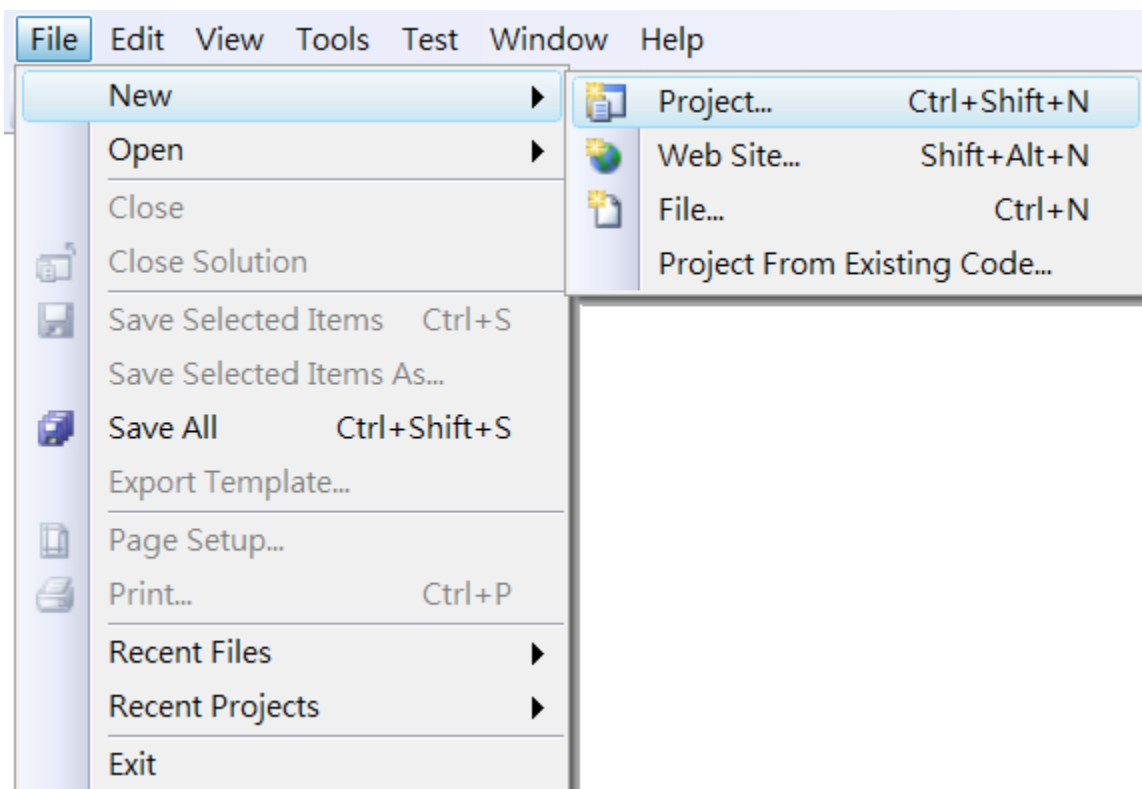

Step 3: In the Project types pane, expand Visual C# node and select Smart Device

Step 4: In the list of Templates, select Smart Device Project

Step 5: Specify a name and a location for the application and then click OK

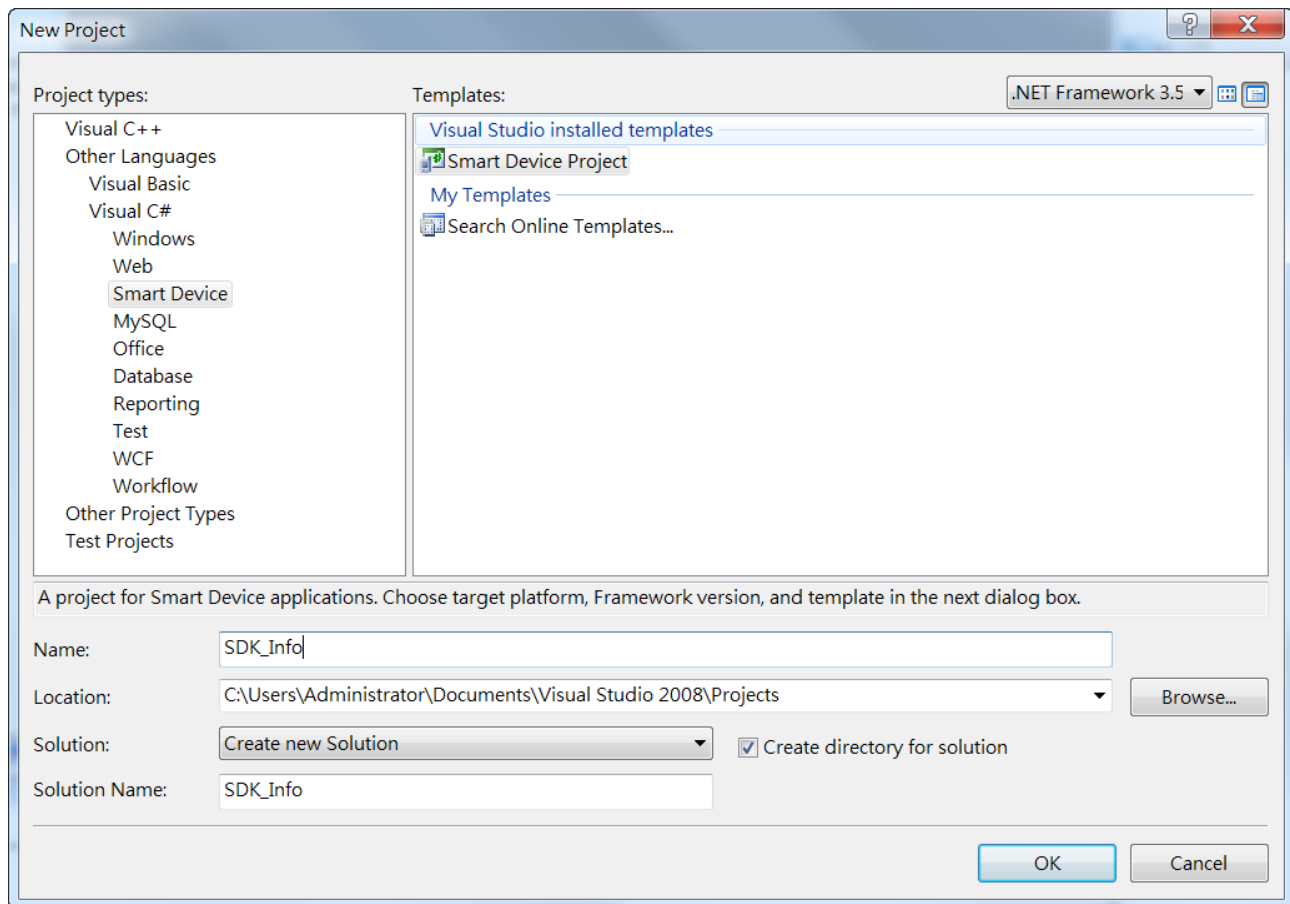

Step 6: In the Target platform, select Windows CE

Step 7: In the .NET Compact Framework version, select .NET Compact Framework Version 3.5.

Tips & Warnings



Windows CE7 only supports .NET Compact Framework Version 3.5, if your application uses .NET Compact Framework Version 2.0 there is no guarantee that the program will function correctly.

Step 8: In the list of templates, select Device Application. Click OK

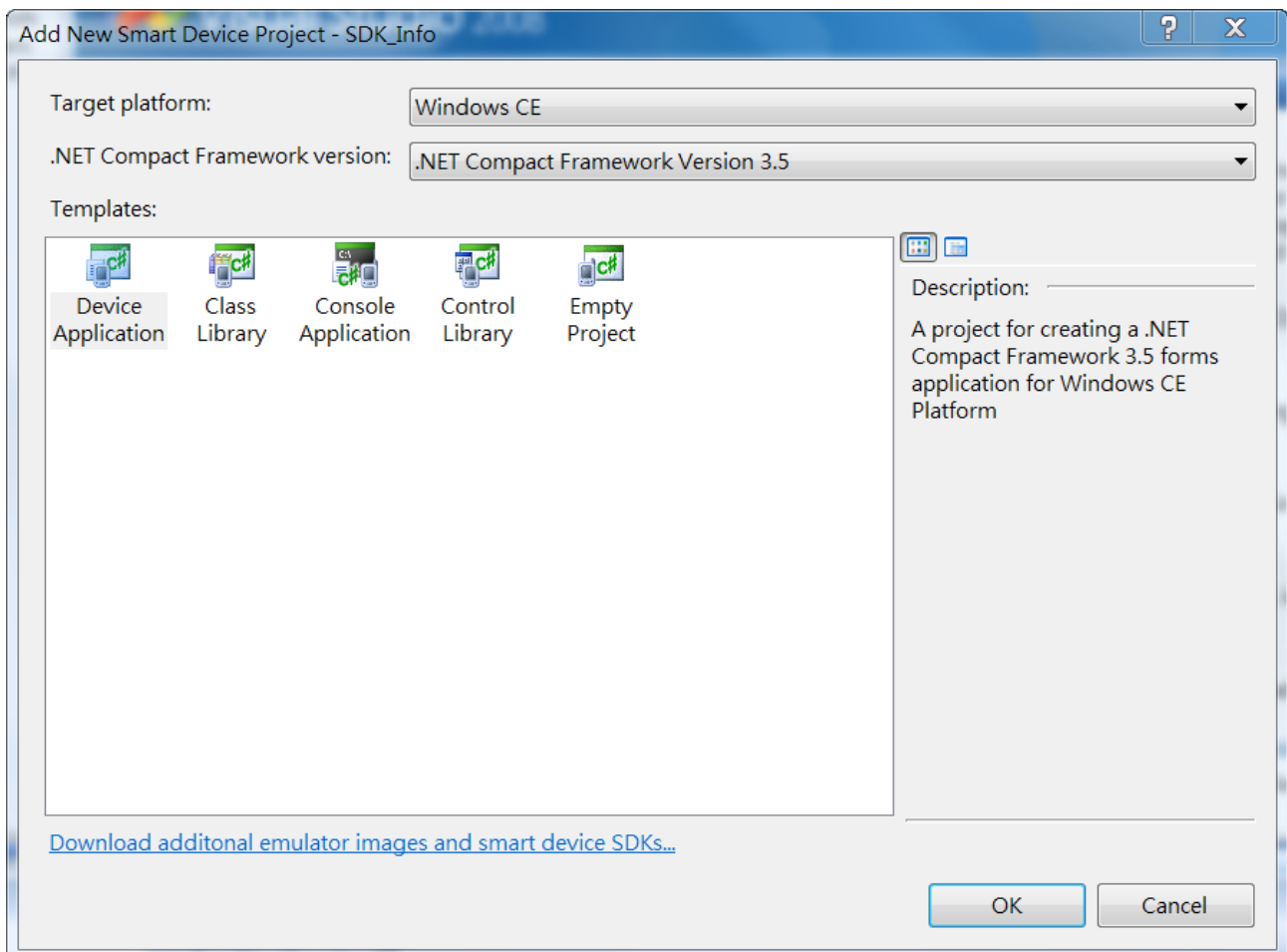

4.3.2. Specify the path of the PAC reference

The PAC SDK provides a complete solution to integrate with WP-8000-CE7 and it's compatible with Visual C#, Visual Basic.NET and C++. In order to use a component in your application, you must first add a reference to it.

Step1: Get the PACNET.dll



The PACNET.dll can be found from the CD that was provided with the package or by downloading the latest version from ICP DAS web site.

CD:\WinPAC_AM335x\WP-8x2x\SDK\PACNET\

http://ftp.icpdas.com/pub/cd/winpac_am335x/wp-8x2x/sdk/pacnet/

Step 2: On the Project menu, and then click Add Reference...

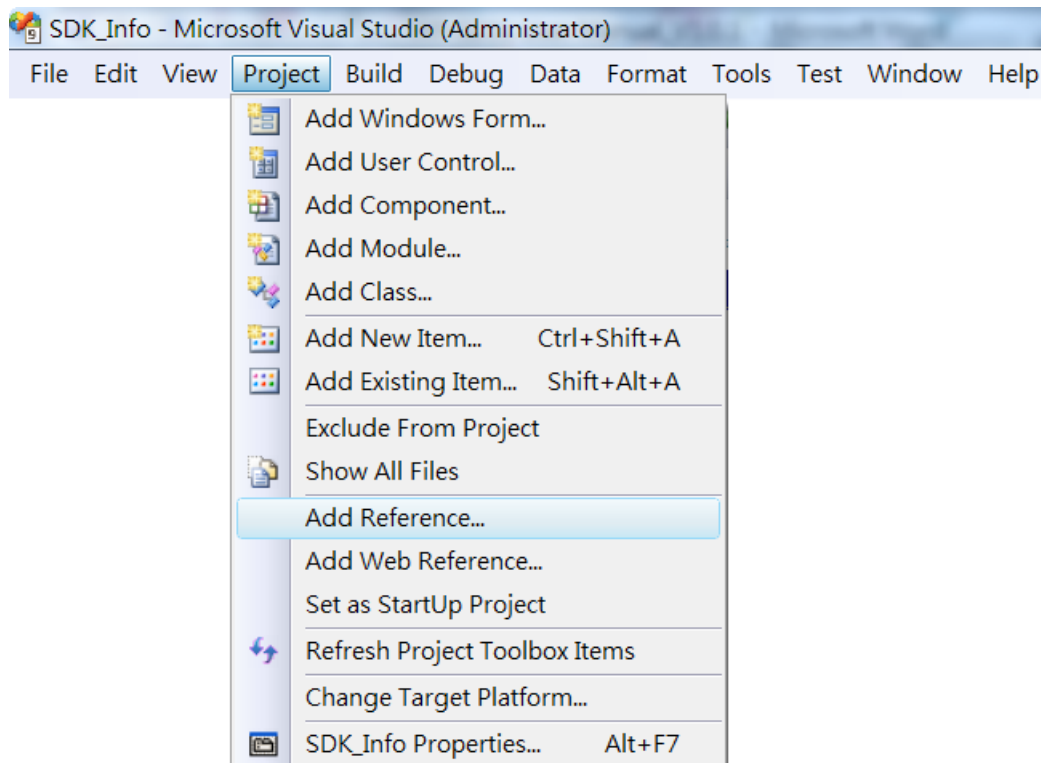

Step 3: On the Browse tab and browse to where the PACNET.dll are installed, and then click OK

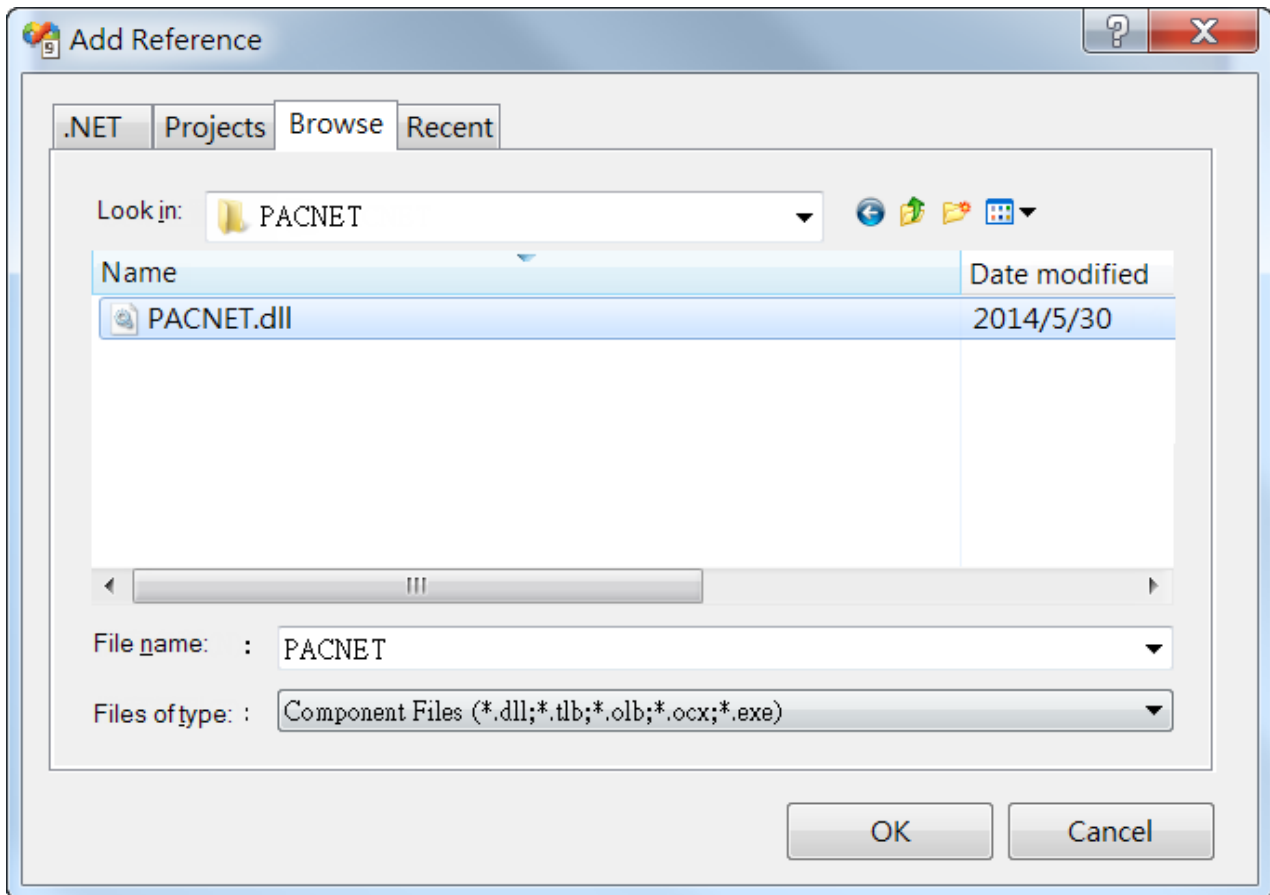

4.3.3. Add the control to the form

You can drag various controls from the Toolbox onto the form. These controls are not really "live"; they are just images that are convenient to move around on the form into a precise location.

After you add a control to your form, you can use the Properties window to set its properties, such as background color and default text. The values that you specify in the Properties window are the initial values that will be assigned to that property when the control is created at run time.

Step 1: On the Toolbox panel, drag a Button control onto the form

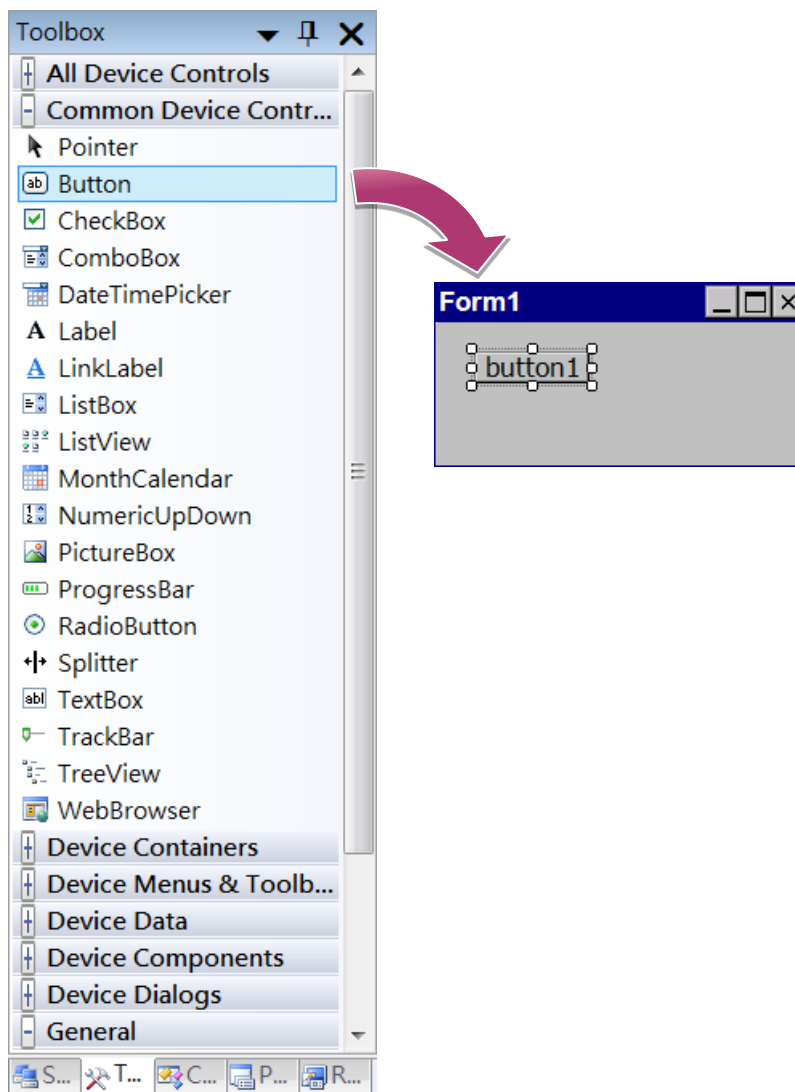

Step 2: On the Properties panel, type Check the SDK version in the Text field

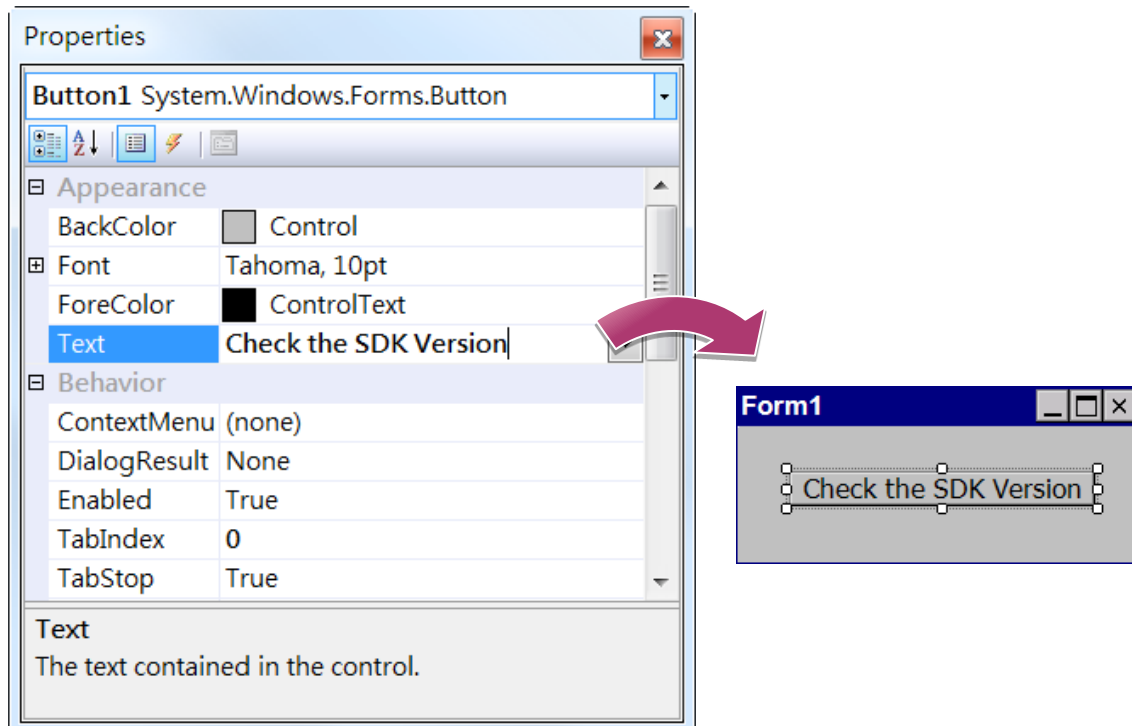

4.3.4. Add the event handling for the control

You have finished the design stage of your application and are at the point when you can start adding some code to provide the program's functionality.

Step 1: Double-click the button on the form

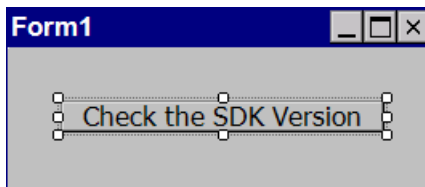

Step 2: Inserting the following code

```
byte[] data = new byte[30];  
PACNET.Sys.GetSDKVersion(data);  
MessageBox.Show(PACNET.MISC.WideString(data));
```

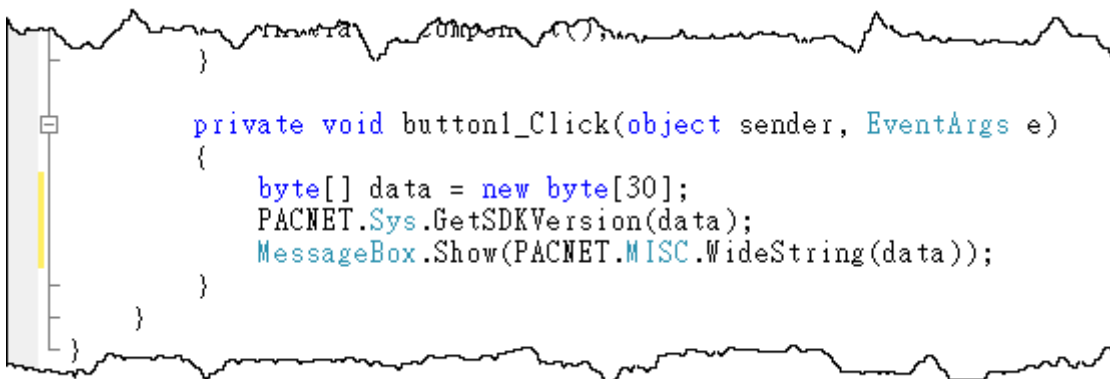

Tips & Warnings



The "PACNET" of "using PACNET" is case-sensitive.

4.3.5. Upload the application to WP-8000-CE7

WP-8000-CE7 supports FTP server service. You can upload files to WP-8000-CE7 or download files from a public FTP server.

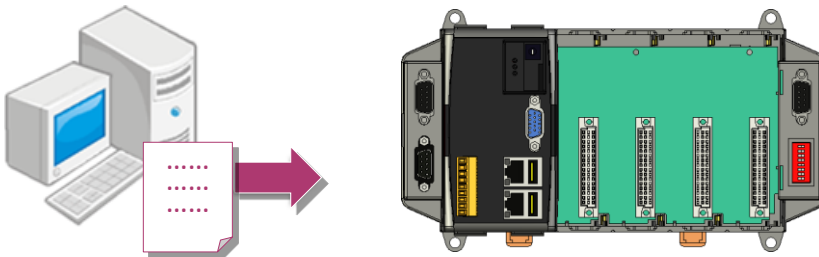

Step 1: On the Build menu, and then click Build [Project Name]

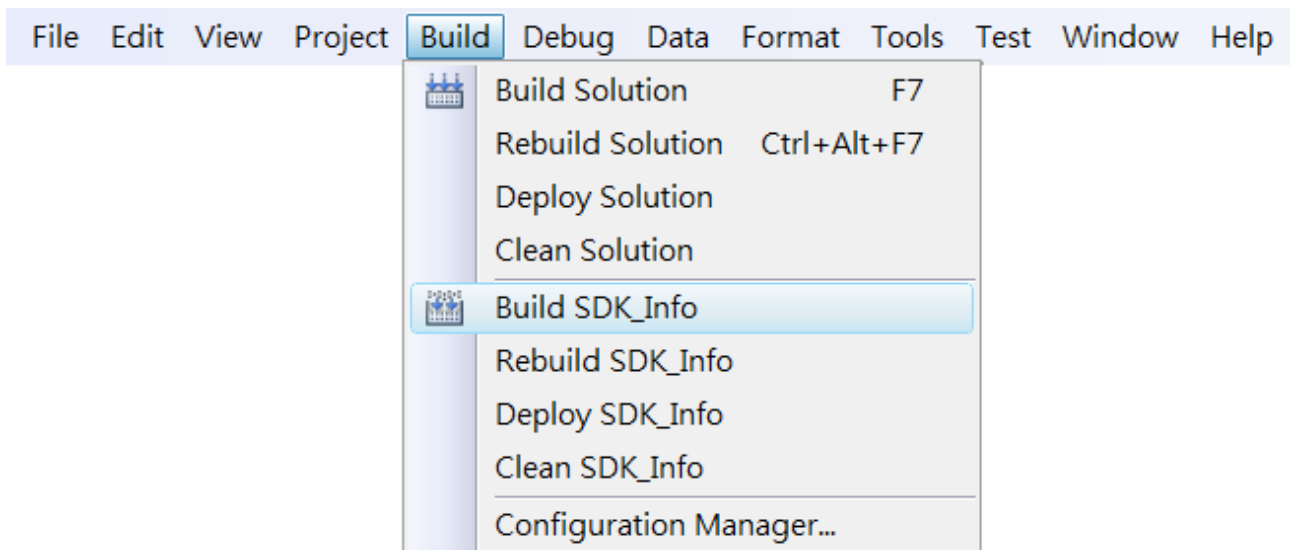

Step 2: Open the browser and type the IP address of WP-8000-CE7

Step 3: Upload the application and the corresponding PACNET.dll files to WP-8000-CE7

Tips & Warnings



For applications programming in C# and VB.net with .net compact framework, when executing these application on WP-8000-CE7, the corresponding PACNET.dll must be in the same directory as the .exe file.

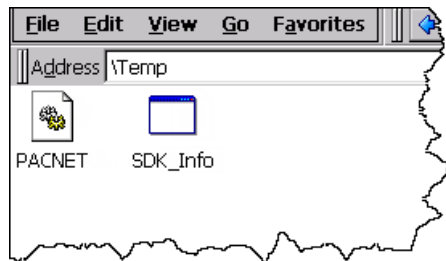

4.3.6. Execute the application on WP-8000-CE7

After uploading the application to WP-8000-CE7, you can just double-click it on WP-8000-CE7 to execute it.

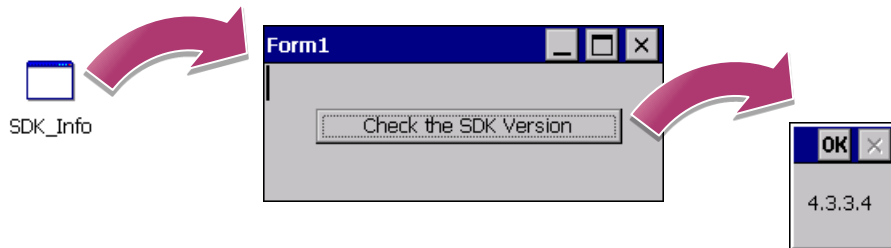

4.4. First WP-8000-CE7 Program in Visual C++

The best way to learn programming with WP-8000-CE7 is to actually create a WP-8000-CE7 program.

The example below demonstrates how to create a demo program running on WP-8000-CE7 with Visual C++.

To create a demo program with Visual C# that includes the following main steps:

1. Create a new project
2. Configure the Platform
3. Include the Header files and Libraries of the PAC SDK
4. Add the control to the form
5. Add the event handling for the control
6. Upload the application to WP-8000-CE7
7. Execute the application on WP-8000-CE7

All main steps will be described in the following subsection.

In this tutorial, we will assume that you have installed WP-8000-CE7 SDK on PC and used the Visual Studio 2008 for application development.

4.4.1. Create a new project

The Visual C# project template is a composite control that you use in this example creates a new project with this user control.

Step 1: Start Visual Studio 2008



Step 2: On the File menu, point to New, and then click Project

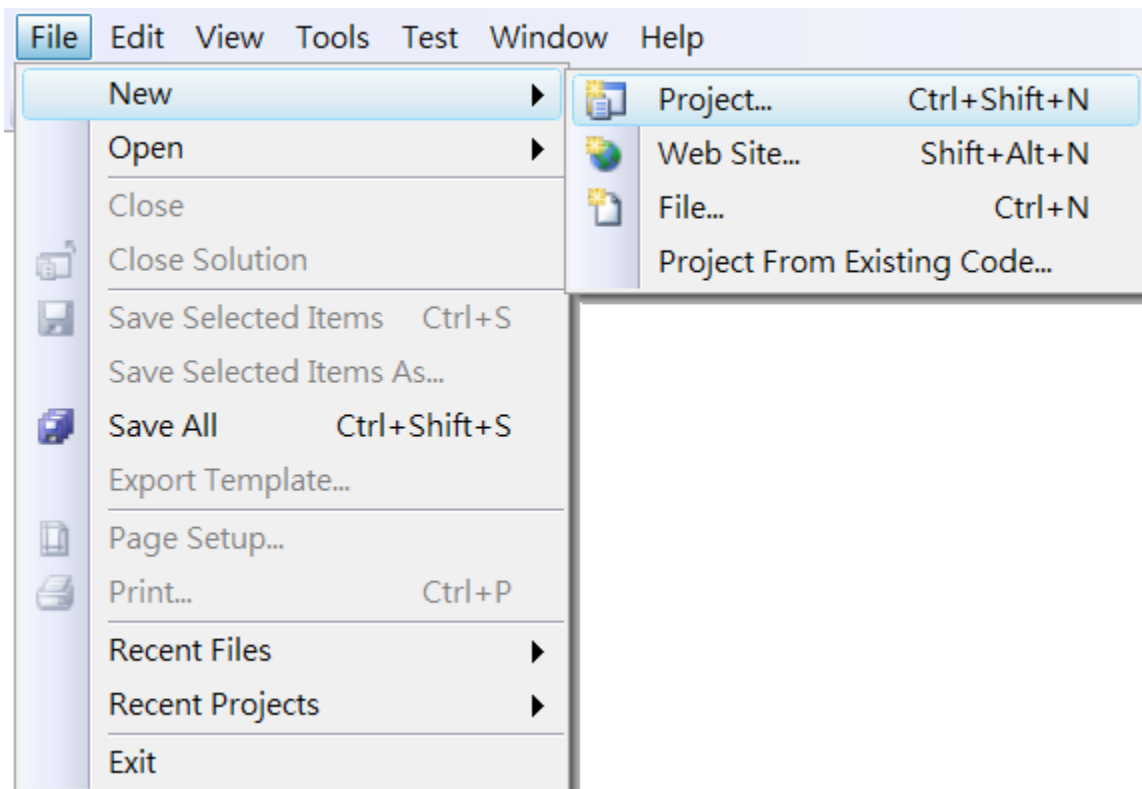

Step 3: In the Project types pane, expand Visual C++ node and select Smart Device

Step 4: In the list of Templates, select MFC Smart Device Application

Step 5: Specify a name and a location for the application and then click OK

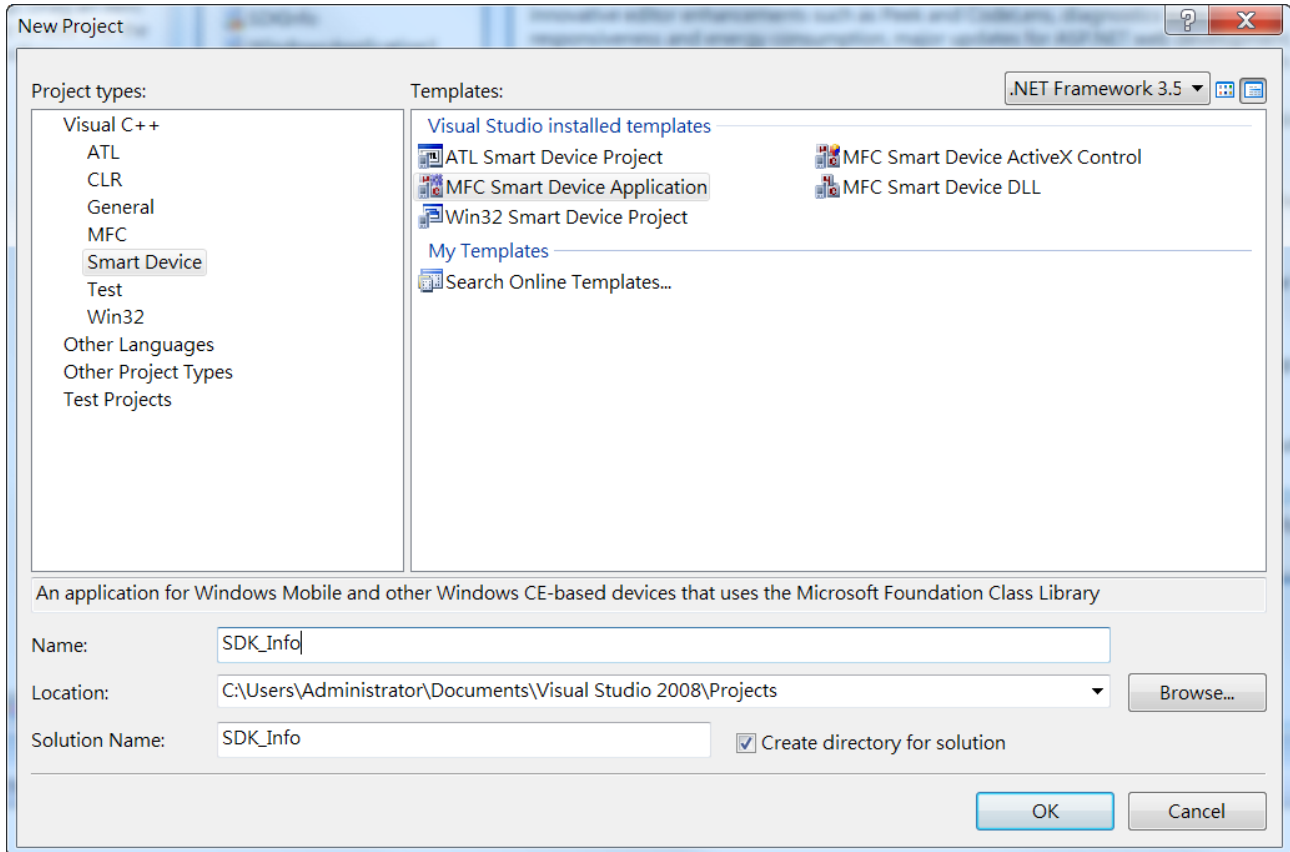

Step 6: On the first page of the wizard, click Next

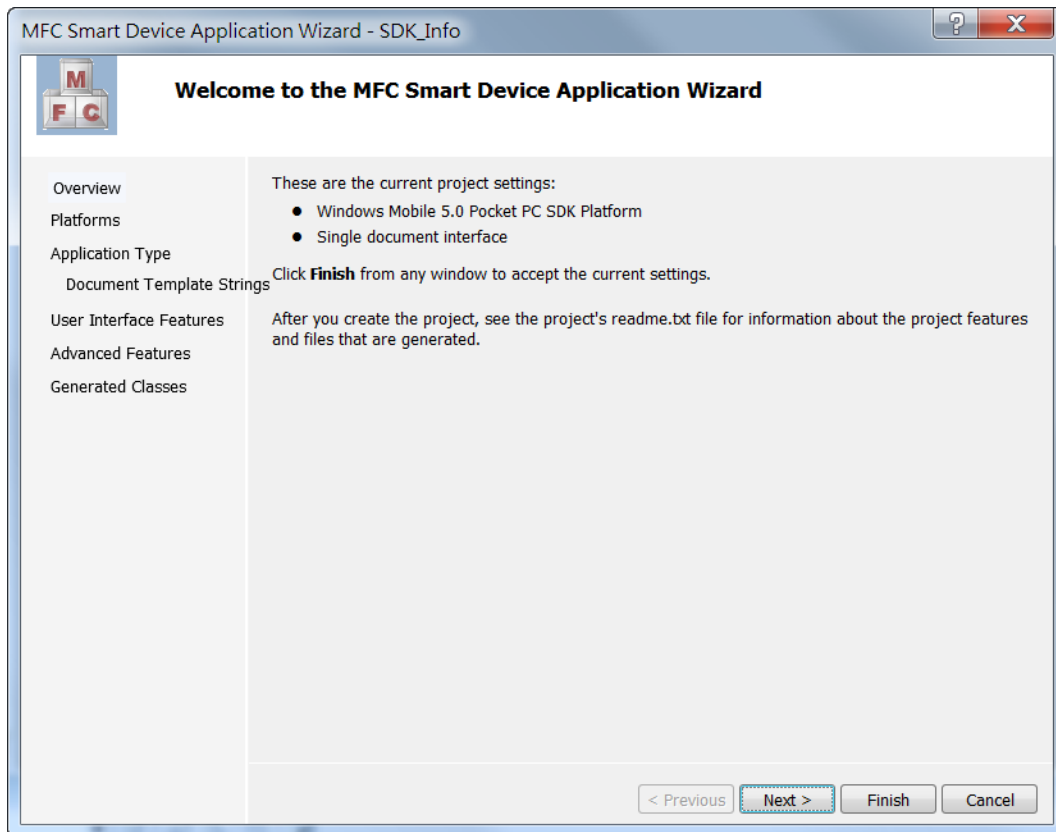

Step 7: On the next page of the wizard, select AM335x_WINCE7_SDK to be added to the project, and then click Next

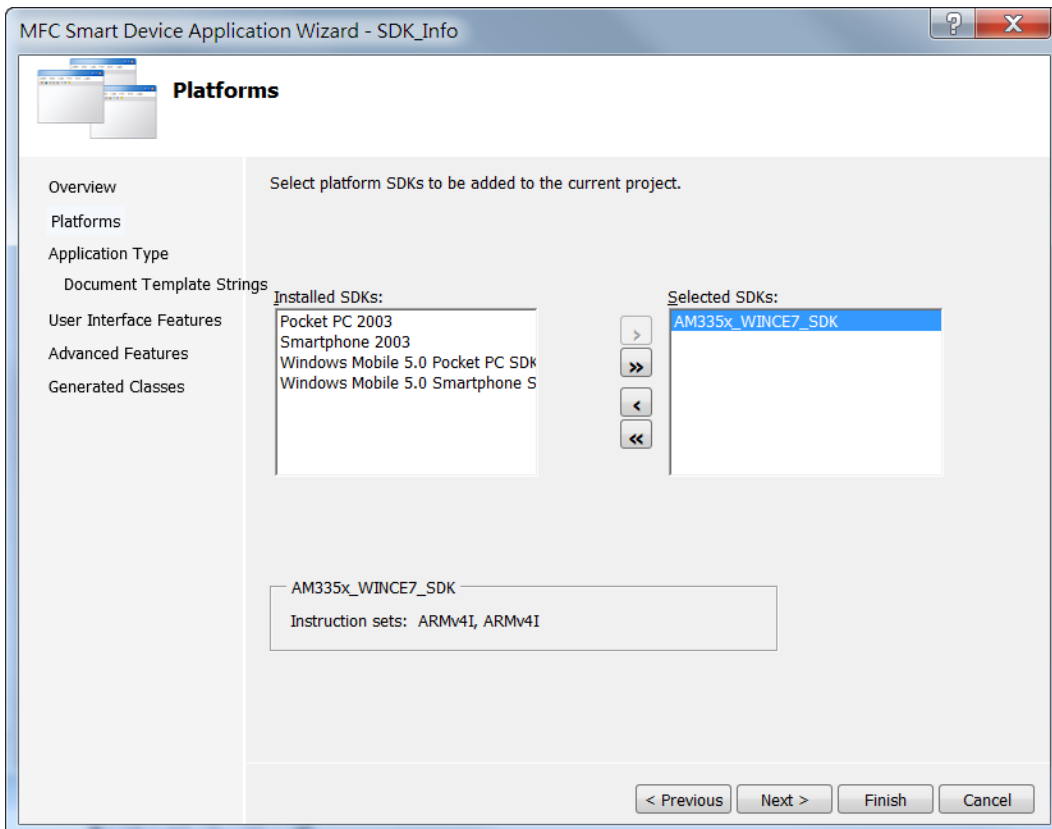

Step 8: On the next page of the wizard, select Dialog based, and then click next

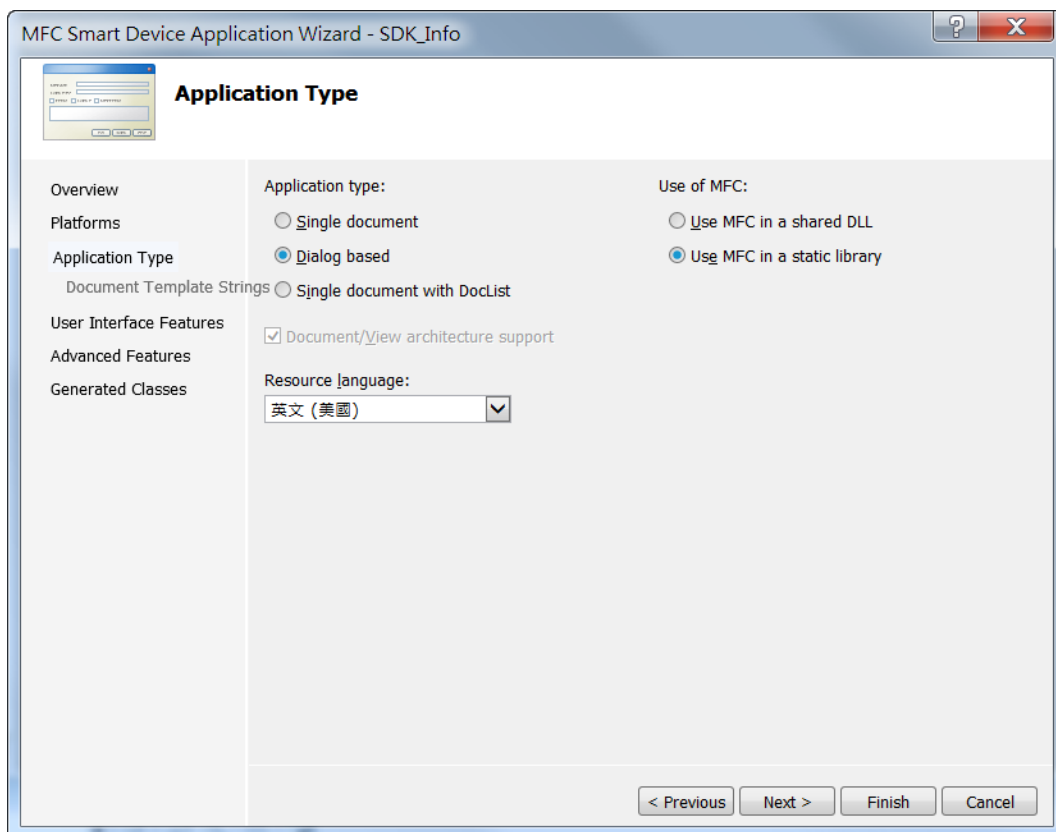

Step 9: On the next page of the wizard, click next

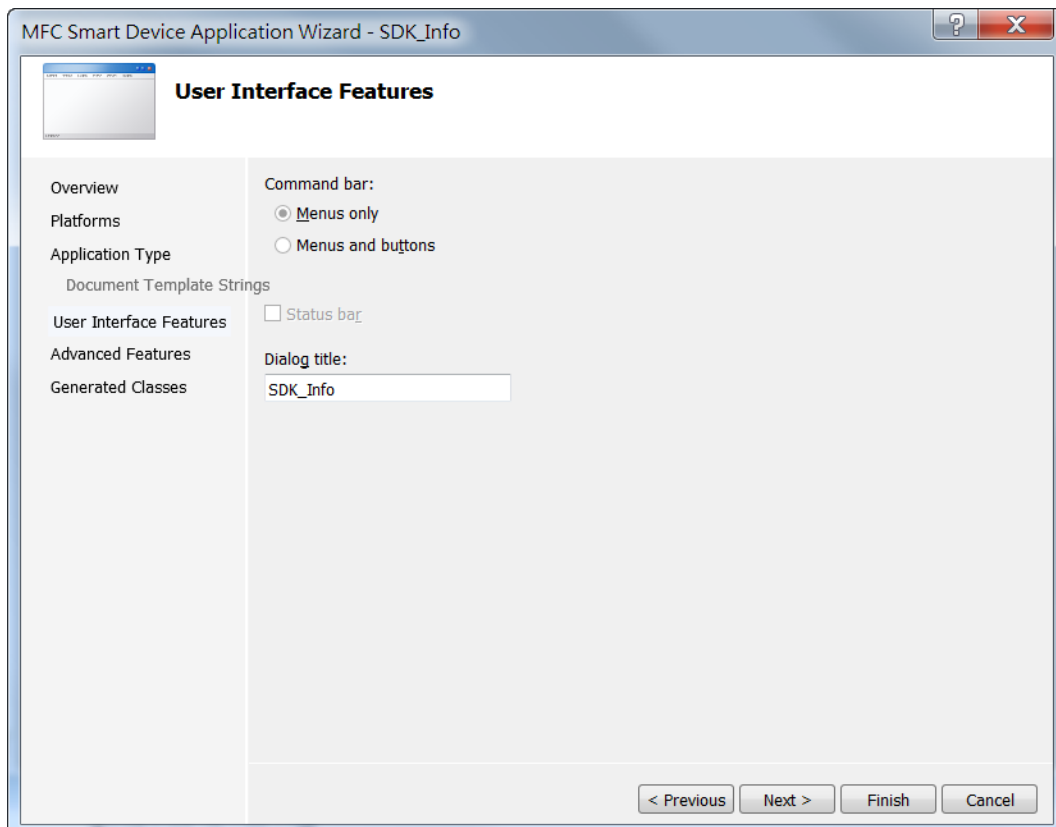

Step 10: On the next page of the wizard, click next

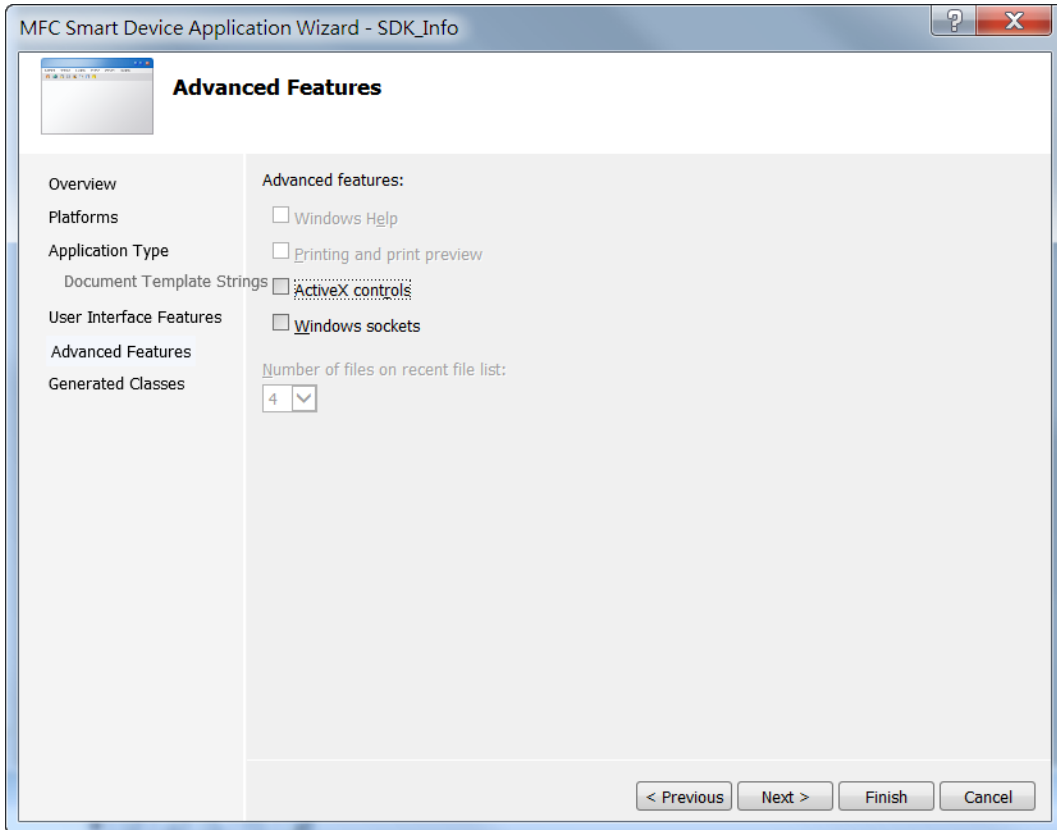

Step 11: On the next page of the wizard, click Finish

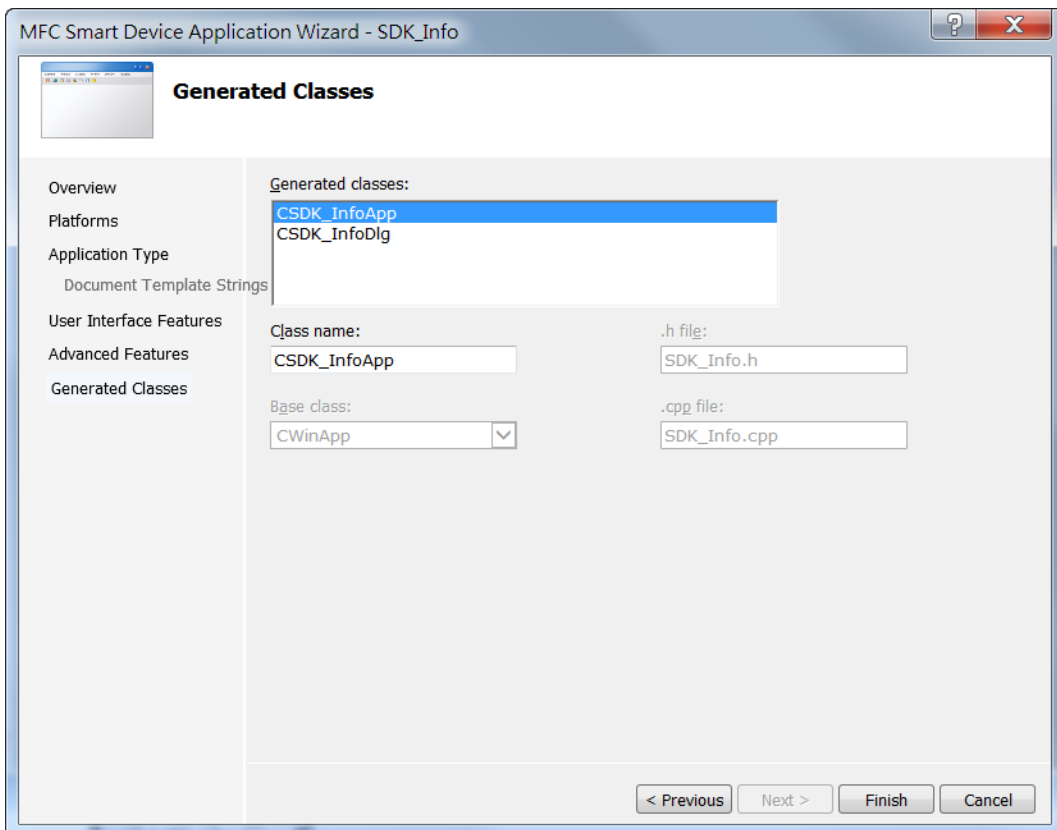

4.4.2. Configure the Platform

When developing applications by using Visual C++, you must configure the Platform to indicate what platform and device you intend to download the application to. Before you deploy your project, check the platform.

On the Debug configuration toolbar, select Release and select AM335x_WINCE7_SDK(ARMv4I) as shown in the following illustration.

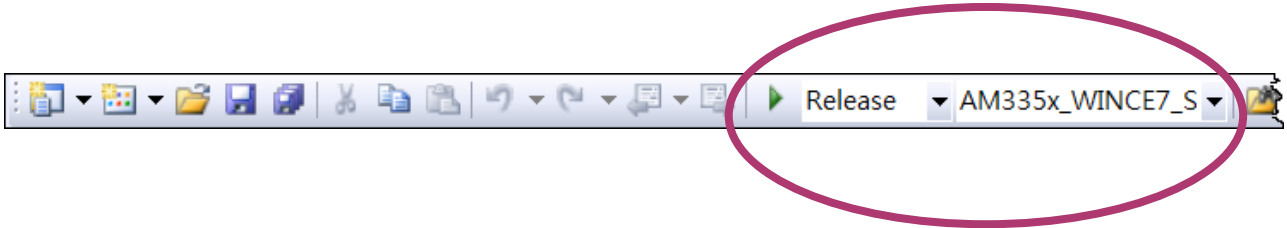

4.4.3. Specify the Libraries of the PAC SDK

The PAC SDK provides the PACSDK libraries with WP-8000-CE7.

It's compatible with C++. In order to use a component in your application, you must first add a reference to it.

Step 1: On the View menu, and then click Property Pages

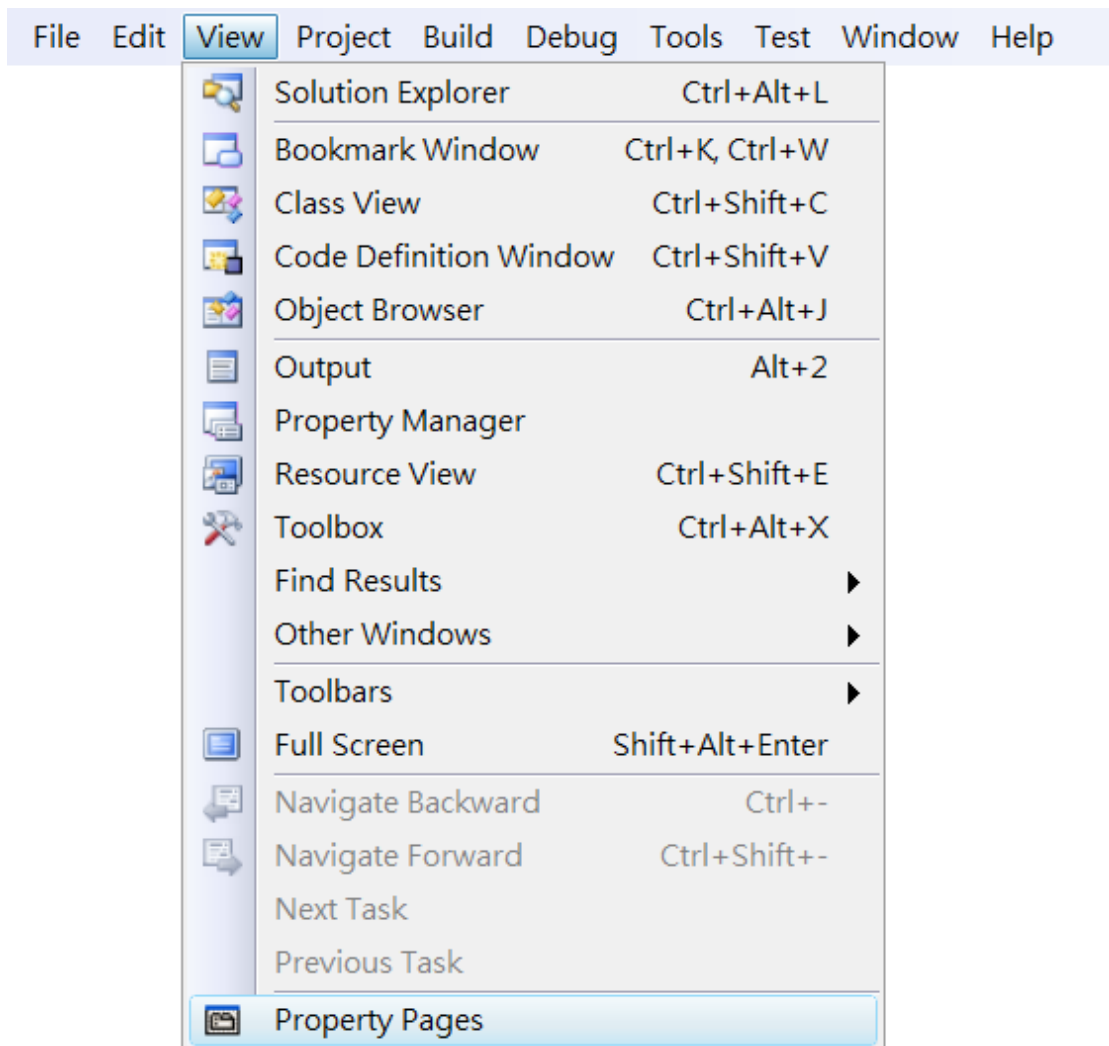

Step 2: In left pane, click Linker, and then click Input

Step 3: In the right pane, Type PACSDK.lib in the Additional Dependencies item

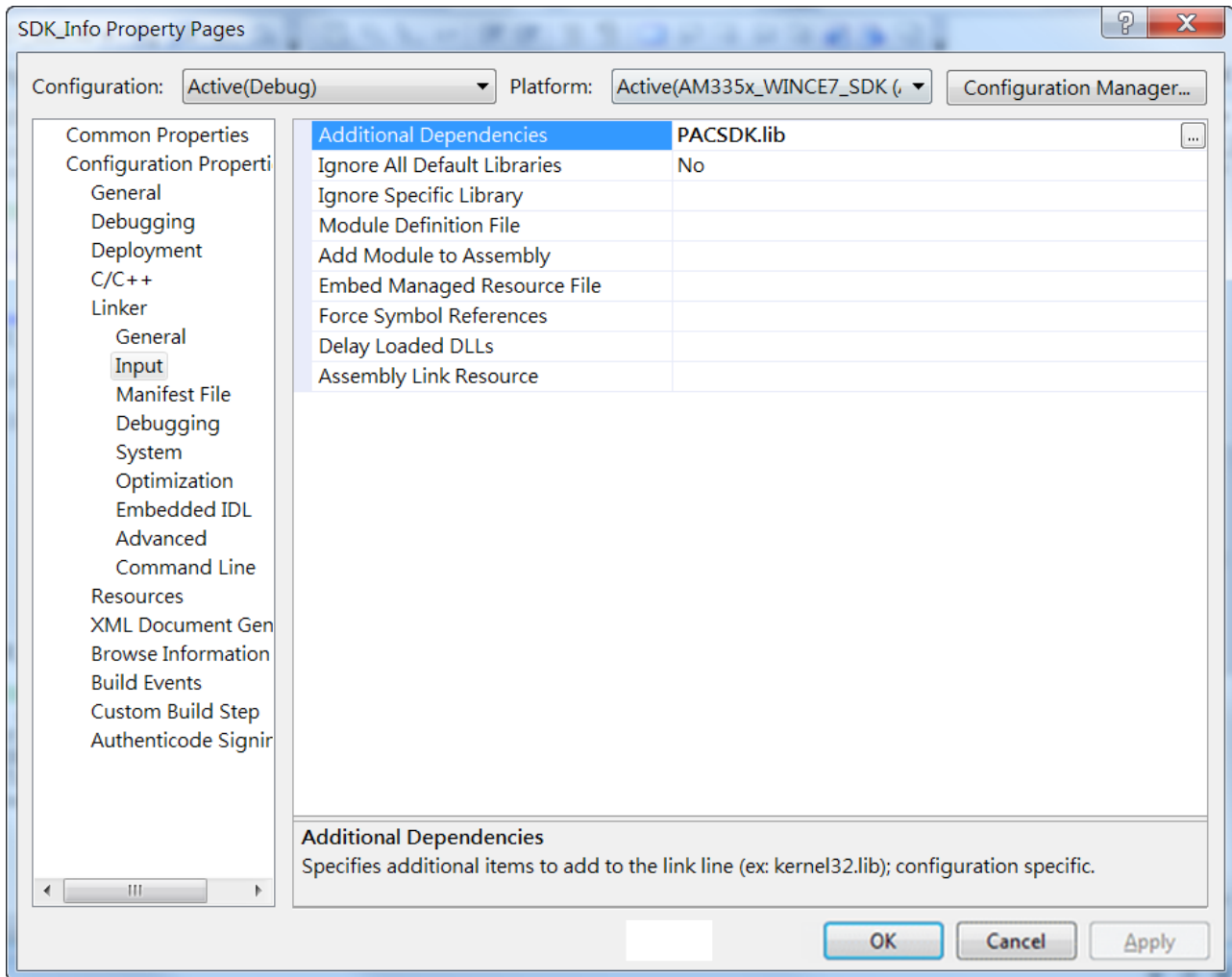

4.4.4. Add the control to the form

You can drag various controls from the Toolbox onto the form. These controls are not really "live"; they are just images that are convenient to move around on the form into a precise location.

After you add a control to your form, you can use the Properties window to set its properties, such as background color and default text. The values that you specify in the Properties window are the initial values that will be assigned to that property when the control is created at run time.

Step 1: On the View menu, and then click Resource View

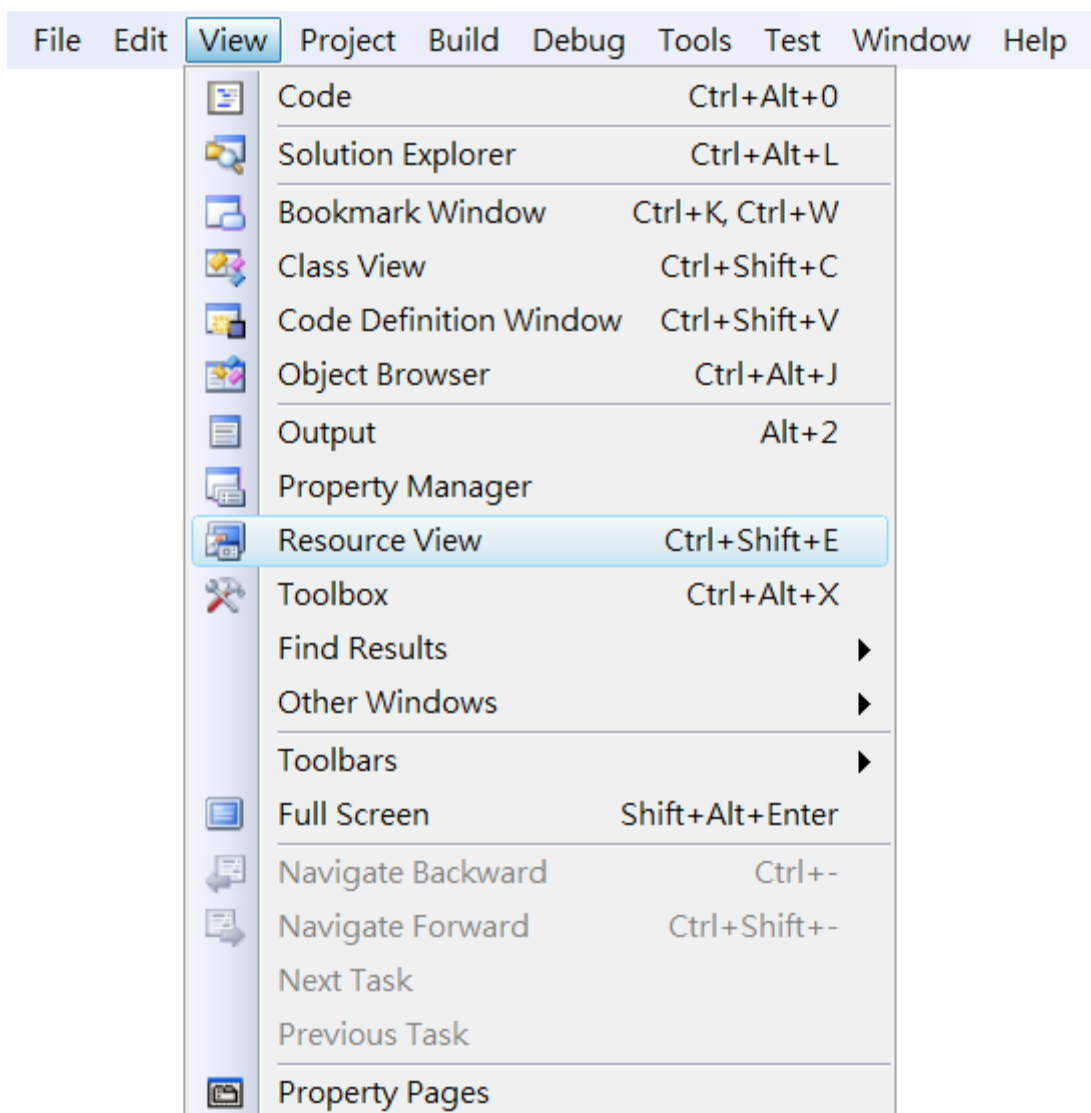

Step 2: In the Resource View Panel, Expand the [Project name].rc file and then expand the Dialog item to click the plug-in dialog

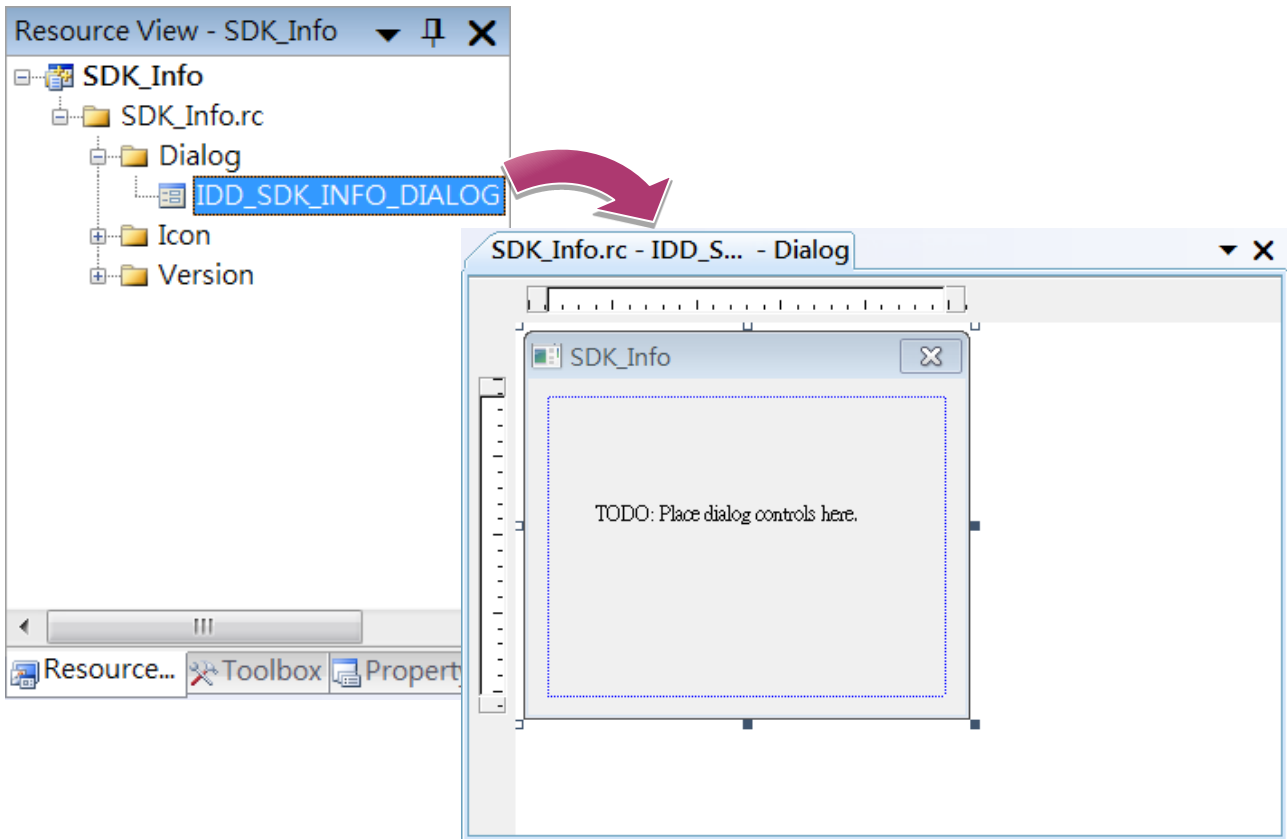

Step 3: On the Toolbox panel, drag a Button control onto the form

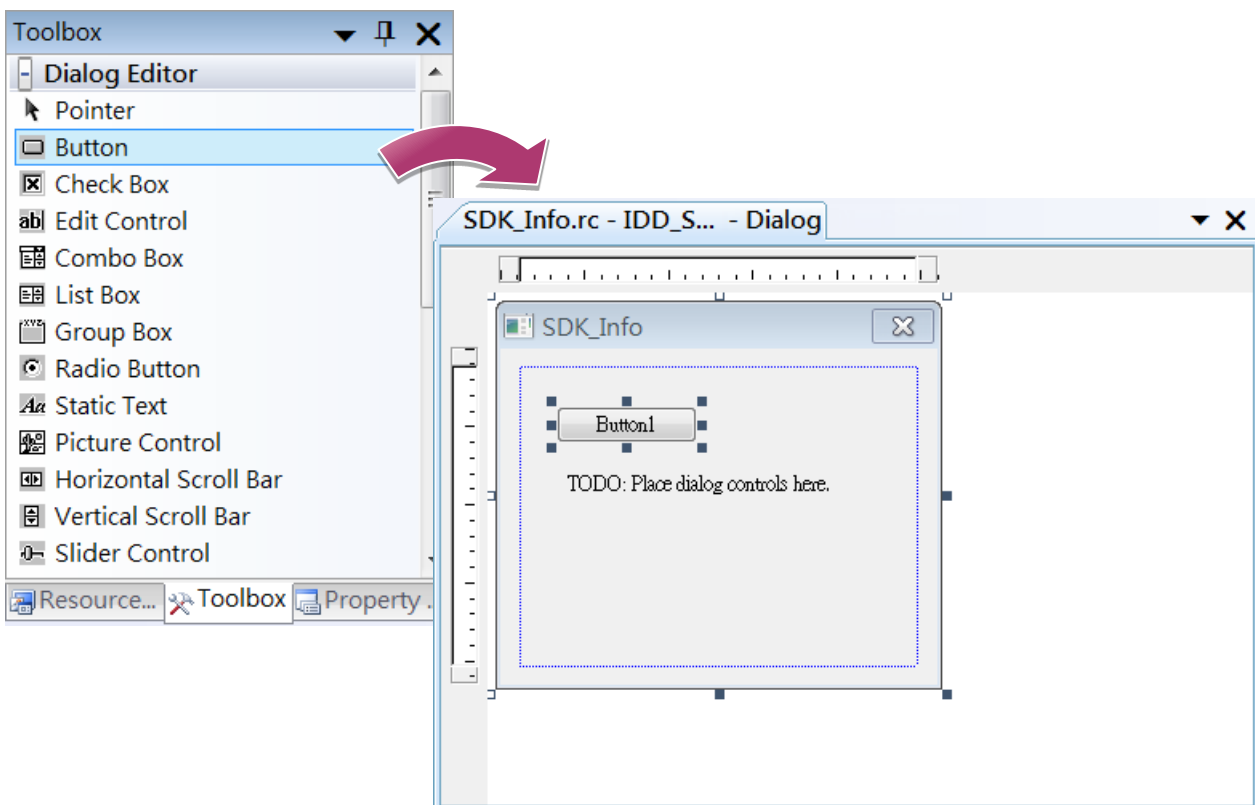

Step 4: On the Properties panel, type Check the SDK version in the Caption field

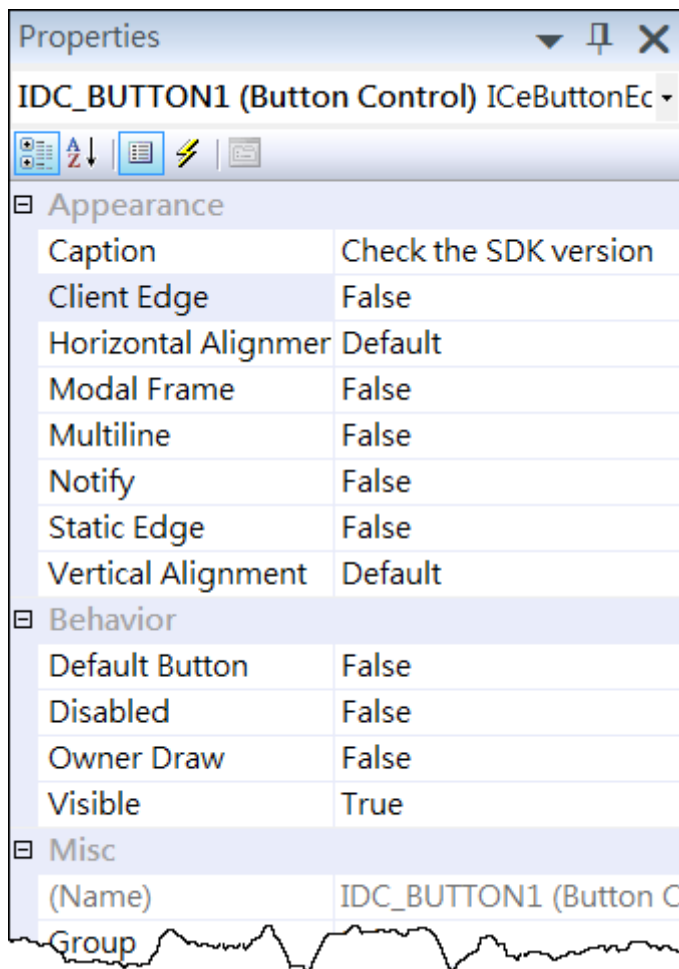

4.4.5. Add the event handling for the control

You have finished the design stage of your application and are at the point when you can start adding some code to provide the program's functionality.

Step 1: Double-click the button on the form

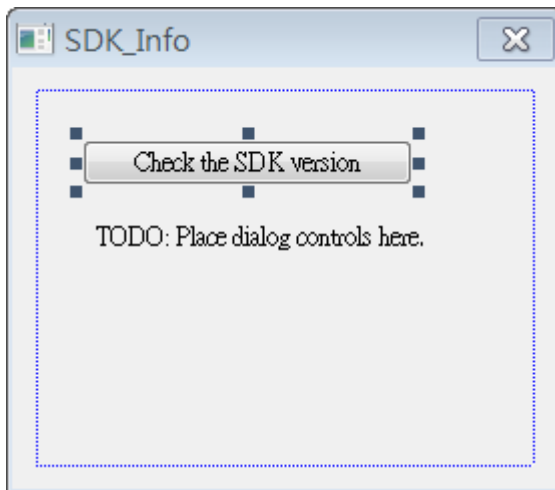

Step 2: Inserting the following code

```
char sdk_version[32];  
TCHAR buf[32];  
pac_GetSDKVersion(sdk_version);  
pac_AnsiToWideString(sdk_version, buf);  
MessageBox(buf,0,MB_OK);
```



Step 2: Inserting the following code into the header area

```
#include "PACSDK.h"
```

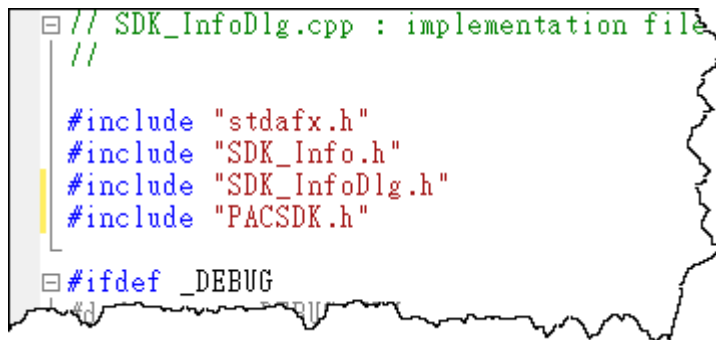

```
// SDK_InfoDlg.cpp : implementation file
//
#include "stdafx.h"
#include "SDK_Info.h"
#include "SDK_InfoDlg.h"
#include "PACSDK.h"
#ifdef _DEBUG
```

4.4.6. Upload the application to WP-8000-CE7

WP-8000-CE7 supports FTP server service. You can upload files to WP-8000-CE7 or download files from a public FTP server.

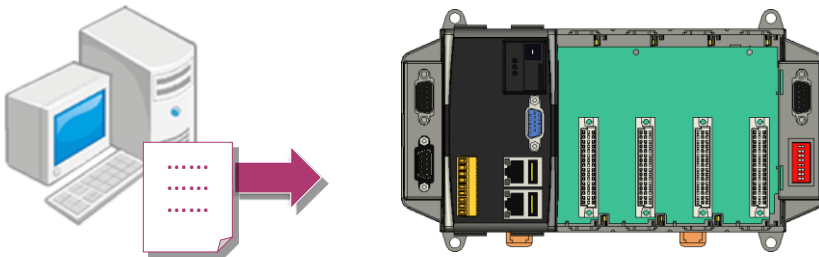

Step 1: On the Build menu, and then click Build [Project Name]

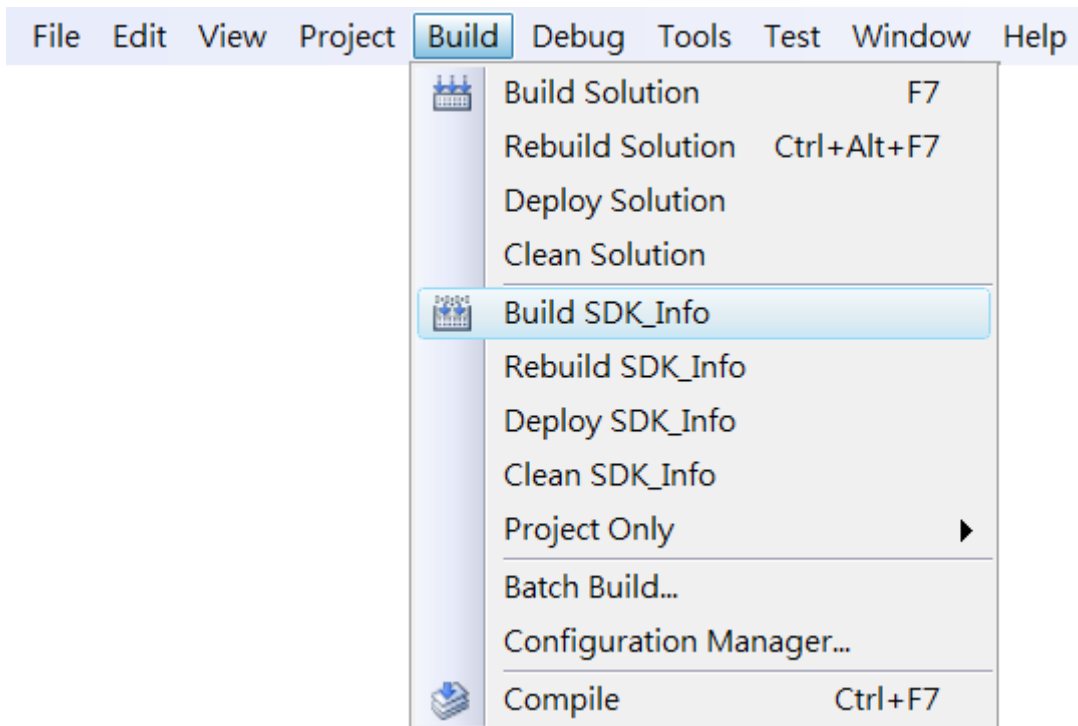

Step 2: Open the browser and type the IP address of WP-8000-CE7

Step 3: Upload the application to WP-8000-CE7

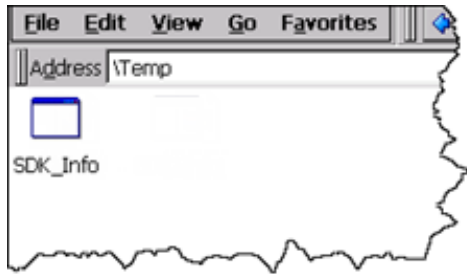

4.4.7. Execute the application on WP-8000-CE7

After uploading the application to WP-8000-CE7, you can just double-click it on WP-8000-CE7 to execute it.

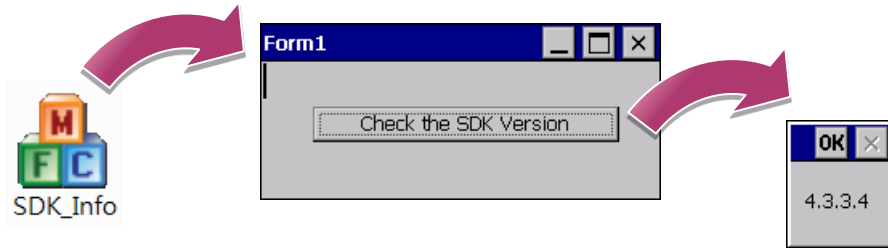

5. I/O Expansion Modules and SDKs Selection

This chapter describes how to select a suitable expansion I/O module and the corresponding SDK library to be used for developing programs on WP-8000-CE7.

WP-8000-CE7 provides the following I/O expansion buses:

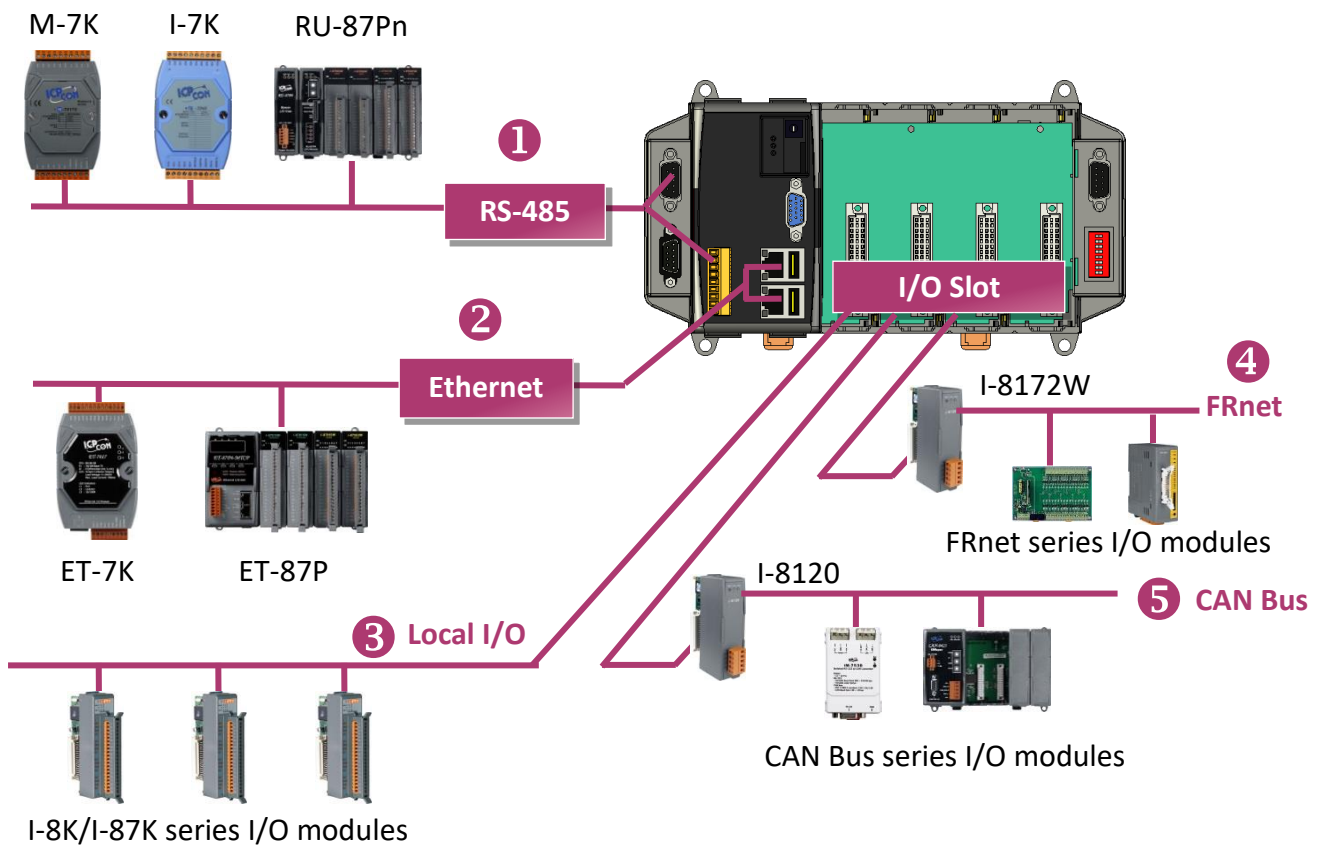

1. RS-485

I-7000, M-7000, RU-87Pn and high profile I-87K series modules connect to WP-8000-CE7 via a twisted-pair, multi-drop, 2-wire RS-485 network.

➤ I-7000 series I/O module

Module	Native SDK	.NET CF SDK
I-7000 series	PACSDK.dll	PACNET.dll
I-7000 series with I-7088 (D)	PACSDK_PWM.dll	PACNET.dll

For full details regarding I-7000 series I/O modules and its demos, please refer to:

http://ftp.icpdas.com/pub/cd/winpac_am335x/wp-8x2x/pac/applicable_demo_for_7k_module.pdf

➤ M-7000 series I/O module

Module	Native SDK	.NET CF SDK
M-7000 series	Modbus Demo	Modbus Demo

For more detailed information about M-7000 series modules using Modbus protocol and its demos, please refer to:

CD:\WinPAC_AM335x\Wp-8x2x\demo\nModbus\

➤ RU-87Pn + I-87K series I/O module

Module	Native SDK	.NET CF SDK
RU-87Pn+I-87K series	PACSDK.dll	PACNET.dll

➤ Other Specified I/O

Module	Native SDK	.NET CF SDK
Others	PACSDK.dll	PACNET.dll

2. Ethernet

The Ethernet I/O devices available include ET-7000 and I-8KE4/8-MTCP, and support either the DCON or the Modbus/TCP communication protocol.

Module	Native SDK	.NET CF SDK
M-7000 series	Modbus Demo	Modbus Demo
I-8KE4/8-MTCP	Modbus Demo	Modbus Demo

For more detailed information about ET-7000 and I-8KE4/8-MTCP series modules using Modbus protocol and its demos, please refer to:

http://ftp.icpdas.com/pub/cd/winpac_am335x/wp-8x2x/demo/nmodbus/

3. Local I/O

WP-8000-CE7 has 1/4/8 expansion slots that can be used to add expansion I/O modules. The expansion I/O modules can be divided into two categories: High Profile I-8K series I/O modules and High profile I-87K series I/O modules. The following indicates the appropriate SDK library to be used for I/O modules.

➤ General I-8K/I-87K series I/O module

Module	Native SDK	.NET CF SDK
I-8K series	PACSDK.dll	PACNET.dll
I-87K series	PACSDK.dll	PACNET.dll
I-8K series with PWM	PACSDK_PWM.dll	PACNET.dll
I-87K series with PWM	PACSDK_PWM.dll	PACNET.dll

For full details regarding I-87K series I/O modules and its demos, please refer to:

http://ftp.icpdas.com/pub/cd/winpac_am335x/wp-8x2x/pac/applicable_demo_for_87k_module.pdf

➤ Other Specified I/O

Module	Native SDK	.NET CF SDK
I-8014W	pac_i8014W.dll	pac_i8014WNET.dll
I-8017HW	pac_i8017HW.dll	pac_i8017HWNET.dll
I-8024W	pac_i8024W.dll	pac_i8024WNET.dll
I-8026W	pac_i8026W.dll	pac_i8026WNET.dll
I-8048W	pac_i8048W.dll	pac_i8048WNET.dll
I-8050W	pac_i8050W.dll	pac_i8050WNET.dll
I-8084W	pac_i8084W.dll	pac_i8084WNET.dll
I-8088W	pac_i8088W.dll	pac_i8088WNET.dll
I-8093W	pac_i8093W.dll	pac_i8093WNET.dll
I-87088W	PACSDK_PWM.dll	PACNET.dll

4. FRnet

FRnet is an innovative industrial field bus technology that uses twisted pair cable as the transmission medium. The status of all I/O devices is updated on a fixed cycle, no matter how many FRnet I/O modules are connected to the FRnet network.

Module	Native SDK	.NET CF SDK
I-8172W	pac_i8172W.lib	pac8172WNet.dll

5. CAN Bus

The Controller Area Network (CAN) is a serial communication way, which efficiently supports distributed real-time control with a very high level of security. It provides the error-processing mechanisms and concepts of message priority. These features can improve the network reliability and transmission efficiency.

Module	Native SDK	.NET CF SDK
I-8120W	i8120.lib	i8120net_pac.dll

6. API Resources and Demo References

This chapter provides a brief overview of PAC standard APIs and demos that have been designed for WP-8000-CE7 from the PAC SDK package.

ICP DAS provides a set of demos in different programming languages. You can examine the demo codes, which includes numerous comments, to familiarize yourself with the PAC APIs. This will allow developing your own applications quickly by modifying these demo programs.

For full usage information regarding the description, prototype and the arguments of the functions, please refer to the “PAC Standard API Manual”

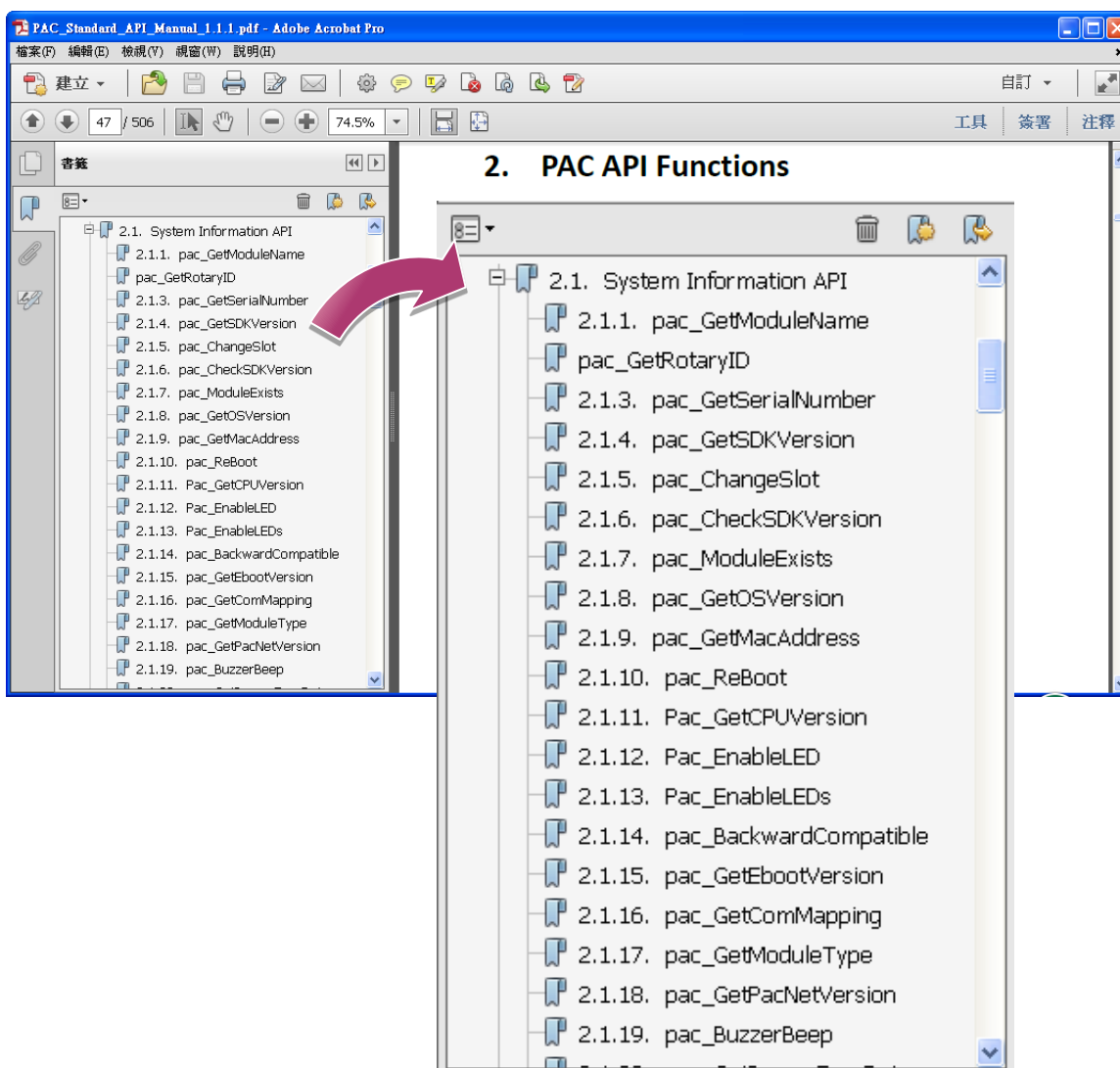

6.1. PAC Standard APIs for System Operation

The diagram below shows the set of each system operation API provided in the PACSDK.

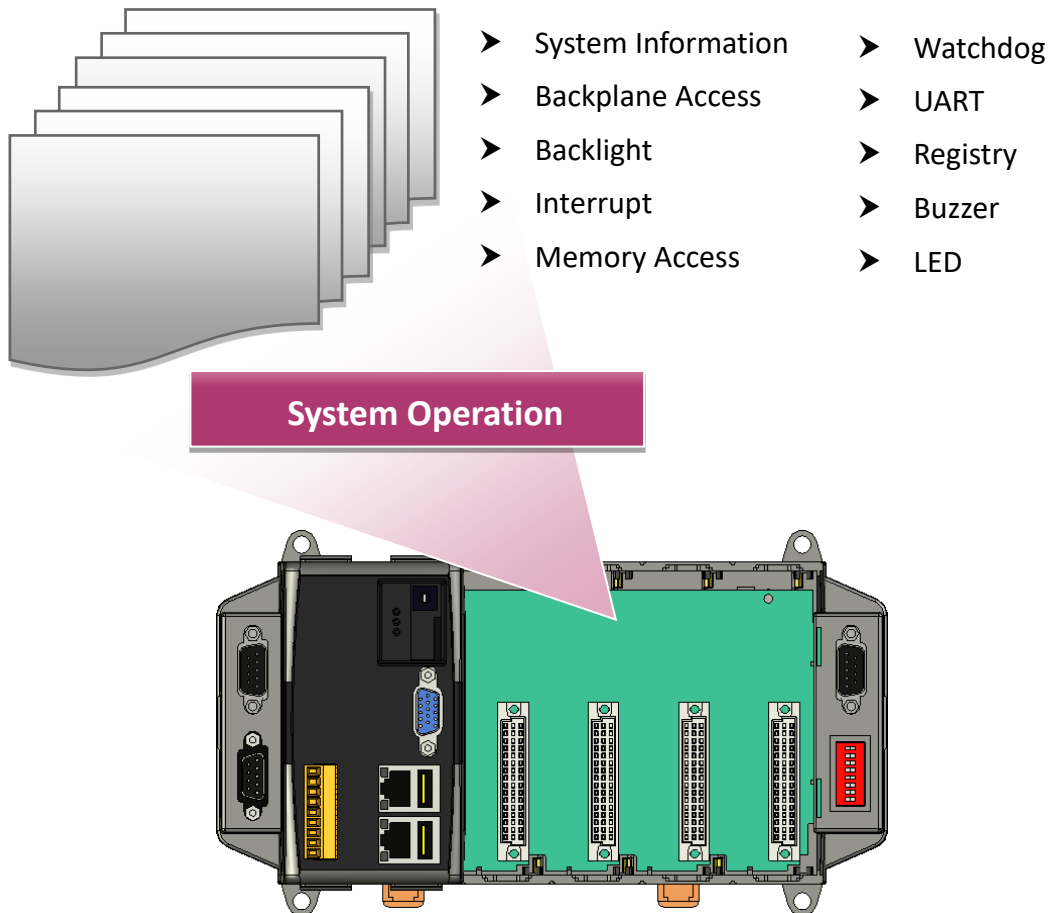

6.1.1. VB.NET Demos for PAC Standard APIs

The PAC SDK includes the following demos that demonstrate the use of the PAC Standard APIs in a VB.NET language environment.

The following demos can be found on the CD that was provided with the package or by downloading the latest version from ICP DAS web site.

CD:\WinPAC_AM335x\wp-8x2x\demo\PAC\Vb.net\Standard\

http://ftp.icpdas.com/pub/cd/winpac_am335x/wp-8x2x/demo/pac/vb.net/standard/

Folder	Demo	Explanation
buzzer	buzzer	Shows how to make a simple buzzer beep.
DeviceInformation	DeviceInformation	Retrieves information about the OS version, CPU version, SDK version, etc.
GetRotaryID	GetRotaryID	Retrieves information about the status of the rotary switch
Memory	Memory	Shows how to read/write data values from/to the EEPROM or the backplane of the SRAM
MicroSD	MicroSD	Shows how to manage the microSD
RealTimeTest	RealTimeTest	Writes the managed code for the rich graphical user interface that does not require true real-time performance
Registry	Registry	Shows how to read/write data values from/to the registry
UART	UART	Shows how to read the name of a local I/O modules via a UART
WatchDog	WatchDog	Displays information about how to operate the watchdog

6.1.2. C# Demos for PAC Standard APIs

The PAC SDK includes the following demos that demonstrate the use of the PAC Standard APIs in a C# language environment.

The following demos can be found on the CD that was provided with the package or by downloading the latest version from ICP DAS web site.

CD:\WinPAC_AM335x\wp-8x2x\demo\PAC\C#\Standard\

http://ftp.icpdas.com/pub/cd/winpac_am335x/wp-8x2x/demo/pac/c%23/standard/

Folder	Demo	Explanation
buzzer	buzzer	Shows how to make a simple buzzer beep.
DeviceInformation	DeviceInformation	Retrieves information about the OS version, CPU version, SDK version, etc.
GetRotaryID	GetRotaryID	Retrieves information about the status of the rotary switch
Memory	Memory	Shows how to read/write data values from/to the EEPROM or the backplane of the SRAM
MicroSD	MicroSD	Shows how to manage the microSD
RealTimeTest	RealTimeTest	Writes the managed code for the rich graphical user interface that does not require true real-time performance
Registry	Registry	Shows how to read/write data values from/to the registry
UART	UART	Shows how to read the name of a local I/O modules via a UART
WatchDog	WatchDog	Displays information about how to operate the watchdog

6.1.3. Visual C++ Demos for PAC Standard APIs

The PAC SDK includes the following demos that demonstrate the use of the PAC Standard APIs in a Visual C++ language environment.

The following demos can be found on the CD that was provided with the package or by downloading the latest version from ICP DAS web site.

CD:\WinPAC_AM335x\wp-8x2x\demo\PAC\Vc2008\Standard\

http://ftp.icpdas.com/pub/cd/winpac_am335x/wp-8x2x/demo/pac/vc2008/standard/

Folder	Demo	Explanation
buzzer	buzzer	Shows how to make a simple buzzer beep.
DeviceInformation	DeviceInformation	Retrieves information about the OS version, CPU version, SDK version, etc.
GetRotaryID	GetRotaryID	Retrieves information about the status of the rotary switch
Memory	Memory	Shows how to read/write data values from/to the EEPROM or the backplane of the SRAM
MicroSD	MicroSD	Shows how to manage the microSD
RealTimeTest	RealTimeTest	Writes the managed code for the rich graphical user interface that does not require true real-time performance
Registry	Registry	Shows how to read/write data values from/to the registry
UART	UART	Shows how to read the name of a local I/O modules via a UART
WatchDog	WatchDog	Displays information about how to operate the watchdog

6.2. PAC Standard APIs for PAC Expansion I/O

The diagram below shows the types of the PAC IO APIs provided in the PACSDK.

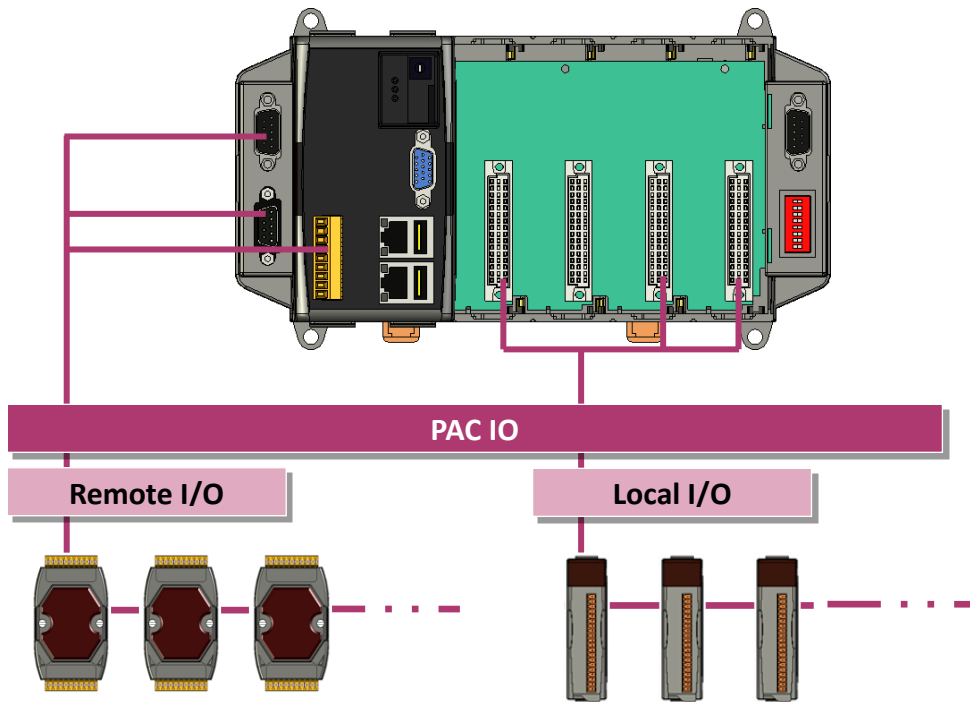

6.2.1. VB.NET Demos for PAC Expansion I/O

The PAC SDK includes the following demos that demonstrate the use of the PAC expansion I/O in a VB.NET language environment.

The following demos can be found on the CD that was provided with the package or by downloading the latest version from ICP DAS web site.

CD:\WinPAC_AM335x\wp-8x2x\Demo\PAC\Vb.net\IO\

http://ftp.icpdas.com/pub/cd/winpac_am335x/wp-8x2x/demo/pac/vb.net/io/

Folder	Demo	Explanation
Local	find_io	Shows how to retrieve the module names and types which plugged in the WinPAC.
	8k_di	Shows how to read the DI values of DI module. This demo program is used by 8K series DI modules.
	8k_do	Shows how to write the DO values to DO module. This demo program is used by 8K series DO modules.
	8k_dio	Shows how to read the DI and the DO values of the DIO module. This demo program is used by 8K series DIO modules.
	87k_basic	Shows how to send/receive a command/response application. This demo program is used by 87K series modules.
	87K_demo	Shows how use uart API and the IO modules located as slots. This demo program is used by 87K series modules.
	87k_ai	Shows how to read the AI values of AI module. This demo program is used by 87K series AI modules.
	87k_ao	Shows how to write the AO values to AO module. This demo program is used by 87K series AO modules.
	87k_di	Shows how to read the DI values of DI module. This demo program is used by 87K series DI modules.
	87k_do	Shows how to write the DO values to DO module. This demo program is used by 87K series DO modules.
	87k_dio	Shows how to read the DI and the DO values of the DIO module. This demo program is used by 87K series DIO modules.
Remote	7k87k_basic	Shows how to send/receive a command/response application. This demo program is used by 7K or 87K series AI modules which connected through a COM port.

Folder	Demo	Explanation
Remote	7k87k_ai	Shows how to read the AI values of AI module. This demo program is used by 7K or 87K series AI modules which connected through a COM port.
	7k87k_ao	Shows how to write the AO values to AO module. This demo program is used by 7K or 87K series AI modules which connected through a COM port.
	7k87k_di	Shows how to read the DI values of DI module. This demo program is used by 7K or 87K series AI modules which connected through a COM port.
	7k87k_do	Shows how to write the DO values to DO module. This demo program is used by 7K or 87K series AI modules which connected through a COM port.
	7k87k_dio	Shows how to read the DI and the DO values of the DIO module. This demo program is used by 7K or 87K series AI modules which connected through a COM port.

6.2.2. C# Demos for PAC Expansion I/O

The PAC SDK includes the following demos that demonstrate the use of the PAC expansion I/O in a C# language environment.

The following demos can be found on the CD that was provided with the package or by downloading the latest version from ICP DAS web site.

CD:\WinPAC_AM335x\wp-8x2x\Demo\PAC\C#\IO\

http://ftp.icpdas.com/pub/cd/winpac_am335x/wp-8x2x/demo/pac/c%23/io/

Folder	Demo	Explanation
Local	find_io	Shows how to retrieve the module names and types which plugged in the WinPAC.
	8k_di	Shows how to read the DI values of DI module. This demo program is used by 8K series DI modules.
	8k_do	Shows how to write the DO values to DO module. This demo program is used by 8K series DO modules.
	8k_dio	Shows how to read the DI and the DO values of the DIO module. This demo program is used by 8K series DIO modules.
	87k_basic	Shows how to send/receive a command/response application. This demo program is used by 87K series modules.
	87K_demo	Shows how use uart API and the IO modules located as slots. This demo program is used by 87K series modules.
	87k_ai	Shows how to read the AI values of AI module. This demo program is used by 87K series AI modules.
	87k_ao	Shows how to write the AO values to AO module. This demo program is used by 87K series AO modules.
	87k_di	Shows how to read the DI values of DI module. This demo program is used by 87K series DI modules.
	87k_do	Shows how to write the DO values to DO module. This demo program is used by 87K series DO modules.
	87k_dio	Shows how to read the DI and the DO values of the DIO module. This demo program is used by 87K series DIO modules.
Remote	7k87k_basic	Shows how to send/receive a command/response application. This demo program is used by 7K or 87K series AI modules which connected through a COM port.

Folder	Demo	Explanation
Remote	7k87k_ai	Shows how to read the AI values of AI module. This demo program is used by 7K or 87K series AI modules which connected through a COM port.
	7k87k_ao	Shows how to write the AO values to AO module. This demo program is used by 7K or 87K series AI modules which connected through a COM port.
	7k87k_di	Shows how to read the DI values of DI module. This demo program is used by 7K or 87K series AI modules which connected through a COM port.
	7k87k_do	Shows how to write the DO values to DO module. This demo program is used by 7K or 87K series AI modules which connected through a COM port.
	7k87k_dio	Shows how to read the DI and the DO values of the DIO module. This demo program is used by 7K or 87K series AI modules which connected through a COM port.

6.2.3. Visual C++ Demos for PAC Expansion I/O

The PAC SDK includes the following demos that demonstrate the use of the PAC expansion I/O in a C# language environment.

The following demos can be found on the CD that was provided with the package or by downloading the latest version from ICP DAS web site.

CD:\WinPAC_AM335x\wp-8x2x\Demo\PAC\Vc2008\IO\

http://ftp.icpdas.com/pub/cd/winpac_am335x/wp-8x2x/demo/pac/vc2008/io/

Folder	Demo	Explanation
Local	find_io	Shows how to retrieve the module names and types which plugged in the WinPAC.
	8k_di	Shows how to read the DI values of DI module. This demo program is used by 8K series DI modules.
	8k_do	Shows how to write the DO values to DO module. This demo program is used by 8K series DO modules.
	8k_dio	Shows how to read the DI and the DO values of the DIO module. This demo program is used by 8K series DIO modules.
	87k_basic	Shows how to send/receive a command/response application. This demo program is used by 87K series modules.
	87K_demo	Shows how use uart API and the IO modules located as slots. This demo program is used by 87K series modules.
	87k_ai	Shows how to read the AI values of AI module. This demo program is used by 87K series AI modules.
	87k_ao	Shows how to write the AO values to AO module. This demo program is used by 87K series AO modules.
	87k_di	Shows how to read the DI values of DI module. This demo program is used by 87K series DI modules.
	87k_do	Shows how to write the DO values to DO module. This demo program is used by 87K series DO modules.
	87k_dio	Shows how to read the DI and the DO values of the DIO module. This demo program is used by 87K series DIO modules.
Remote	7k87k_basic	Shows how to send/receive a command/response application. This demo program is used by 7K or 87K series AI modules which connected through a COM port.

Folder	Demo	Explanation
Remote	7k87k_ai	Shows how to read the AI values of AI module. This demo program is used by 7K or 87K series AI modules which connected through a COM port.
	7k87k_ao	Shows how to write the AO values to AO module. This demo program is used by 7K or 87K series AI modules which connected through a COM port.
	7k87k_di	Shows how to read the DI values of DI module. This demo program is used by 7K or 87K series AI modules which connected through a COM port.
	7k87k_do	Shows how to write the DO values to DO module. This demo program is used by 7K or 87K series AI modules which connected through a COM port.
	7k87k_dio	Shows how to read the DI and the DO values of the DIO module. This demo program is used by 7K or 87K series AI modules which connected through a COM port.

7. WP-8000-CE7 Updates

This chapter provides a guided tour that demonstrates the steps needed to update the WP-8000-CE7 OS and SDKs.

ICP DAS will continue to add additional features to WP-8000-CE7 SDK and OS in the future, so we advise you to periodically check the ICP DAS web site for the latest updates.

The file location of the OS and SDK

Both the files of OS updates and SDK updates can be found on the CD that was provided with the package or by downloading the latest version from ICP DAS web site.

CD:\WinPAC_AM335x\wp-8x2x\
http://ftp.icpdas.com/pub/cd/winpac_am335x/wp-8x2x/

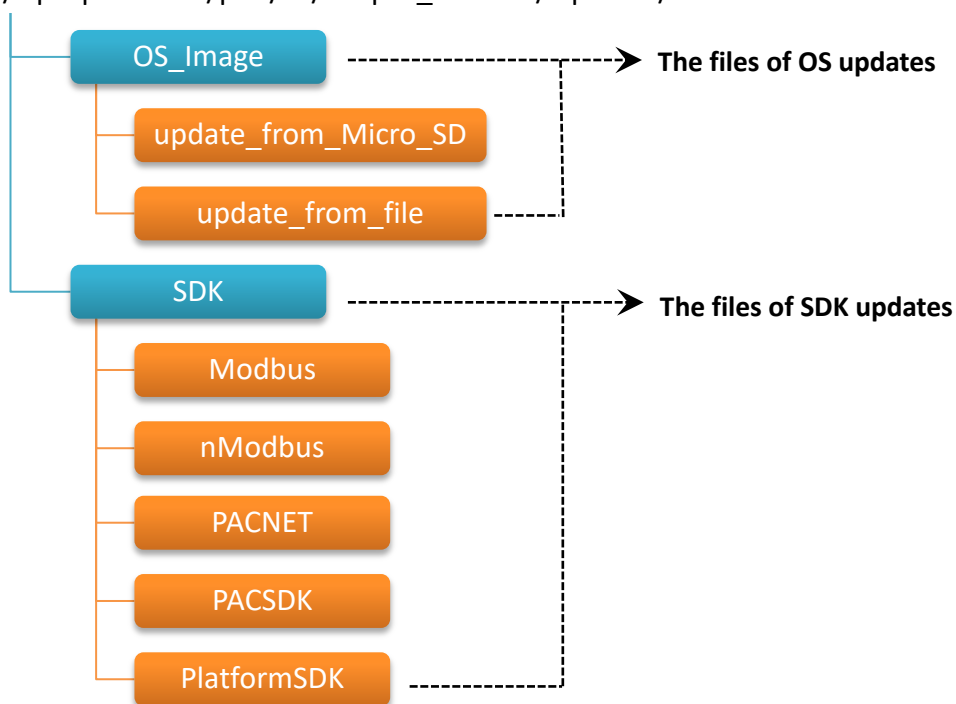

7.1. OS Updates

The latest version of the WP-8000-CE7 OS image can be found separately on the CD that was provided with the package or by downloading the latest version from ICP DAS web site.

CD:\WinPAC_AM335x\wp-8x2x\OS_Image\
http://ftp.icpdas.com/pub/cd/winpac_am335x/wp-8x2x/os_image/

update_from_Eshell_or_Micro_SD
update_from_file

There are two ways to update the OS:

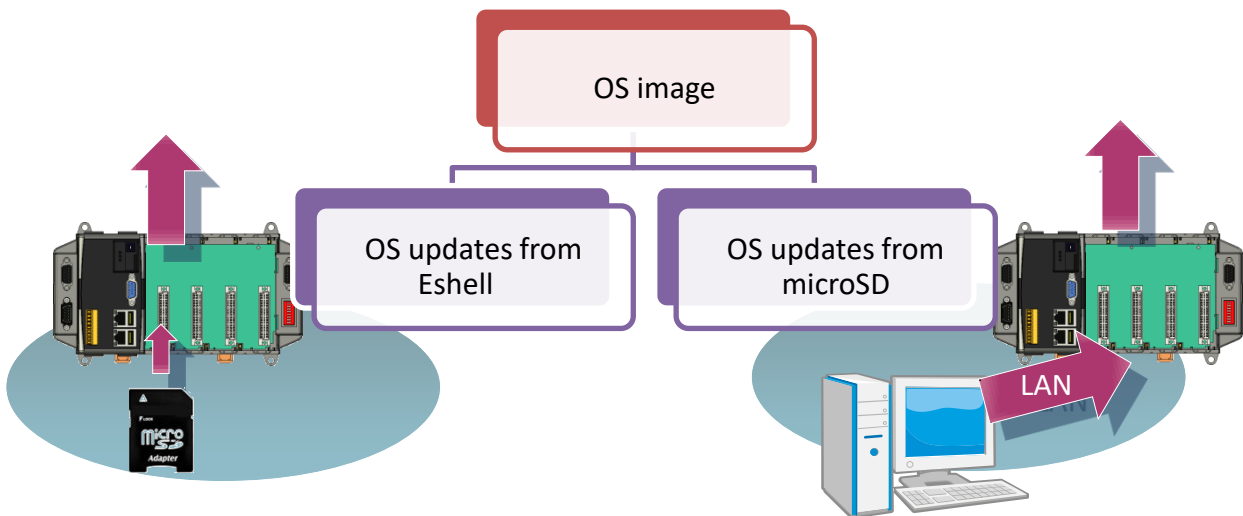

1. OS updates from Eshell (Please refer to section 7.1.1)
(We recommend that you use this one for more quicker and easier to update)
2. OS updates from microSD (Please refer to section 7.1.2)

7.1.1. OS Updates from Eshell

By default, the OS update is updated via a LAN.
Before updating the OS, make sure the LAN is connected to PC.

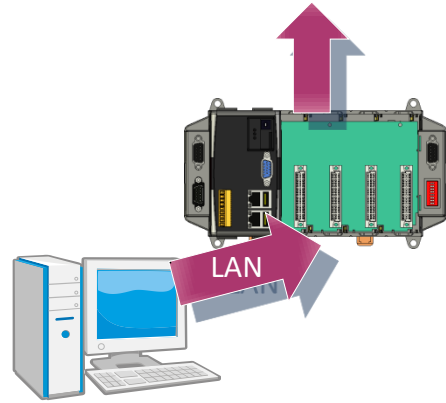

Step 1: Get the latest version of the installation package file and then unzip it

The latest version of the installation package file can be found from ICP DAS web site.

[http://ftp.icpdas.com/pub/cd/winpac_am335x/wp-8x2x/os_image/update_from_eshell_or_micro_sd\](http://ftp.icpdas.com/pub/cd/winpac_am335x/wp-8x2x/os_image/update_from_eshell_or_micro_sd/)

Step 2: Run the registry clear.exe

The registry.exe can be found on the CD that was provided with the package or by downloading the latest version from ICP DAS web site.

CD:\WinPAC_AM335x\WP-8x2x\PC_Tools\Eshell

http://ftp.icpdas.com/pub/cd/winpac_am335x/wp-8x2x/pc_tools/eshell

Step 3: Place the rotary switch in position 3, OS update mode

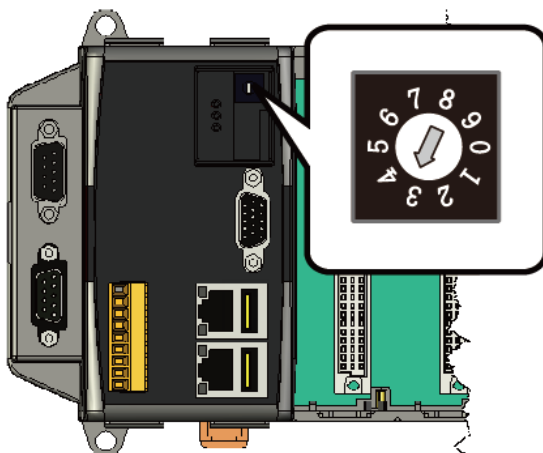

Step 4: Run the ESHELL.exe, and then restart the WP-8000-CE7-CE7

The ESHELL.exe can be found on the CD that was provided with the package or by downloading the latest version from ICP DAS web site.



CD:\WinPAC_AM335x\WP-8x2x\PC_Tools\Eshell

http://ftp.icpdas.com/pub/cd/winpac_am335x/wp-8x2x/pc_tools/eshell

Step 5: Select the device which you want to update the OS image, and then click OK

Select the device name which you want to update the OS image from the list.

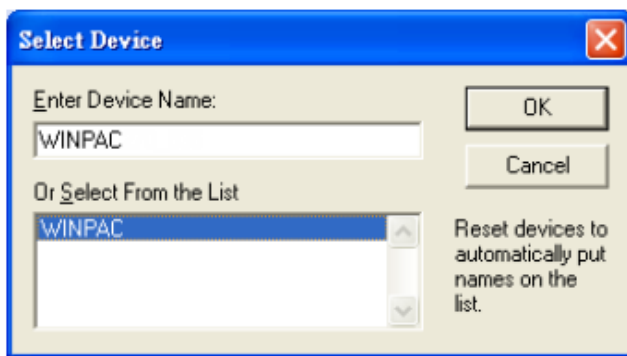

Step 6: Select the latest version of the OS image file

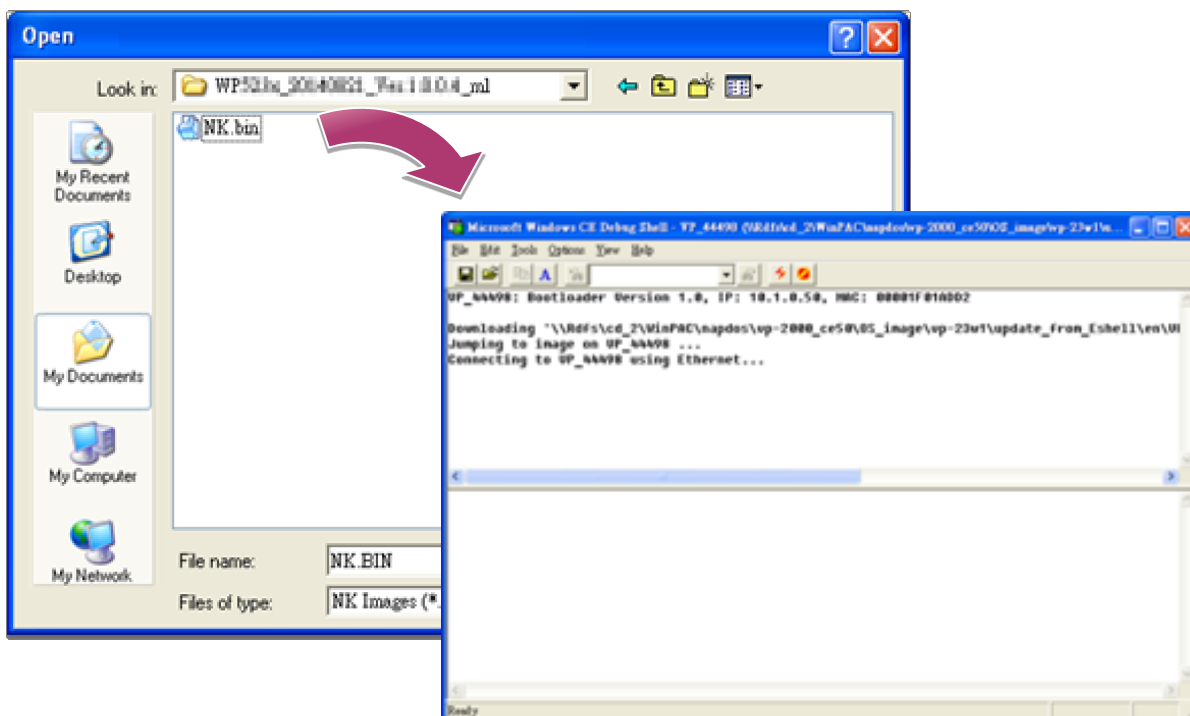

Step 7: Once the procedure is completed, the “Warning !” dialog box will appear as below shown, then turn the rotary switch in position 0, normal mode

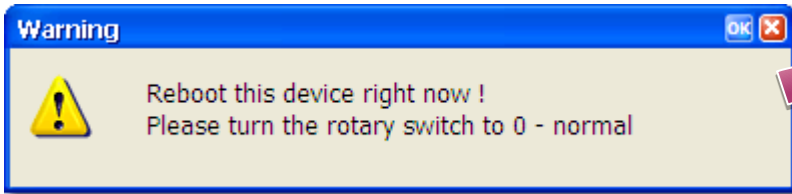

Step 8: Click the OK button

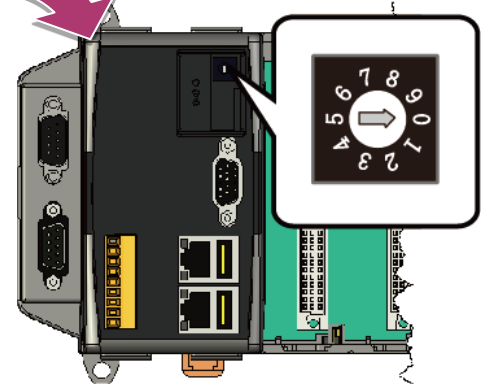
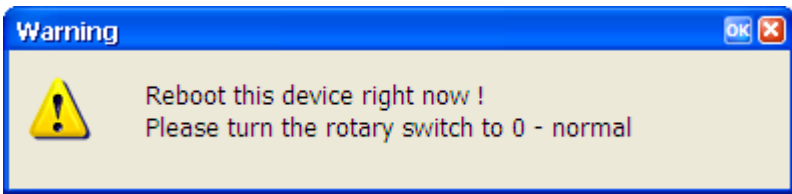

Step 9: Check the OS version

Run the PAC Utility, and then select the Device Information tab to check the current OS version.

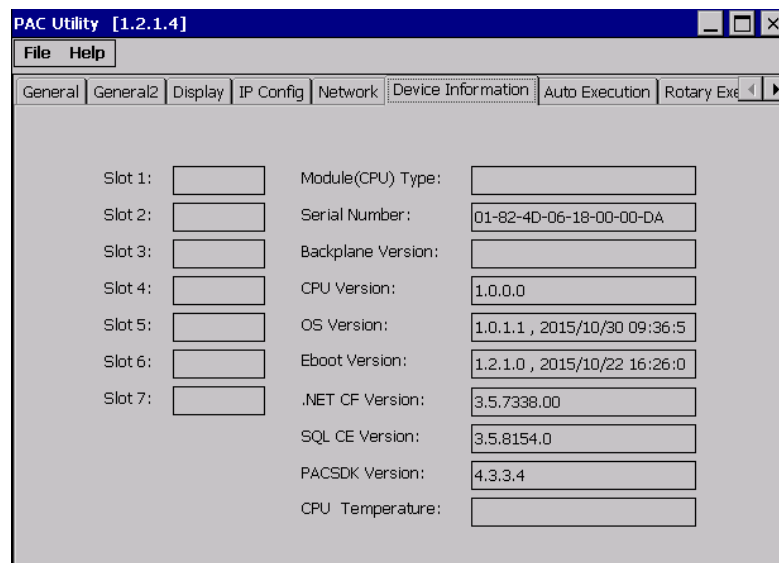

7.1.2. OS updates from microSD

The microSD card can be used to reinstall the WP-8000-CE7 OS image to factory default settings in the event of the WP-8000-CE7 failure.

Step 1: Get the latest version of the installation package file, then unzip the file, and then copy them to microSD card

The latest version of the installation package file can be found from ICP DAS web site.

http://ftp.icpdas.com/pub/cd/winpac_am335x/wp-8x2x/os_image/update_from_eshell_or_micro_sd/

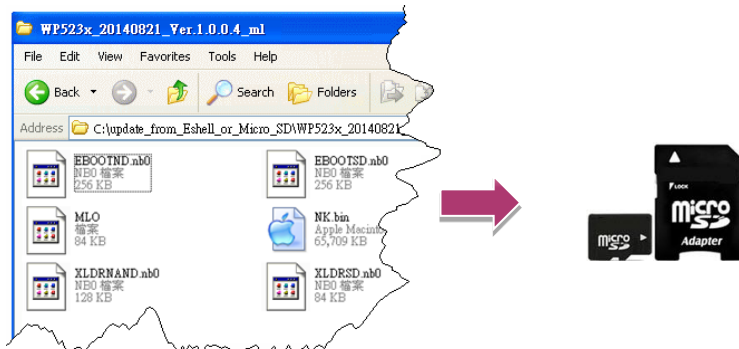

Step 2: Plug the microSD card into SD slot

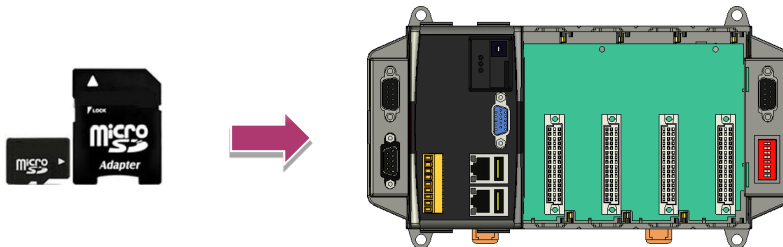

Step 3: Turn the rotary switch in position 5, OS update mode

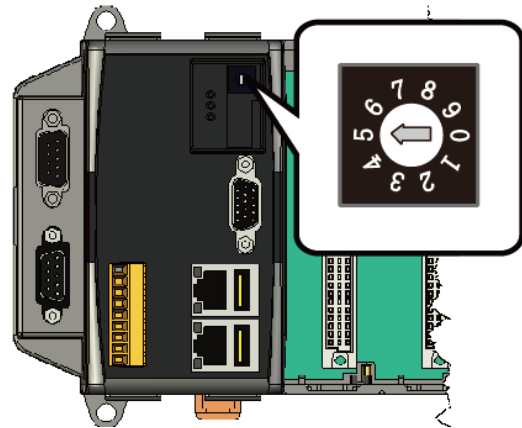

Step 4: Reboot the WP-8000-CE7

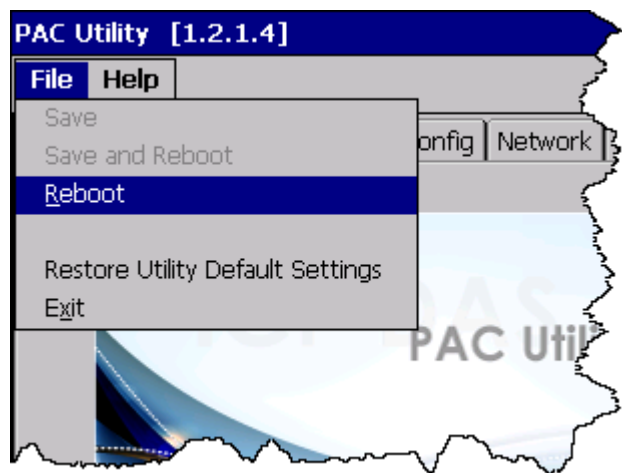

Step 5: Wait a few minutes for the following desktop to be displayed



Step 6: Turn the rotary switch in position 0, normal mode

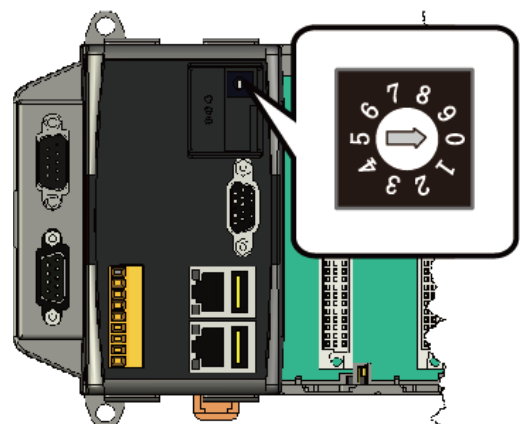

Step 7: Reboot the WP-8000-CE7

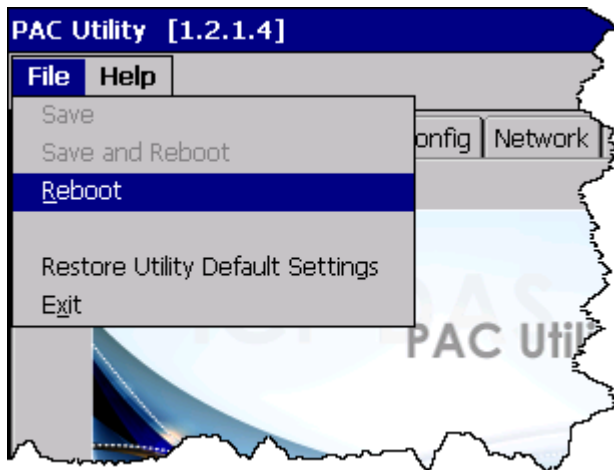

Step 8: Check the OS version

Run the PAC Utility, and then select the Device Information tab to check the current OS version.

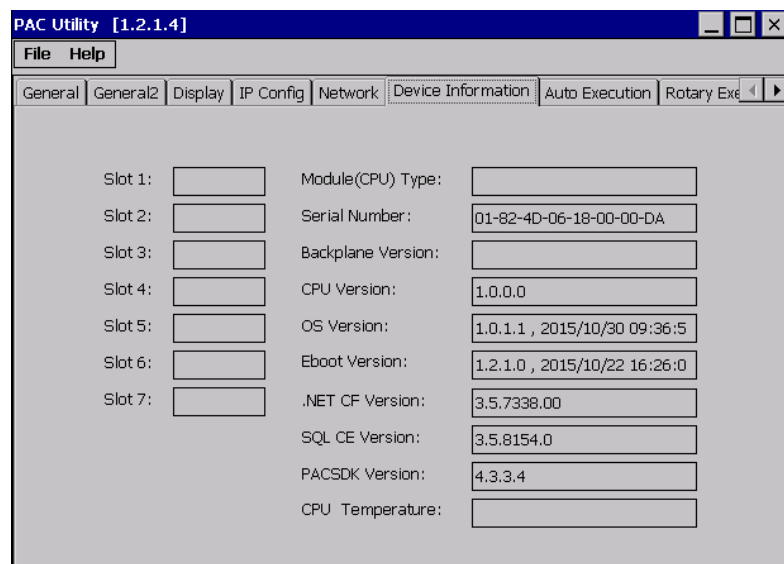

7.2. SDK Updates

SDK update is a part of the WP-8000-CE7 update services to provide additional and more efficient features and functionality for WP-8000-CE7 operating system.

The SDK update files can be found separately on the CD that was provided with the package or by downloading the latest version from ICP DAS web site.

CD:\WinPAC_AM335x\wp-8x2x\SDK\

http://ftp.icpdas.com/pub/cd/winpac_am335x/wp-8x2x/sdk/

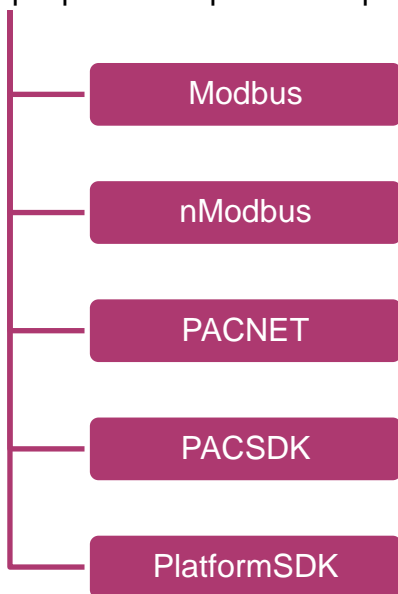

7.2.1. SDK Updates for VB.NET or C#

The SDK can be updated by changing the SDK file.

Step 1: Get the latest version of the PACNET.dll file

The latest version of the PACNET.dll file can be obtained from ICP DAS web site.

http://ftp.icpdas.com/pub/cd/winpac_am335x/wp-8x2x/sdk/pacnet/

Step 2: Copy the latest version of PACNet.dll file to PC and WP-8000-CE7

The PACNET.dll file on PC can be placed anywhere only the solution can reference it.

The PACNET.dll file on WP-8000-CE7 is located at the same directory as the .exe file.

7.2.2. SDK Updates for VB.NET or Visual C++

The SDK can be updated by changing the SDK file.

Step 1: Get the latest version of the VC++ components

The latest version of the VC++ components can be obtained from:

http://ftp.icpdas.com/pub/cd/winpac_am335x/wp-8x2x/sdk/pacsdk/

Step 2: Copy the latest version of header files and libraries to PC

The header files are located at:

C:\Program Files\Windows CE Tools\SDKs\AM335x_WINCE7_SDK\Include\Armv4i

The libraries are located at:

C:\Program Files\Windows CE Tools\SDKs\AM335x_WINCE7_SDK\Lib\ARMv4I

Step 3: Copy the latest version of DLL files to WinPAC

The DLL files are located at:

\System_Disk\ICPDAS\System

8. Download Center

This chapter provides a brief introduction of the WP-8000-CE7 download center.

WP-8000-CE7 has a download center where you can access the latest version of the software, tools, demo programs, and related information.

The WP-8000-CE7 Download Center can be found at:

http://www.icpdas.com/root/support/download/pac/wp-8000-ce7/wp-8000-ce7_download_os_images.html

WP-8000-CE7 Download Center

Note:
When you download the software programs, you should notice if the programs conform to your machine. Before you download any program, please read the notes of each online program first to avoid the confused situation.

OS imagesSDKUtility & ToolsDemoDocumentsSystem DiskFAQ

OS images download

Note:
Before you download the software programs, you should notice if the programs are compatible to your machine. *Please read the notes first in each chapter you want before download programs.*

Touch Panel driver

WP-8000-CE7 provide drivers of PenMount, and ELO touch panels (USB/RS-232). Please download the driver(s) to your WinPAC and double-click it to install the driver.

Touch Panel driver download

Support type	Model	
PenMount USB TOUCH	ADP-1080T-U	
PenMount Serial TOUCH	ADP-1080T-R	
ELO USB TOUCH	ELO USB touch panel	
ELO Serial TOUCH	ELO RS-232 touch panel	

Tips – How to

This chapter provides tips and a guided tour on using and maintaining the WP-8000-CE7.

A. How to Online Debug the WP-8000-CE7 Program

Here are step by step instructions on how to online debug the WP-8000-CE7 program.

Tips & Warnings



Before starting online debug the WP-8000-CE7 program, make sure that the WP-8000-CE7 SDK has been installed correctly.

For more information on how to install the WP-8000-CE7 SDK, please refer to 4.1.2. Installing the WP-8000-CE7 SDK.

Step 1: Copy the following files to the \System_Disk\icpdas\system on the WP-8000-CE7

By default, these files are located on the development computer at C:\Program Files\Common Files\Microsoft Shared\CoreCon\1.0\Target\wce400\<CPU>.

- clientshutdown.exe
- CMAccept.exe
- ConmanClient2.exe
- eDbgTL.dll
- TcpConnectionA.dll

Step 2: Run the ConmanClient2.exe and then CMAccept.exe on the WP-8000-CE7

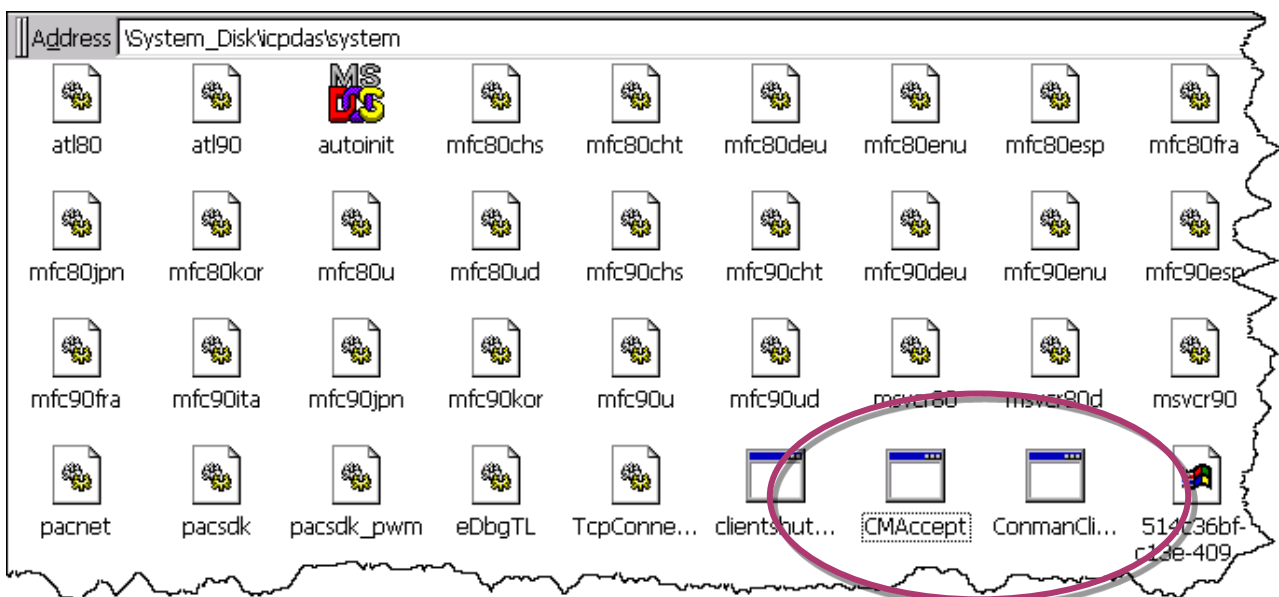

Step 3: On the Tools menu, click the Options

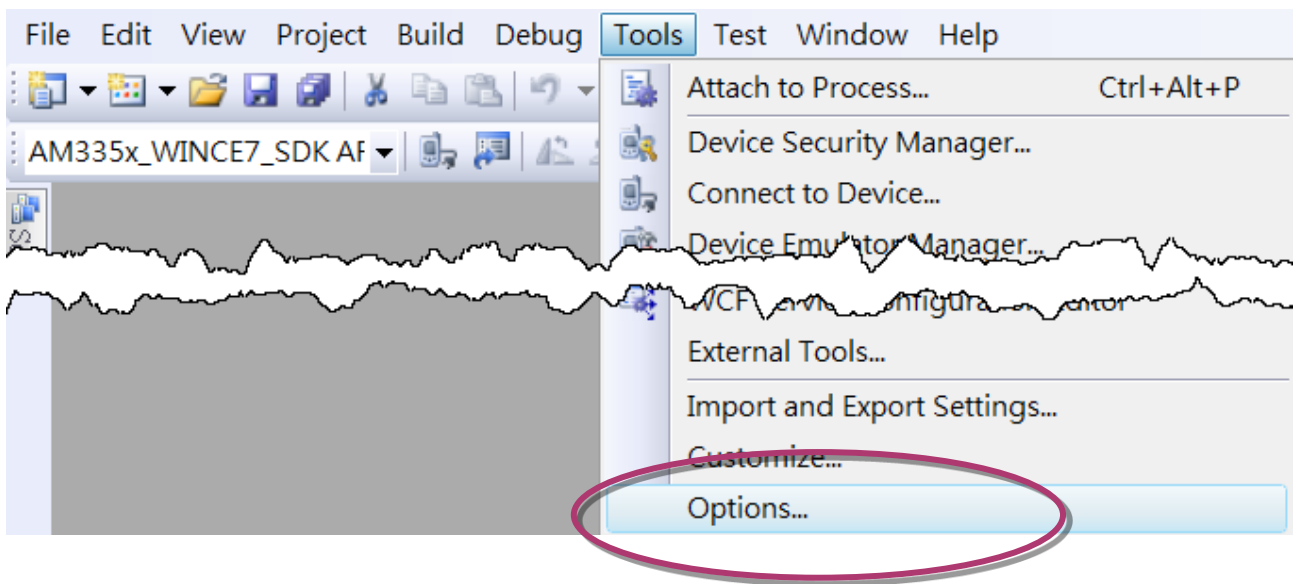

Step 4: In the left pane, expand Device Tools node and select Devices

Step 5: In the Show devices for platform:, select AM335x_WINCE7_SDK and then click Properties

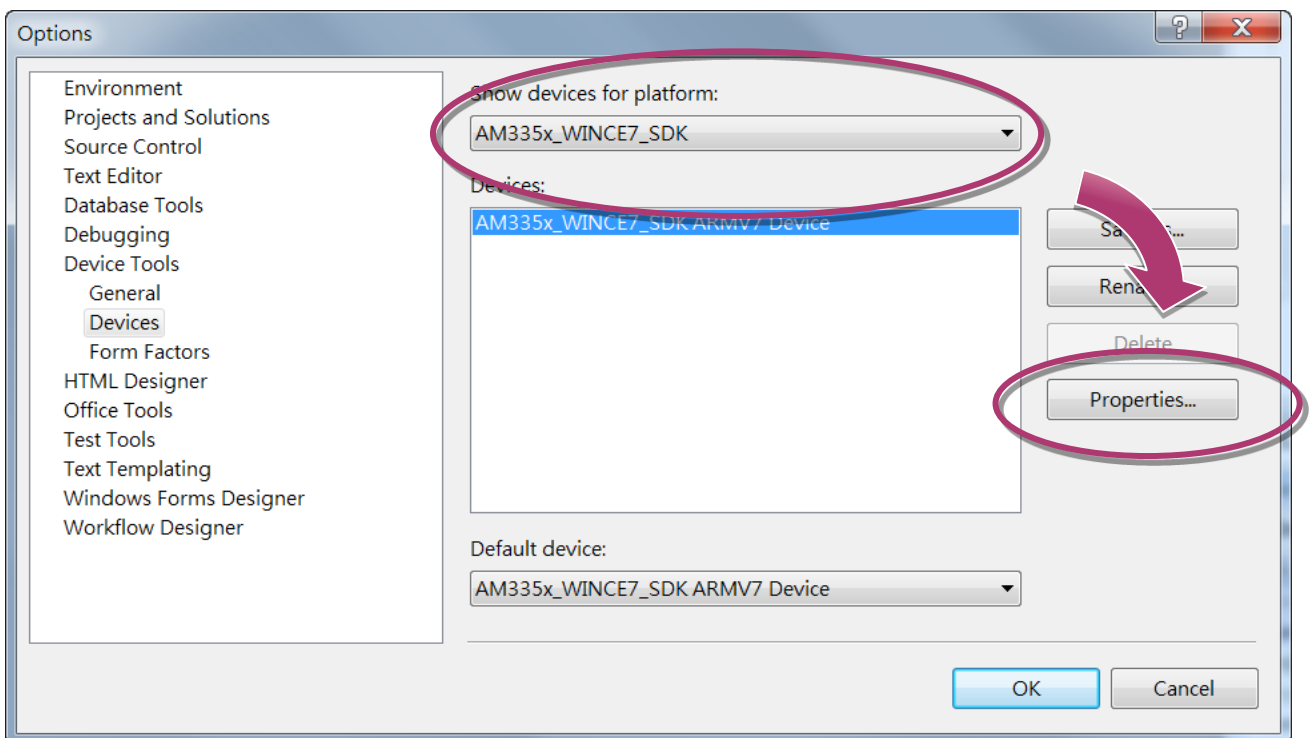

Step 6: Click the Configure...

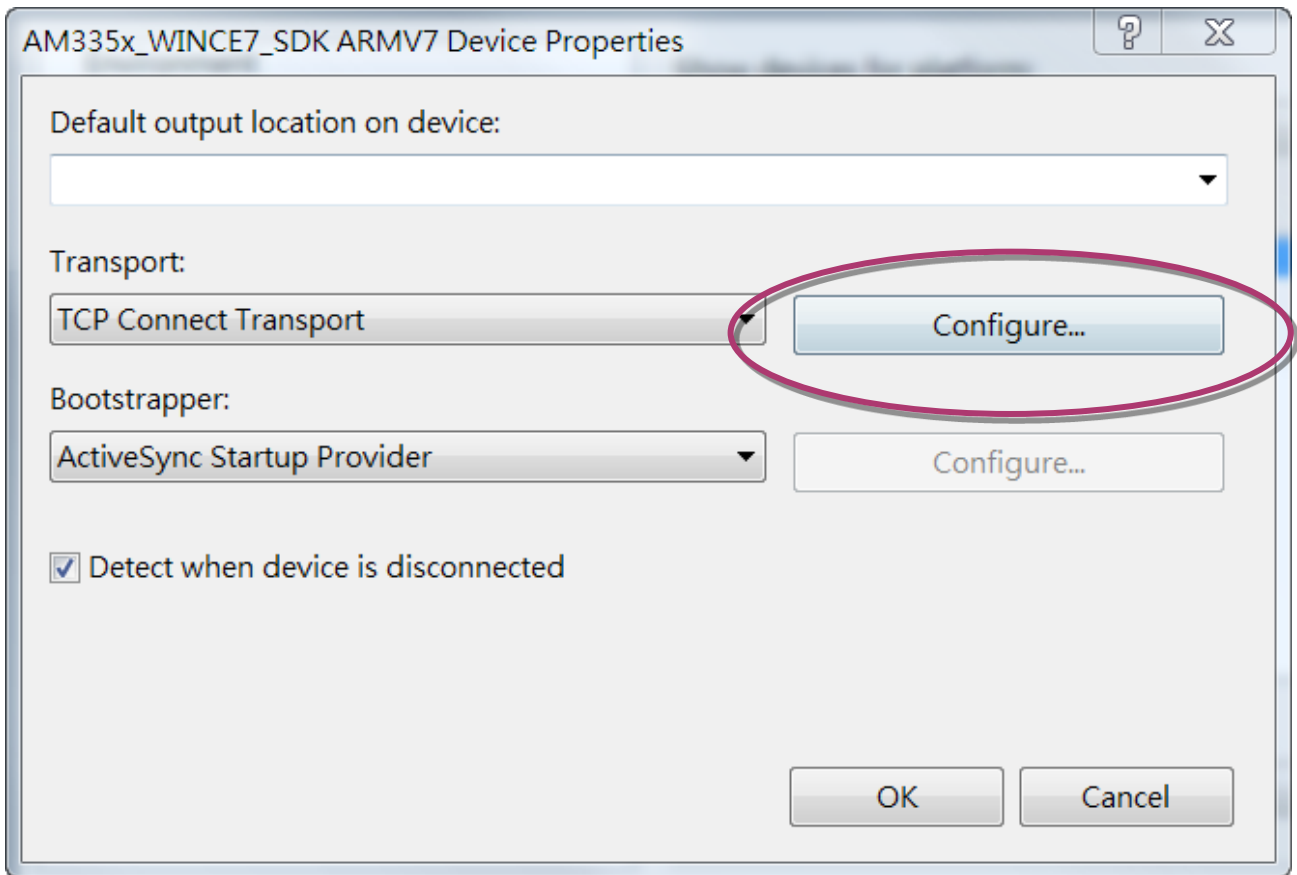

Step 7: Select the Use specific IP address:, and then type the IP address of WP-8000-CE7

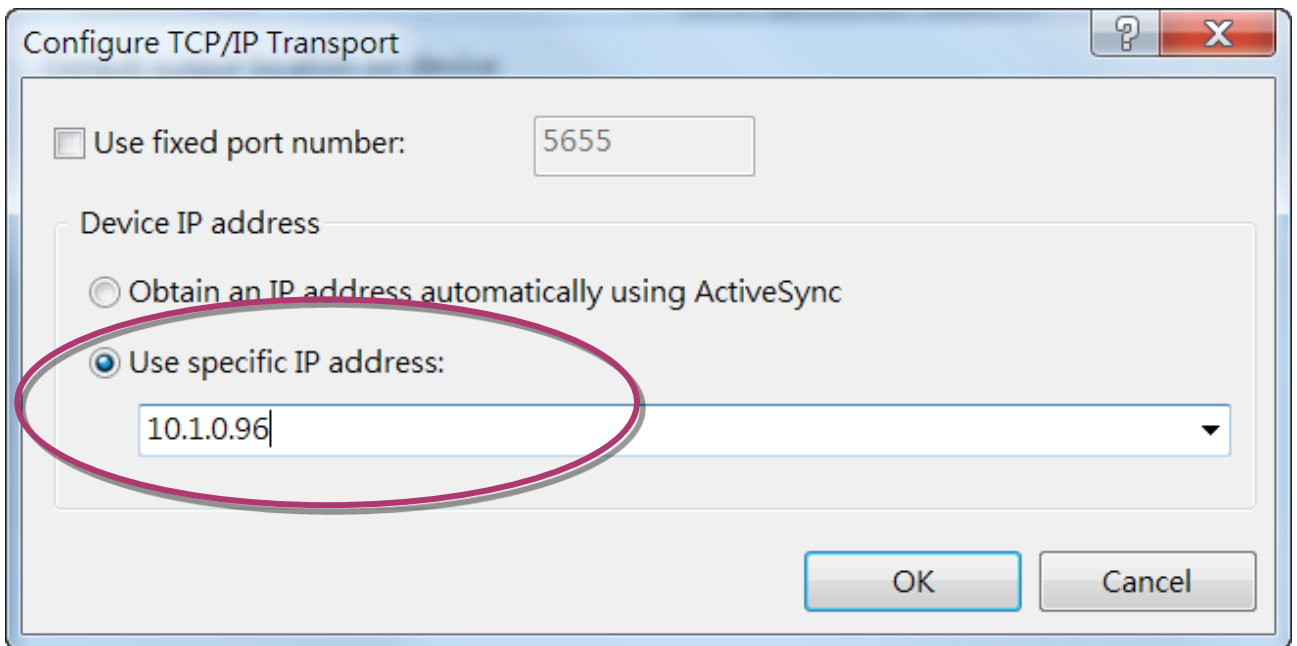

Step 8: Click the OK, and then click OK to end the dialog

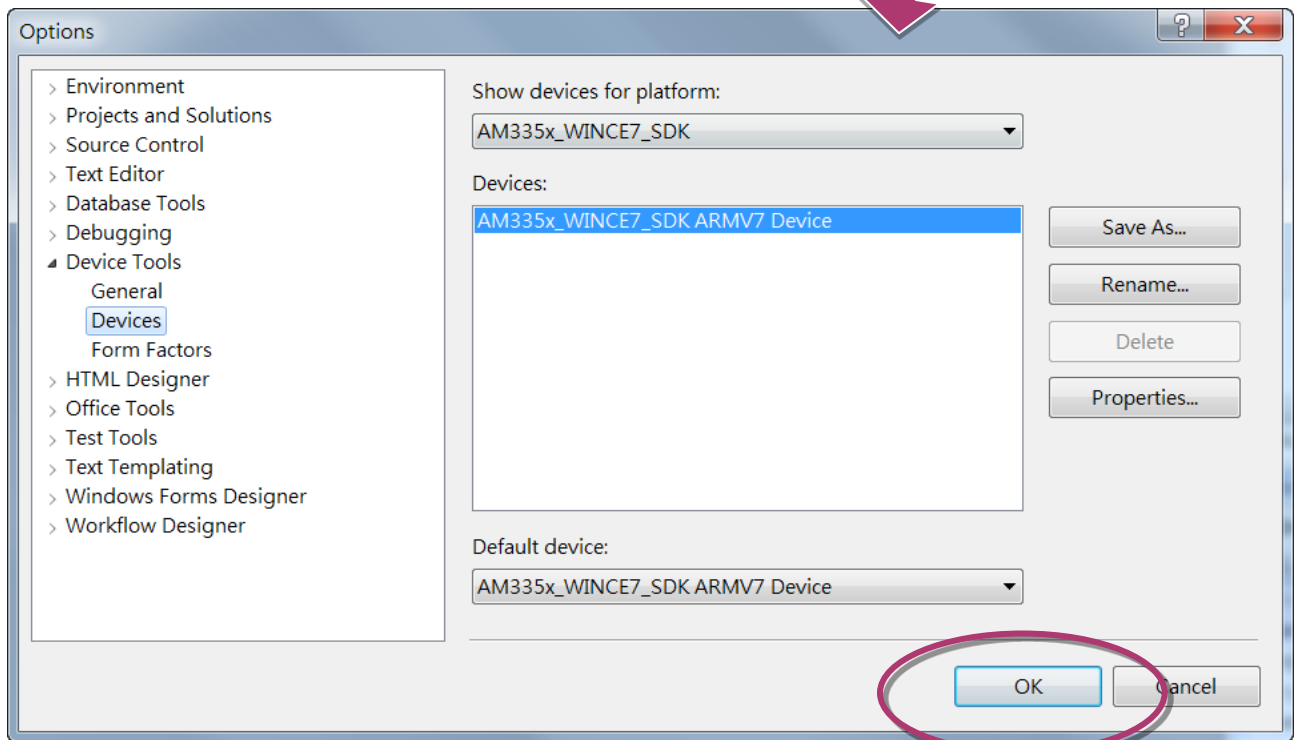
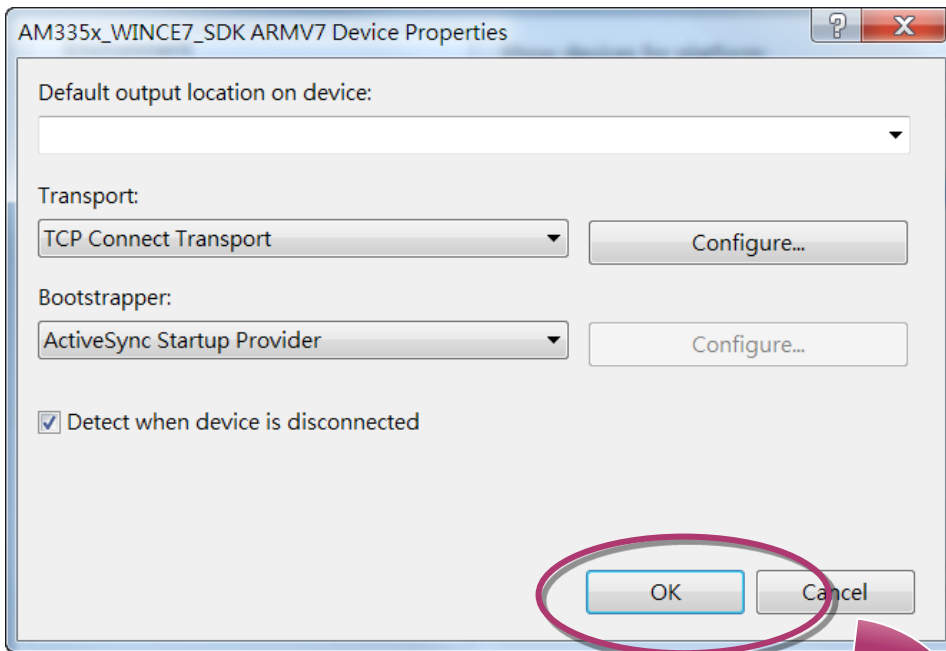

Step 9: On the Tools menu, click the Connect to Device...

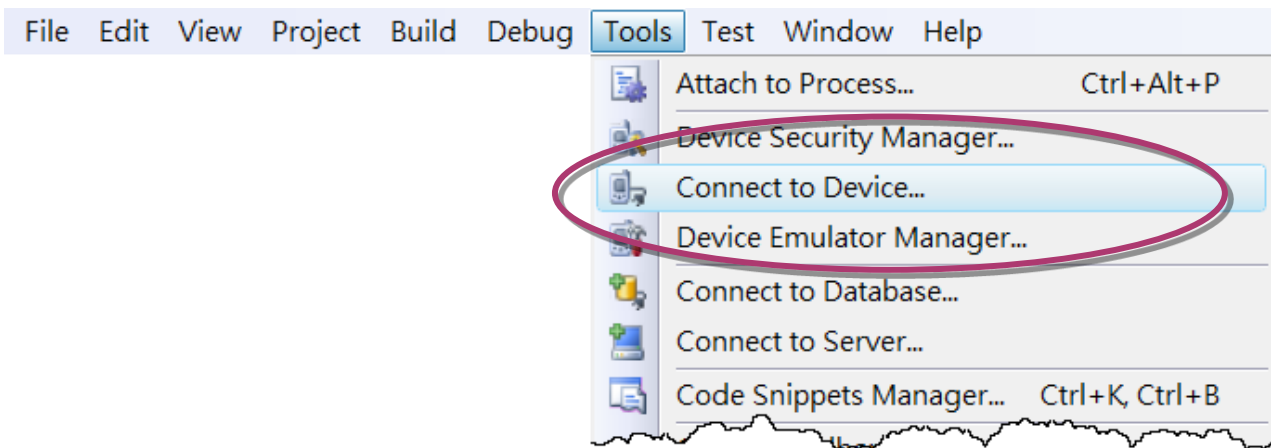

Step 10: Wait for the connection to be established

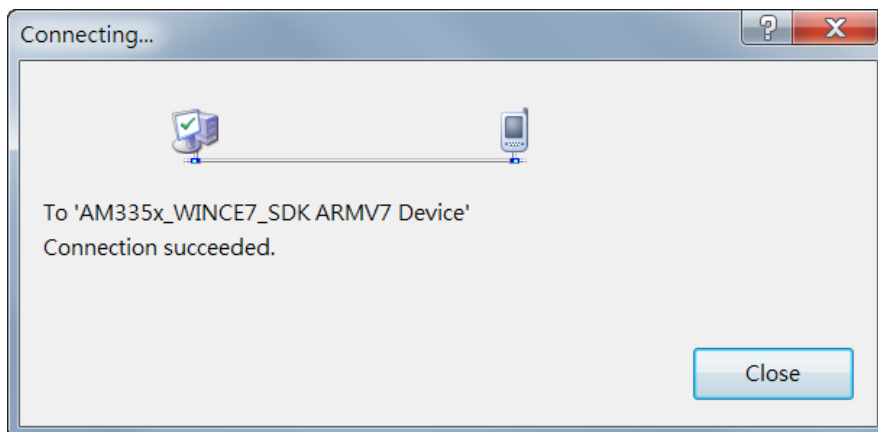

Tips & Warnings



If the connection fails, as shown below, please repeat the step 2 to step 9 to try it again.

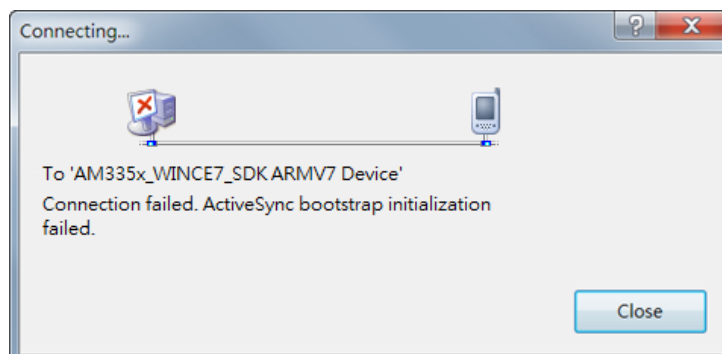

B. How to Automatically Synchronize WP-8000-CE7 Clock with an Internet Time Server

The clock on the WP-8000-CE7 can be synchronized with an internet time server. This means that the clock is updated to match the clock on the time server, which can help ensure that the time on the WP-8000-CE7 is accurate. Here are step by step instructions on how to synchronize the clock on the WP-8000-CE7 with an Internet time server.

Step 1: Run the PAC Utility



Step 2: On the General tab, press Configure button

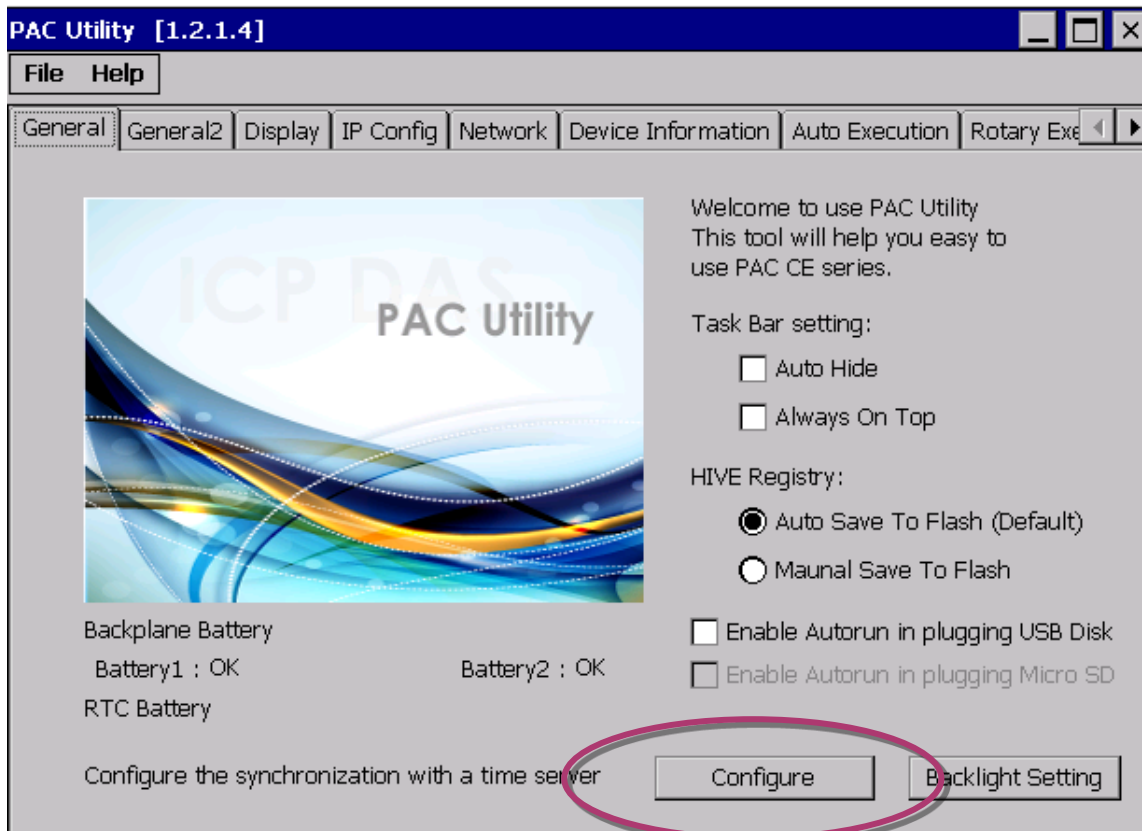

Step 3: Select the domain name from the Server drop-down list, and then enter a value in the Autoupdate Frequency field

Step 4: Check the Automatically synchronize with an internet time server check box

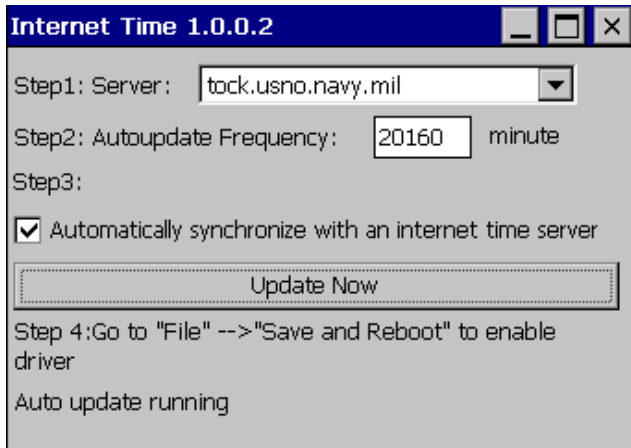

Step 5: On the File menu, click Save and Reboot

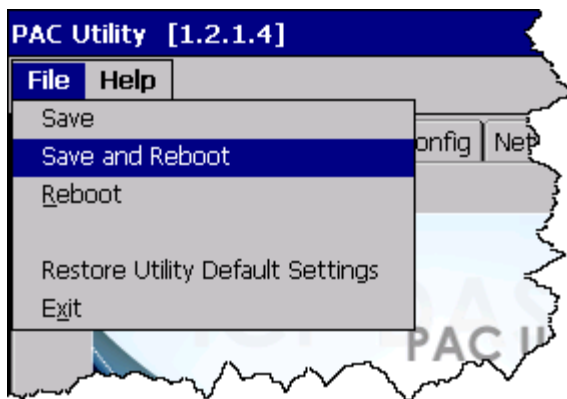

Step 6: The WP-8000-CE7 will automatically synchronize with an internet time server regularly

Step 7: Click the Update Now button to synchronize WP-8000-CE7 clock immediately

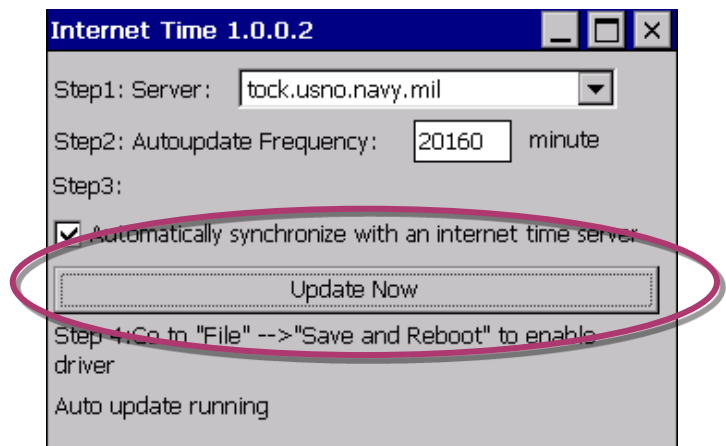

C. How to Control the User Account Control in WP-8000-CE7

User Account Control is a security feature that helps prevent unauthorized system changes to the WP-8000-CE7.

C.1. How to Create a User Account

Here are step by step instructions on how to add a user account.

Step 1: Run the PAC Utility



Step 2: On the Login tab of the Network tab, click Login tab, type the User Name and Password, and then click Add button

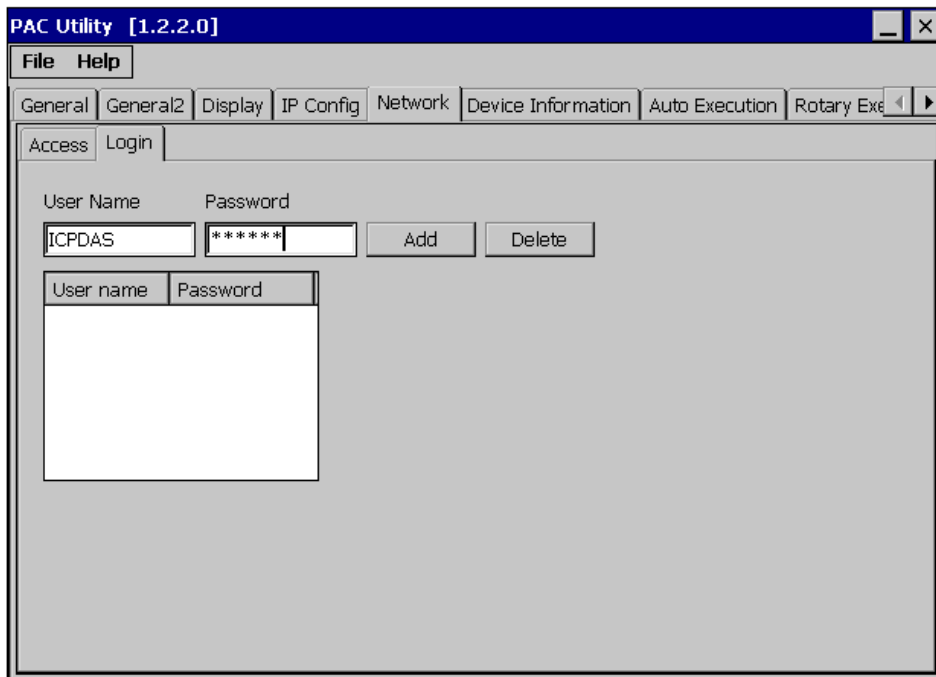

Step 3: The user has been added to the allowed under the remote login and included in the following list

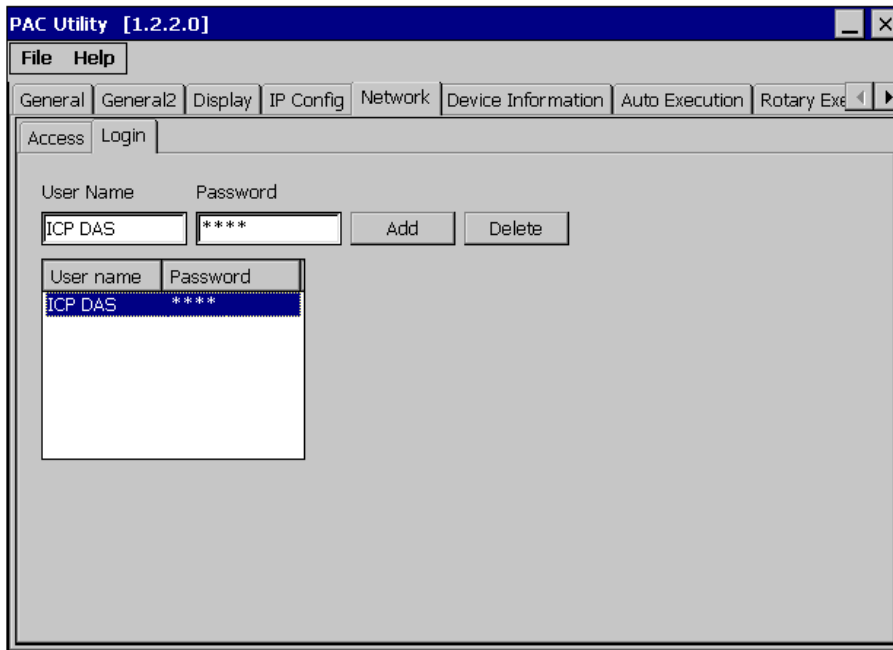

Step 4: On the File menu, click Save and Reboot for changes to take effect

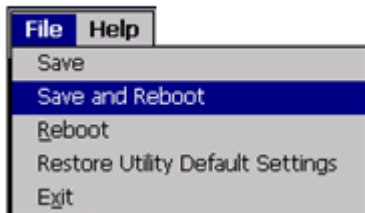

C.2. How to Telnet to Remote Login the WinPAC from PC

Here are step by step instructions on how to use telnet to remote login the WinPAC from PC.

Step 1: On the PC, open a MS-DOS command prompt

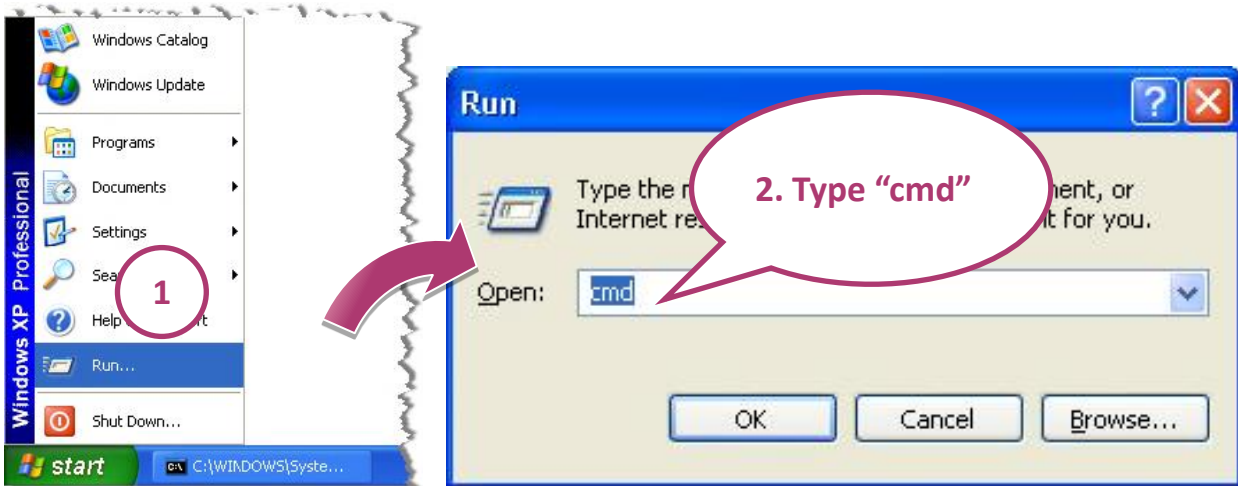

Step 2: At the command prompt, type "telnet (IP address)"

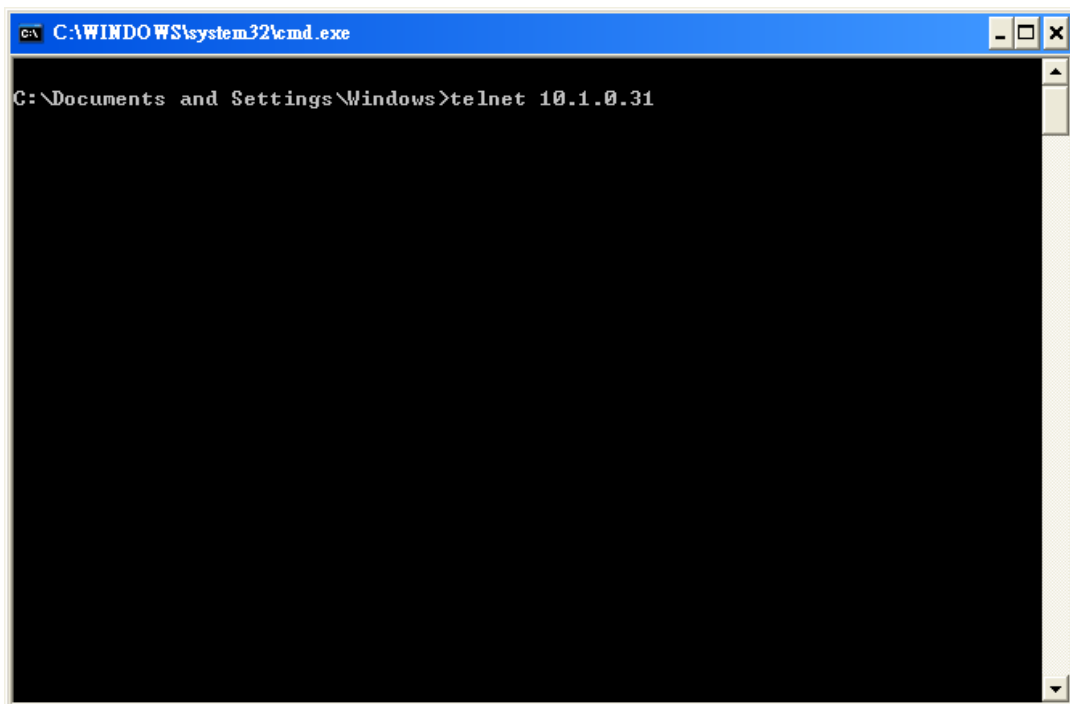

Step 3: The connection has been set up, and then type the name and password

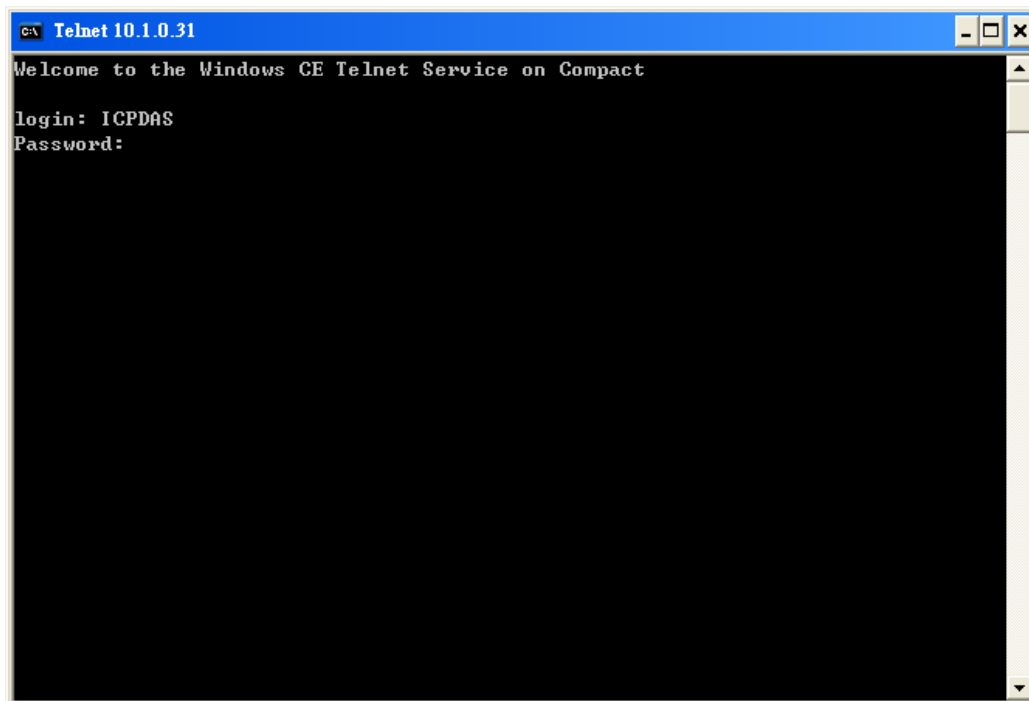

Step 4: The remote login has been completed

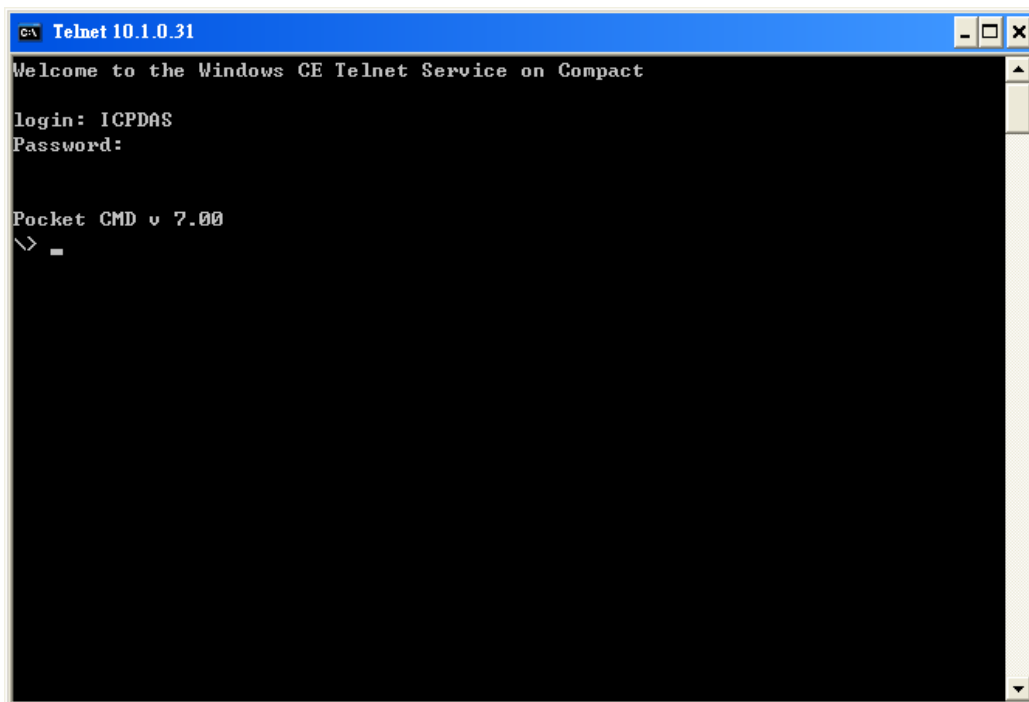

C.3. How to Remove a User Account from the Login List

Here are step by step instructions on how to remote the user from the login list.

Step 1: Click a user from the list which you want to remove, and the user will display in the field, and then press Delete to delete the user from the login list

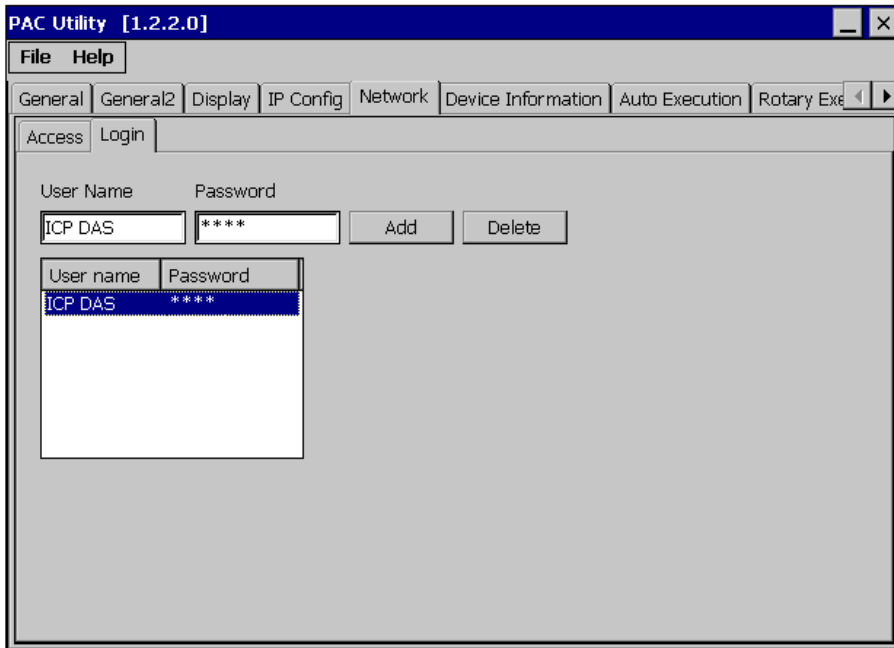

Step 2: On the File menu, click Save and Reboot for changes to take effect

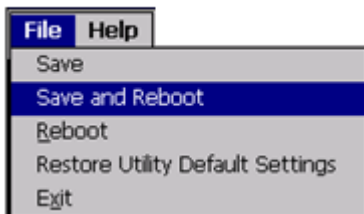

D. How to change the battery

RTC is retained by a Li-ion battery, which can supply continuous power for 10 years. The battery design has the added function of preventing data from being lost while replacing the battery. The following figures show the location of the battery installed in the WinPAC CPU board.

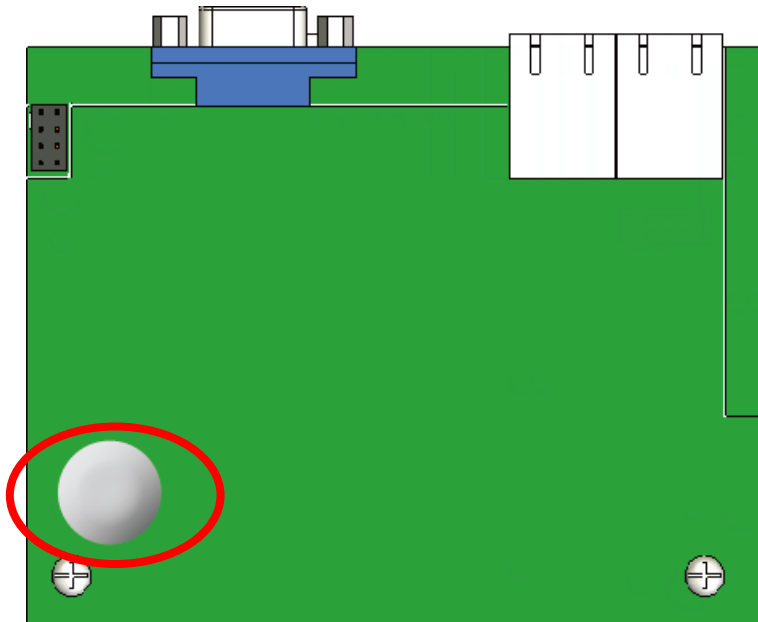

Checking the current battery power

1. Run the PAC utility and check the Battery 1 fields that display the current status. Refer to Section 3.1 PAC utility “General” for more details. If the power level is low that the battery should be replaced.
2. When programming this, call the `pac_GetBatteryLevel()` API function in the `PACSDK.dll` to check whether the battery power is low. When the power of the battery is low, it's recommended that the battery is replaced immediately, otherwise the RTC time will be reset.

Replacing the battery

1. Power off the WinPAC device.
2. Remove the CPU board.
3. Remove the battery that is running low on power from the battery holder in CPU board.
4. Insert a new battery.
5. Set the RTC time.

Ordering information

Battery type: BR1632 (Part number is 2LB010 for ICP DAS)

For more detailed information, contact your local sales office or distributor.

Tips & Warnings



Please ignore the battery on the backplane.

It uses to backward compatible the WP8x4x and WP8x3x device.

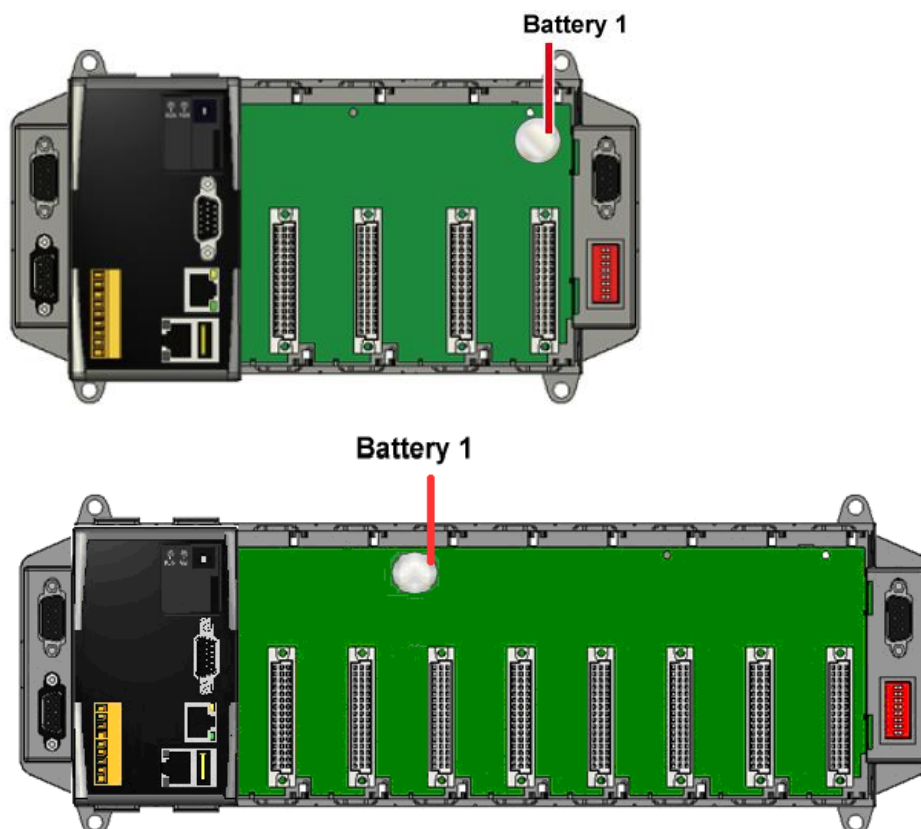

E. How to Using the Practical Functions of the 3G/4G I/O Module

E.1. How to Auto Dial 3G/4G GPRS network and redial when the network disconnected

The AutoDialer allows user to automatically dial GRPS network after boot.
When the GRPS network disconnect the AutoDialer will automatically re-dial Internet access.

Tips & Warnings



Before installing the SIM card, please cancel the PIN lock function of SIM card; otherwise you will not be able to dial the Internet

The demos can be found on the CD that was provided with the package or by downloading the latest version from ICP DAS web site.

CD:\WinPAC_AM335x\wp-5231\demo\3g_modem\autodialer\
http://ftp.icpdas.com/pub/cd/winpac_am335x/wp-5231/demo/3g_modem/autodialer/

The description of the demo can be found by downloading the latest version from ICP DAS web site.

http://ftp.icpdas.com/pub/cd/winpac_am335x/wp-5231/document/faq/development/W5-13_How_to_use_Auto_dial_GPRS_network_and_redial_when_the_network_disconnected_en

E.2. How to Use the SMS Function and Get the GPS Data

The 3G/4G modem allows the user to use the SMS function and get the GPS data.

The API manual can be found by downloading the latest version from ICP DAS web site.

http://ftp.icpdas.com/pub/cd/winpac_am335x/wp-5231/demo/3g_modem/3g_modem_sms_demo/gsm_lib_manual_v1.0.1.pdf

The demos can be found on the CD that was provided with the package or by downloading the latest version from ICP DAS web site.

CD:\WinPAC_AM335x\Wp-5231\demo\3g_modem\3G_modem_SMS_Demo\

http://ftp.icpdas.com/pub/cd/winpac_am335x/wp-5231/demo/3g_modem/3g_modem_sms_demo

The description of the demo can be found by downloading the latest version from ICP DAS web site.

http://ftp.icpdas.com/pub/cd/winpac_am335x/wp-5231/document/faq/development/

W5-14_How_to_use_the_SMS_function_and_get_the_GPS_data_en

E.3. How to Synchronize the System Time by GPS Data

The demos can be found on the CD that was provided with the package or by downloading the latest version from ICP DAS web site.

CD:\WinPAC_AM335x\Wp-5231\demo\3g_modem\gpstimesynchronization\

http://ftp.icpdas.com/pub/cd/winpac_am335x/wp-5231/demo/3g_modem/gpstimesynchronization

The description of the demo can be found by downloading the latest version from ICP DAS web site.

http://ftp.icpdas.com/pub/cd/winpac_am335x/wp-5231/document/faq/development/

W5-15_How_to_Synchronize_the_system_time_by_GPS_data_en

F. Application of RS-485 Network

The RS-485 length can be up to 4000 ft or 1.2 km over a single set of twisted-pair cables, if the RS-485 network is over 4000 ft or 1.2Km, the RS-485 repeater must be added to extend the RS-485 network.

F.1. Basic RS-485 Network

The basic component of the RS-485 network consist of a Master Controller (or using a PC as a host controller), and some RS-485 devices.

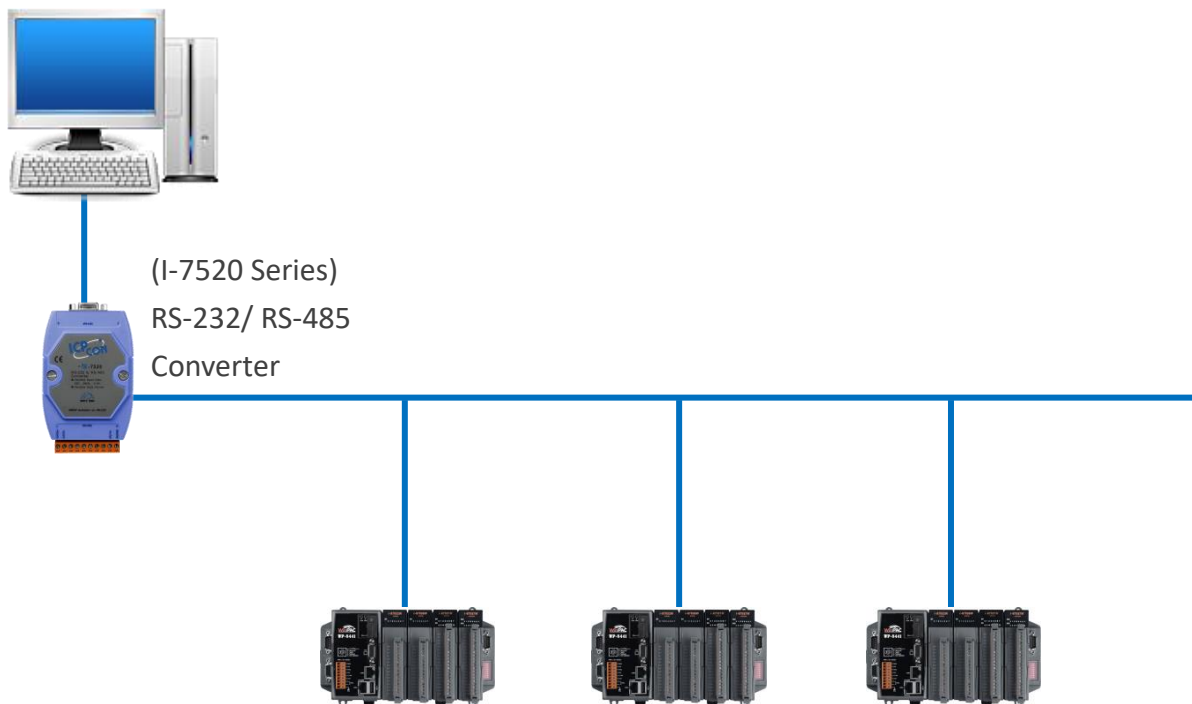

F.2. Daisy Chain RS-485 Network

All RS-485 devices are wired directly to the main network, If the network is up to 1.2 km, it will need a repeater (7510 series) to extend the network length.

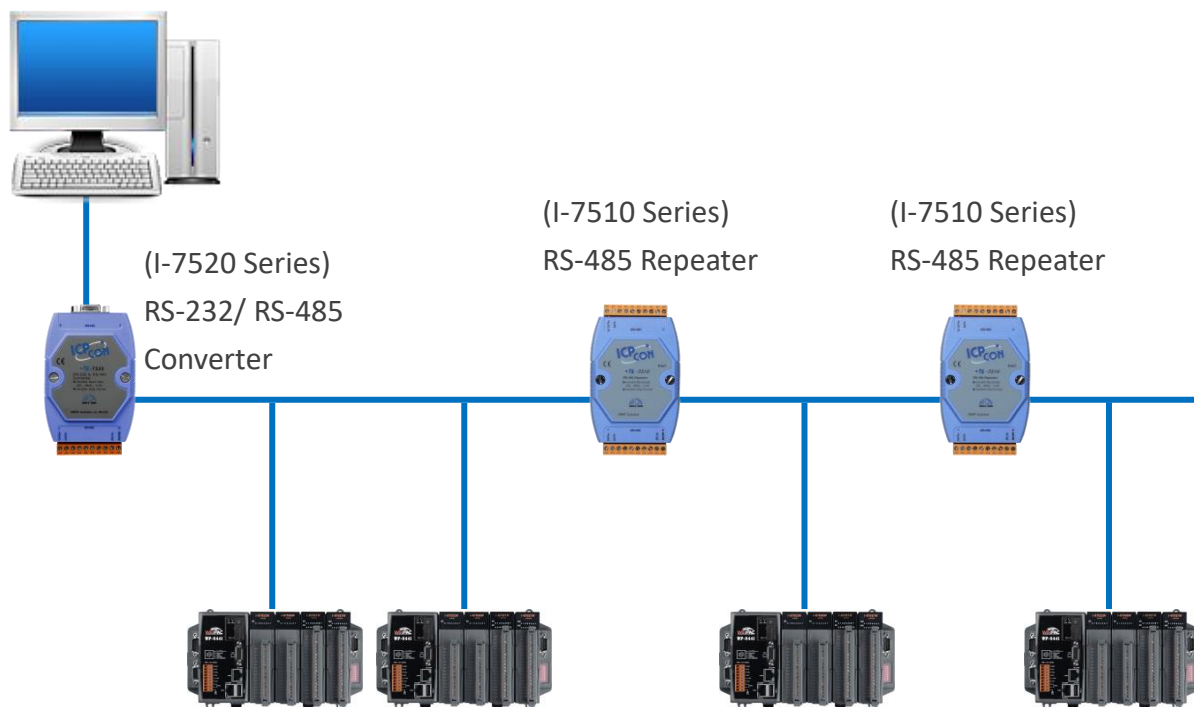

F.3. Star Type RS-485 Network

There are branches along the main network. In this case, it is better to have a repeater to isolate or filter the noise that is made by devices.

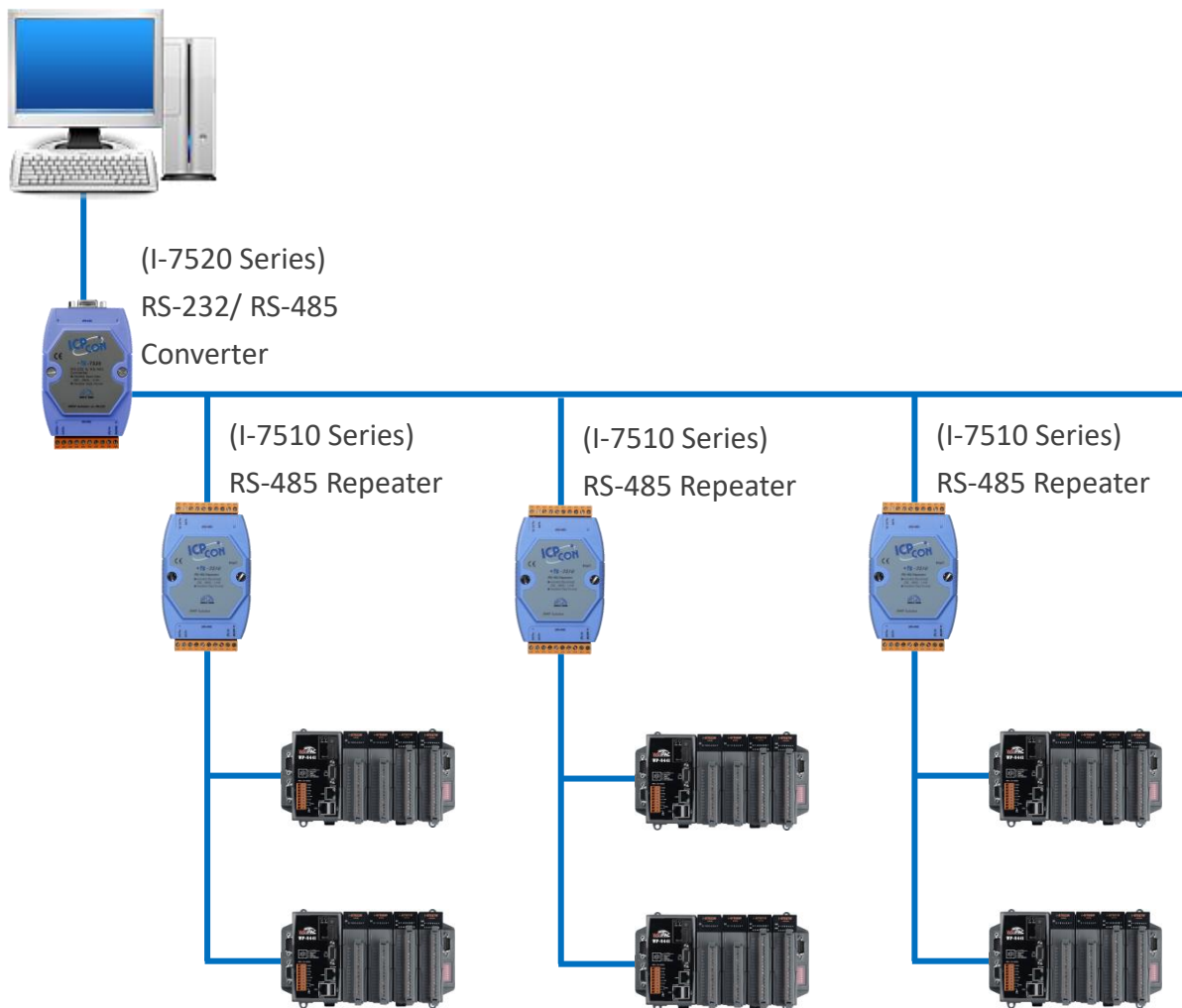

There is a better choice to use 7513 as a RS-485 hub on star type network.

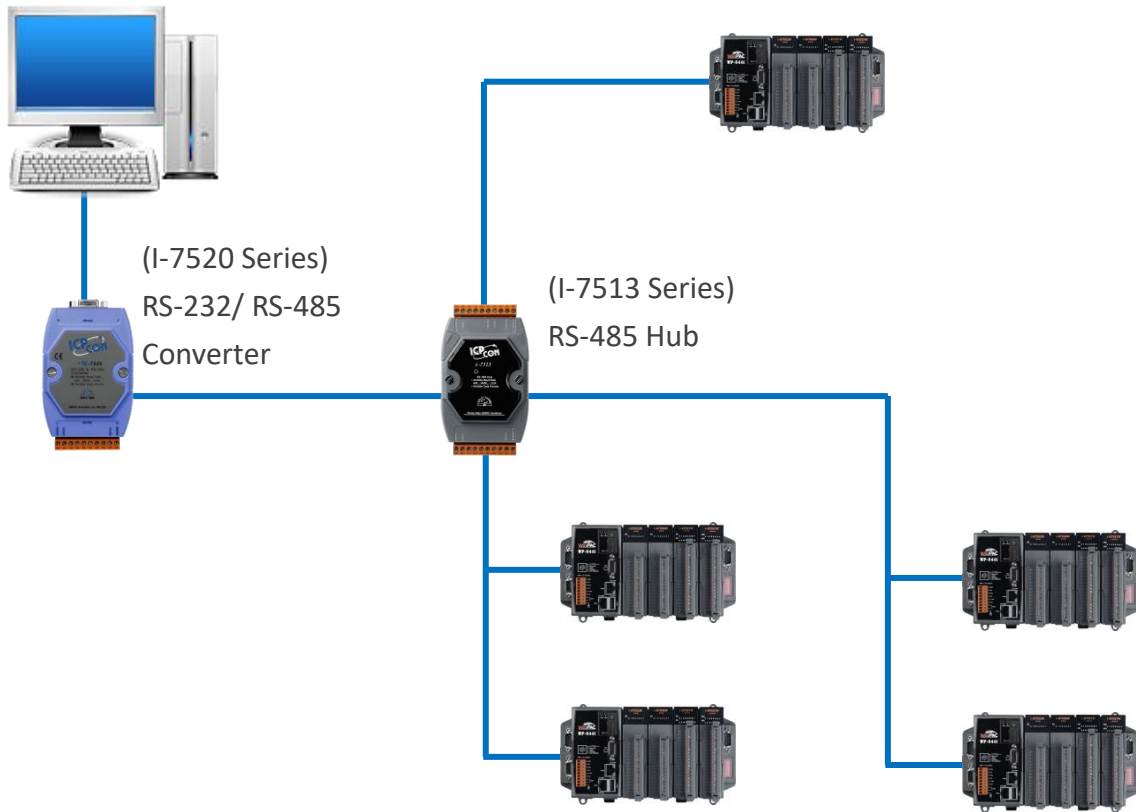

F.4. Random RS-485 Network

There are branches along the main wire. In this case, it is better to have a repeater to isolate or filter the noise that is made by devices.

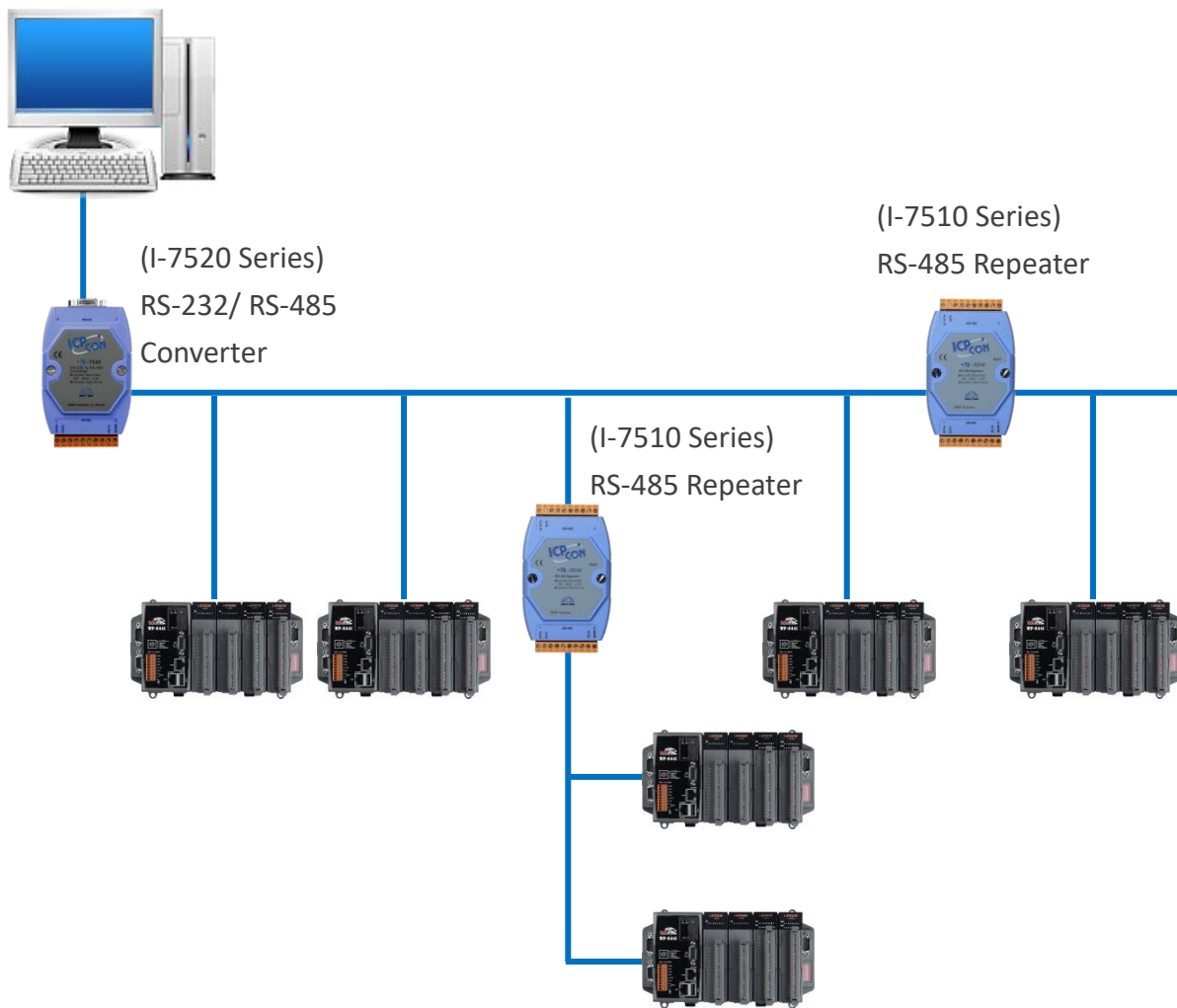

F.5. Master/Slaves Settings

The RS-485 network based on master-slave architecture consists of a single master device and one or more slave devices.

The WinPAC provides two RS-485 communication interfaces based on the master-slave system architecture, all of which have a pull-high/pull-low resistor, user can set it to master or slave for implementing an RS-485 multi-drop network.

One of the RS-485 communications, COM2, its pull-high/pull-low resistor located on power board, the other, COM3, located on the right side and its pull-high/pull-low resistor located on the bottom of the right side, as shown below.

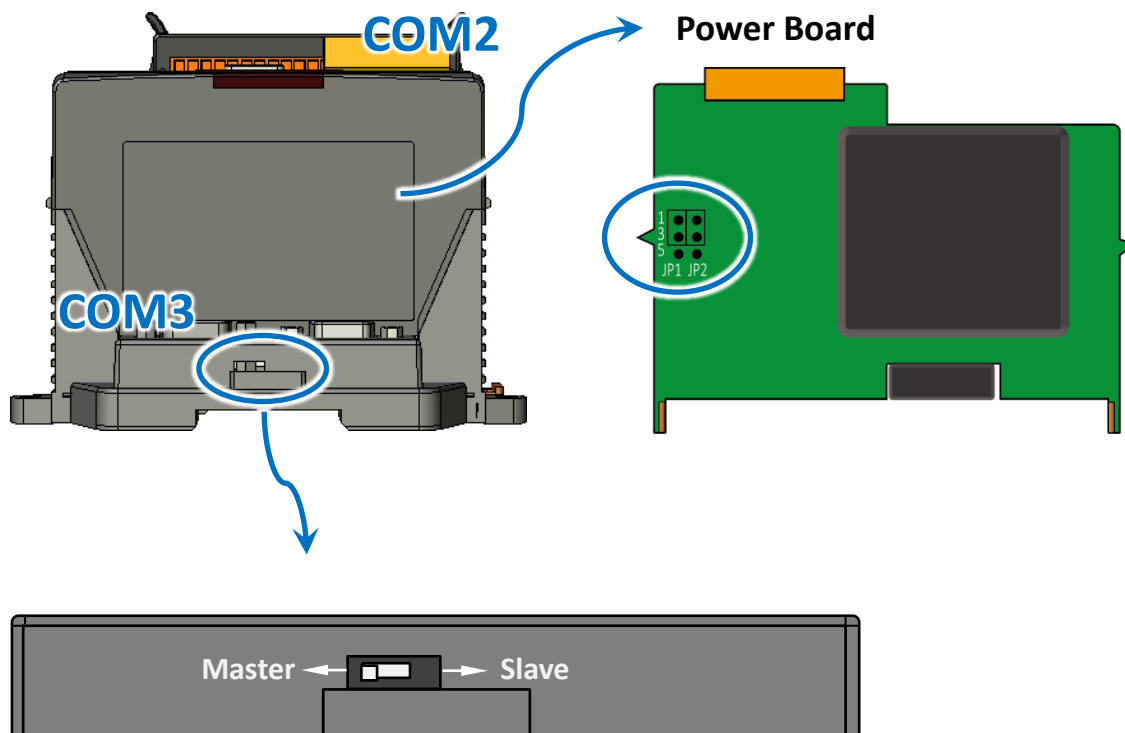

F.5.1. WinPAC acts as a Master (default)

When one of WinPAC is set to master, then all the other devices on the same network must be slave mode. If the network is up to 1.2 KM, it will need a repeater (7510 series) to extend the network length.

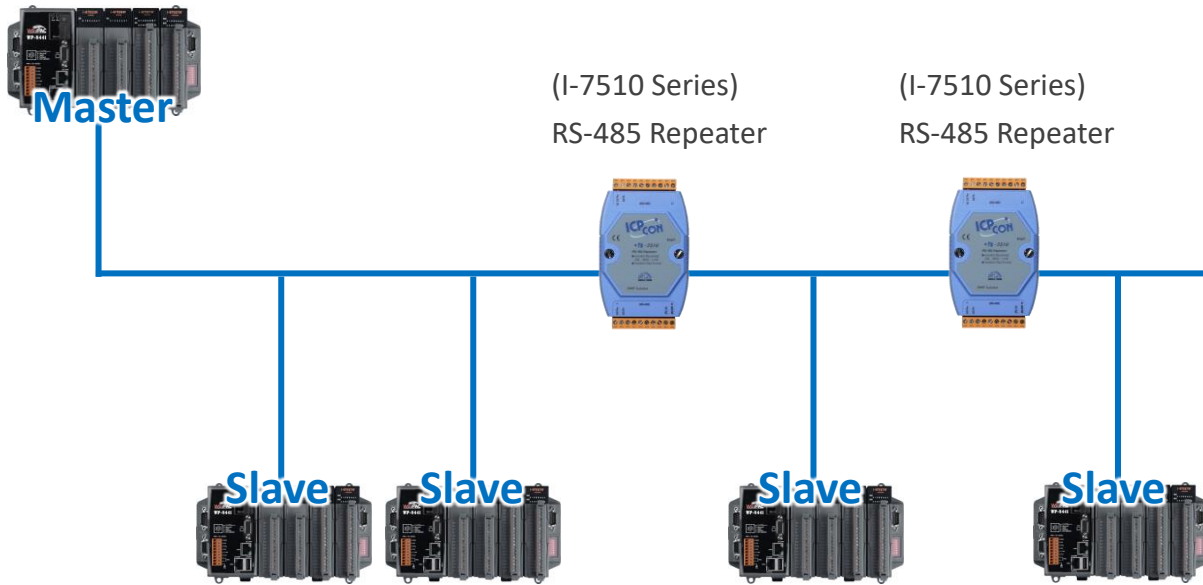

When WinPAC as a master using COM2 communication interface, the pull-high/pull-low resistor located on the power board must adjust to enable as shown below.

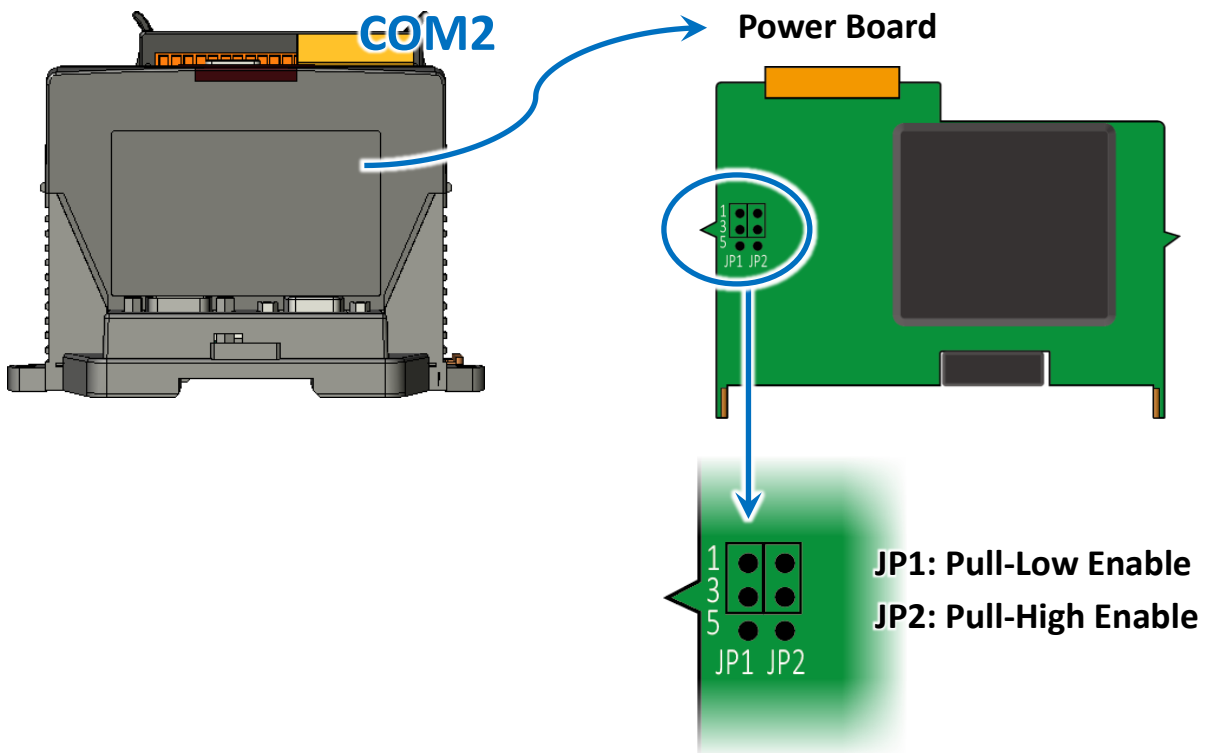

When WinPAC as a master using COM3 communication interface, the pull-high/pull-low resistor located on the power board must adjust to enable as shown below.

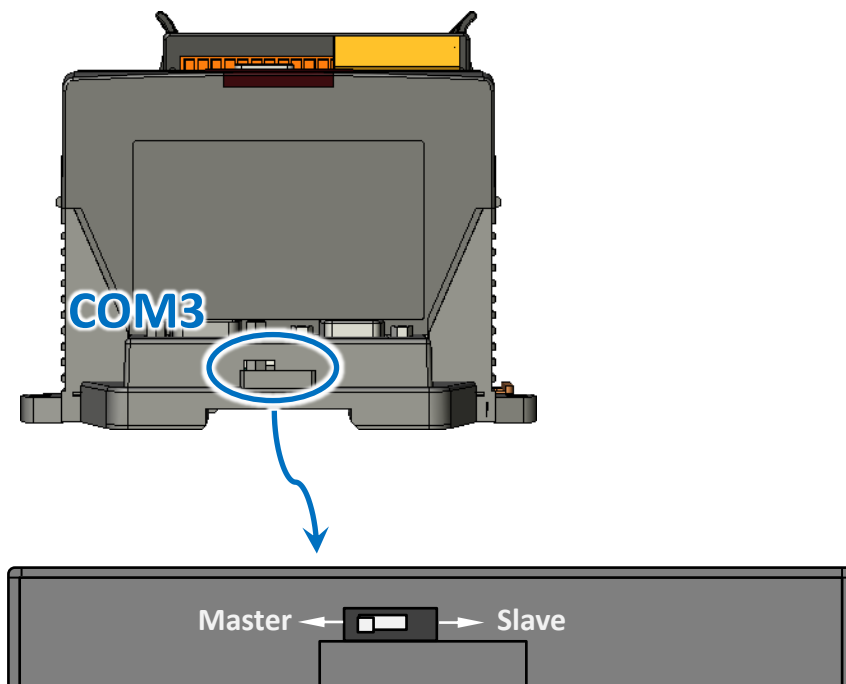

F.5.2. WinPAC acts as a Slave

For most of application, when using one 7520 series as RS-232/485 converter, its pull-high/pull-low resistors are set to enabled. Then the WinPAC-8000 and all the other devices on this network must be slave mode (the pull-high/pull-low resistors must be disabled).

If there are repeaters on the RS-485 network, there will be pull-high/pull-low resistors on both sides of the repeaters (I-7510)

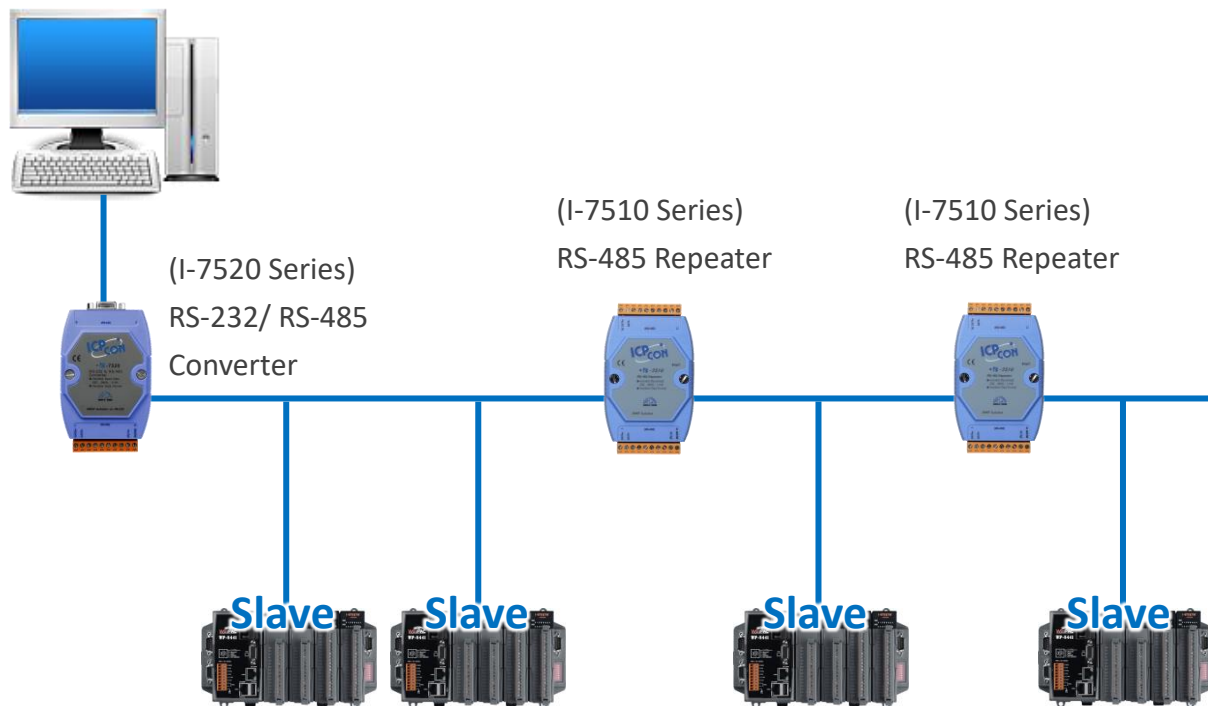

When WinPAC as a slave using COM2 communication interface, the pull-high/pull-low resistor located on the power board must adjust to disabled as shown below.

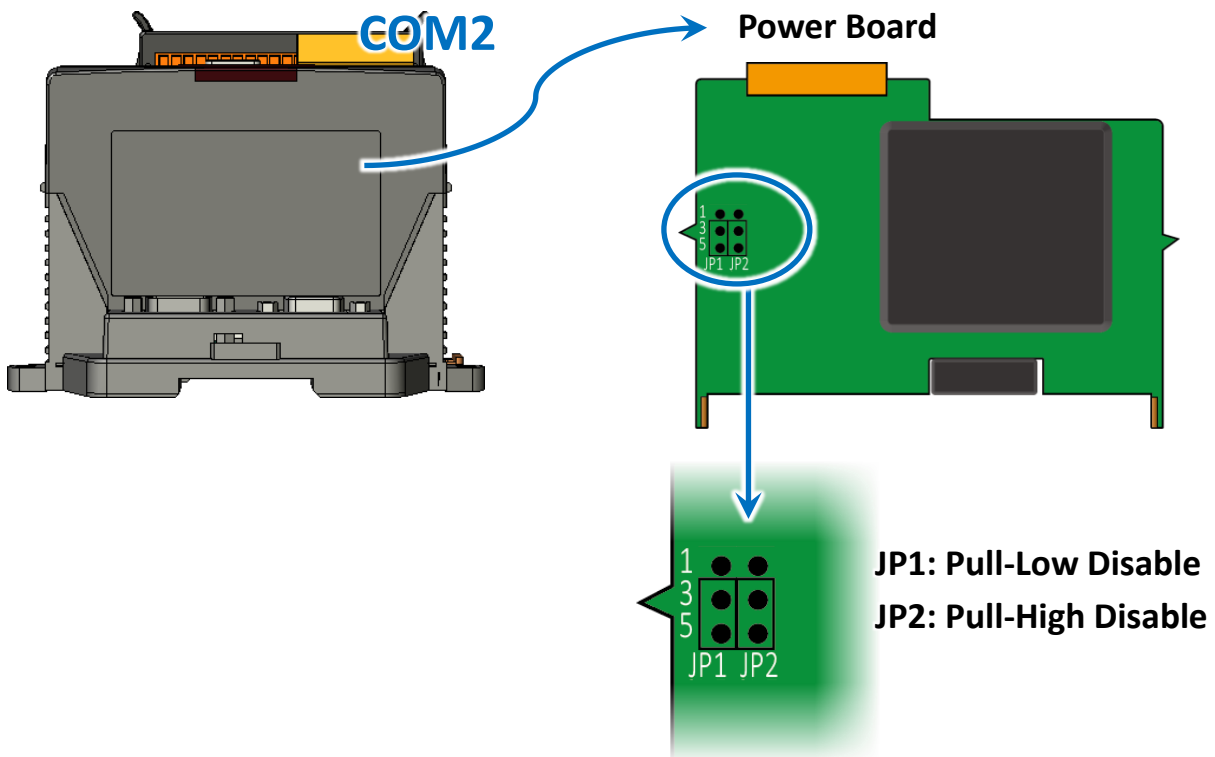

When WinPAC as a slave using COM3 communication interface, the pull-high /pull-low resistor located on the power board must set to “Slave” as shown below.

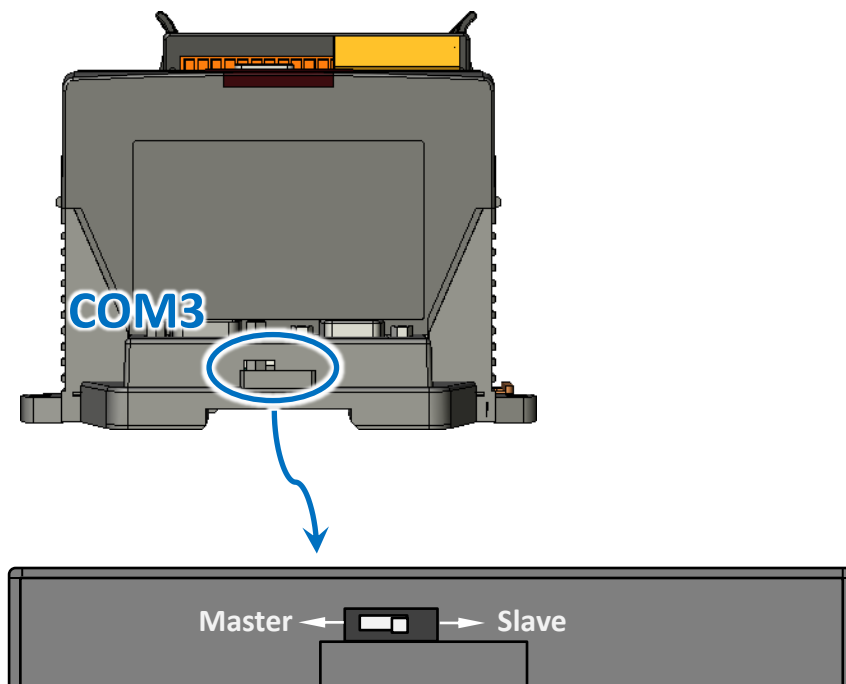

G. Revision History

This chapter provides revision history information to this document.

The table below shows the revision history.

Revision	Release Date	Description
1.0.0	June 2016	Initial issue
1.0.1	June 2016	1. Added the information about how to change the battery in Appendix D. 2. Added the information about the 3G/4G applications in Appendix E.
1.0.2	September 2020	Added the appendix about RS-485 network in Appendix F.